



100mA Positive Voltage Regulator

LM78LXX

Description

The Bay Linear LM78LXX is integrated linear positive regulator with three terminals. The LM78LXX offer several fixed output voltages making them useful in wide range of applications. When used as a zener diode/resistor combination replacement, the LM78LXX usually results in an effective output impedance improvement of two orders of magnitude, lower quiescent current. The voltages available allow the LM78LXX to be used in logic systems, instrumentation, HIFI, and other solid-state electronic equipment.

The LM78LXX is available in the plastic TO-92 (Z) package,

Features

- **Output Current of 100mA**
- **Output Voltage Tolerance of 5%**
- **Internal thermal overload protection**
- **Internal Short-Circuit Limited**
- **No External Component**
- **Output Voltage 5.0V, 6V, 8V, 9V, 10V, 12V, 15V, 18V, 24V**
- **Offer in plastic TO-92**
- **Direct Replacement for LM78L0X /MC78L05**

Applications

- **Post regulator for switching DC/DC converter**
- **Bias supply for analog circuits**

Packaging Information



TO-92 (N)

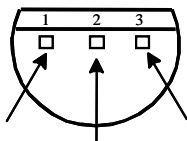

Bottom View

1. Output
2. Common
3. Input

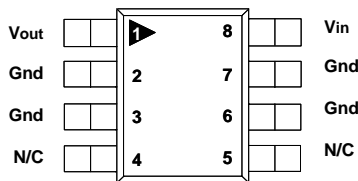

Ordering Information

Device	Operating Voltage	Temp.	Package
LM78I05	7 to 20	0 to 125 °C	TO-92
LM78L06	8 to 20	0 to 125 °C	TO-92
LM78L08	10.5 to 23	0 to 125 °C	TO-92
LM78L09	11.5 to 24	0 to 125 °C	TO-92
LM78L10	12.5 to 25	0 to 125 °C	TO-92
LM78L12	14.5 to 27	0 to 125 °C	TO-92
LM78L15	17.5 to 30	0 to 125 °C	TO-92
LM78L18	20.5 to 33	0 to 125 °C	TO-92
LM78L24	26.5 to 39	0 to 125 °C	TO-92

SO-8 (M)
TO-92 (Z)

Absolute Maximum Rating

Parameter	LM78L05...LM78L10	LM78L12...LM78L18	LM78L24	Unit
Input Voltage	30	35	40	V
Operating Free-Air, Case, Virtual Junction Temp.	0 to 150	0 to 150	0 to 150	°C
Storage Temperature Range	-65 to 150	-65 to 150	-65 to 150	
Lead temperature 1.6 mm from case for sec.	260	260	260	

Electrical Characteristics (LM78L05)

($V_I=10V$, $I_O=40mA$, $0^\circ C \leq T_J \leq 125^\circ C$, $C_1 = 0.33\mu F$, $C_O = 0.1\mu F$, unless otherwise specified. (Note 1))

Parameter	Symbol	Conditions	MIN	TYP	MAX	UNIT
Output Voltage	V_O	$T_J = 25^\circ C$	4.8	5.0	5.2	V
Line Regulation	ΔV_O	$V_I = 7V$ to $20V$ $T_J = 25^\circ C$		32	150	mV
		$V_I = 7V$ to $20V$ $T_J = 25^\circ C$		26	100	
Load Regulation	ΔV_O	$I_O = 1mA$ to $100mA$, $25^\circ C$		15	60	mV
		$I_O = 1mA$ to $40mA$, $25^\circ C$		8	30	
Ripple Rejection	RR	$V_I = 8V$ to $18V$, $f=120Hz$	41	49		dB
Output Noise Voltage	V_N	$F=10Hz$ to $100Hz$ $T_J = 25^\circ C$		46		μV
Dropout Voltage	V_D	$T_J = 25^\circ C$		1.7		V
Quiescent Current		$T_J = 25^\circ C$		3.8	6mA	mA
Quiescent Current Change	ΔI_Q	$V_I = 8V$ to $20V$, $T_J = 25^\circ C$			1.5	mA
		$I_O = 1mA$ to $40mA$, $T_J = 25^\circ C$			0.1	

Electrical Characteristics (LM78L06)

($V_I=10V$, $I_O=40mA$, $0^\circ C \leq T_J \leq 125^\circ C$, $C_1 = 0.33\mu F$, $C_O = 0.1\mu F$, unless otherwise specified. (Note 1))

Parameter	Symbol	Conditions	MIN	TYP	MAX	UNIT
Output Voltage	V_O	$T_J = 25^\circ C$	5.75	6.0	6.25	V
Line Regulation	ΔV_O	$V_I = 8V$ to $20V$ $T_J = 25^\circ C$		35	175	mV
		$V_I = 9V$ to $20V$ $T_J = 25^\circ C$		29	125	
Load Regulation	ΔV_O	$I_O = 1mA$ to $100mA$, $25^\circ C$		16	80	mV
		$I_O = 1mA$ to $40mA$, $25^\circ C$		9	40	
Ripple Rejection	RR	$V_I = 9V$ to $19V$, $f=120Hz$	40	48		dB
Output Noise Voltage	V_N	$F=10Hz$ to $100Hz$ $T_J = 25^\circ C$		46		μV
Dropout Voltage	V_D	$T_J = 25^\circ C$		1.7		V
Quiescent Current		$T_J = 25^\circ C$		3.9	6mA	mA
Quiescent Current Change	ΔI_Q	$V_I = 9V$ to $20V$, $T_J = 25^\circ C$			1.5	mA
		$I_O = 1mA$ to $40mA$, $T_J = 25^\circ C$			0.1	

Electrical Characteristics (LM78L08)

($V_I=10V$, $I_O=40mA$, $0^\circ C \leq T_J \leq 125^\circ C$, $C_1 = 0.33\mu F$, $C_O = 0.1\mu F$, unless otherwise specified. (Note 1))

Parameter	Symbol	Conditions	MIN	TYP	MAX	UNIT
Output Voltage	V_O	$T_J = 25^\circ C$	7.7	8.0	8.3	V
Line Regulation	ΔV_O	$V_I = 10.5V$ to $23V$ $T_J = 25^\circ C$		42	175	mV
		$V_I = 11V$ to $23V$ $T_J = 25^\circ C$		36	125	
Load Regulation	ΔV_O	$I_O = 1mA$ to $100mA$, $25^\circ C$		18	80	mV
		$I_O = 1mA$ to $40mA$, $25^\circ C$		10	40	
Ripple Rejection	RR	$V_I = 13V$ to $23V$, $f=120Hz$	37	46		dB
Output Noise Voltage	V_N	$F=10Hz$ to $100Hz$ $T_J = 25^\circ C$		54		μV
Dropout Voltage	V_D	$T_J = 25^\circ C$		1.7		V
Quiescent Current		$T_J = 25^\circ C$		4.0	6mA	mA
Quiescent Current Change	ΔI_Q	$V_I = 11V$ to $23V$, $T_J = 25^\circ C$			1.5	mA
		$I_O = 1mA$ to $40mA$, $T_J = 25^\circ C$			0.1	

Electrical Characteristics (LM78L09)

($V_I=10V$, $I_O=40mA$, $0^\circ C \leq T_J \leq 125^\circ C$, $C_1 = 0.33\mu F$, $C_O = 0.1\mu F$, unless otherwise specified. (Note 1))

Parameter	Symbol	Conditions	MIN	TYP	MAX	UNIT
Output Voltage	V_O	$T_J = 25^\circ C$	8.6	9.0	9.40	V
Line Regulation	ΔV_O	$V_I = 12V$ to $24V$ $T_J = 25^\circ C$		45	175	mV
		$V_I = 13V$ to $24V$ $T_J = 25^\circ C$		40	125	
Load Regulation	ΔV_O	$I_O = 1mA$ to $100mA$, $25^\circ C$		19	90	mV
		$I_O = 1mA$ to $40mA$, $25^\circ C$		11	40	
Ripple Rejection	RR	$V_I = 15V$ to $25V$, $f=120Hz$	38	45		dB
Output Noise Voltage	V_N	$F=10Hz$ to $100Hz$ $T_J = 25^\circ C$		58		μV
Dropout Voltage	V_D	$T_J = 25^\circ C$		1.7		V
Quiescent Current		$T_J = 25^\circ C$		4	6mA	mA
Quiescent Current Change	ΔI_Q	$V_I = 13V$ to $24V$, $T_J = 25^\circ C$			1.5	mA
		$I_O = 1mA$ to $40mA$, $T_J = 25^\circ C$			0.1	

Electrical Characteristics (LM78L10)

($V_I=10V$, $I_O=40mA$, $0^\circ C \leq T_J \leq 125^\circ C$, $C_1 = 0.33\mu F$, $C_O = 0.1\mu F$, unless otherwise specified. (Note 1))

Parameter	Symbol	Conditions	MIN	TYP	MAX	UNIT
Output Voltage	V_O	$T_J = 25^\circ C$	9.6	10	10.4	V
Line Regulation	ΔV_O	$V_I = 13V$ to $25V$ $T_J = 25^\circ C$		51	175	mV
		$V_I = 13V$ to $25V$ $T_J = 25^\circ C$		42	125	
Load Regulation	ΔV_O	$I_O = 1mA$ to $100mA$, $25^\circ C$		20	90	mV
		$I_O = 1mA$ to $40mA$, $25^\circ C$		11	40	
Ripple Rejection	RR	$V_I = 15V$ to $25V$, $f=120Hz$	37	44		dB
Output Noise Voltage	V_N	$F=10Hz$ to $100Hz$ $T_J = 25^\circ C$		62		μV
Dropout Voltage	V_D	$T_J = 25^\circ C$		1.7		V
Quiescent Current		$T_J = 25^\circ C$		4.2	6mA	mA
Quiescent Current Change	ΔI_Q	$V_I = 14V$ to $25V$, $T_J = 25^\circ C$			1.5	mA
		$I_O = 1mA$ to $40mA$, $T_J = 25^\circ C$			0.1	

Electrical Characteristics (LM78L12)

($V_I=10V$, $I_O=40mA$, $0^\circ C \leq T_J \leq 125^\circ C$, $C_1 = 0.33\mu F$, $C_O = 0.1\mu F$, unless otherwise specified. (Note 1))

Parameter	Symbol	Conditions	MIN	TYP	MAX	UNIT
Output Voltage	V_O	$T_J = 25^\circ C$	11.50	12	12.5	V
Line Regulation	ΔV_O	$V_I = 14V$ to $27V$ $T_J = 25^\circ C$		55	250	mV
		$V_I = 14V$ to $27V$ $T_J = 25^\circ C$		49	200	
Load Regulation	ΔV_O	$I_O = 1mA$ to $100mA$, $25^\circ C$		22	100	mV
		$I_O = 1mA$ to $40mA$, $25^\circ C$		13	50	
Ripple Rejection	RR	$V_I = 15V$ to $25V$, $f=120Hz$	37	42		dB
Output Noise Voltage	V_N	$F=10Hz$ to $100Hz$ $T_J = 25^\circ C$		70		μV
Dropout Voltage	V_D	$T_J = 25^\circ C$		1.7		V
Quiescent Current		$T_J = 25^\circ C$		4.3	6.5mA	mA
Quiescent Current Change	ΔI_Q	$V_I = 16V$ to $27V$, $T_J = 25^\circ C$			1.5	mA
		$I_O = 1mA$ to $40mA$, $T_J = 25^\circ C$			0.1	

Electrical Characteristics (LM78L15)

($V_I=10V$, $I_O=40mA$, $0^\circ C \leq T_J \leq 125^\circ C$, $C_1 = 0.33\mu F$, $C_O = 0.1\mu F$, unless otherwise specified. (Note 1))

Parameter	Symbol	Conditions	MIN	TYP	MAX	UNIT
Output Voltage	V_O	$T_J = 25^\circ C$	14.40	15	15.60	V
Line Regulation	ΔV_O	$V_I = 17.5V$ to $30V$ $T_J = 25^\circ C$		65	250	mV
		$V_I = 17.5V$ to $30V$ $T_J = 25^\circ C$		58	300	
Load Regulation	ΔV_O	$I_O = 1mA$ to $100mA$, $25^\circ C$		25	150	mV
		$I_O = 1mA$ to $40mA$, $25^\circ C$		15	75	
Ripple Rejection	RR	$V_I = 18.5V$ to $28.5V$, $f=120Hz$	34	39		dB
Output Noise Voltage	V_N	$F= 10Hz$ to $100Hz$ $T_J = 25^\circ C$		82		μV
Dropout Voltage	V_D	$T_J = 25^\circ C$		1.7		V
Quiescent Current		$T_J = 25^\circ C$		4.6	6.5mA	mA
Quiescent Current Change	ΔI_Q	$V_I = 19V$ to $30V$, $T_J = 25^\circ C$			1.5	mA
		$I_O = 1mA$ to $40mA$, $T_J = 25^\circ C$			0.1	

Electrical Characteristics (LM78L18)

($V_I=10V$, $I_O=40mA$, $0^\circ C \leq T_J \leq 125^\circ C$, $C_1 = 0.33\mu F$, $C_O = 0.1\mu F$, unless otherwise specified. (Note 1))

Parameter	Symbol	Conditions	MIN	TYP	MAX	UNIT
Output Voltage	V_O	$T_J = 25^\circ C$	17.30	18	18.7	V
Line Regulation	ΔV_O	$V_I = 20.5V$ to $33V$ $T_J = 25^\circ C$		70	360	mV
		$V_I = 20.5V$ to $33V$ $T_J = 25^\circ C$		64	300	
Load Regulation	ΔV_O	$I_O = 1mA$ to $100mA$, $25^\circ C$		27	180	mV
		$I_O = 1mA$ to $40mA$, $25^\circ C$		19	90	
Ripple Rejection	RR	$V_I = 21.5V$ to $31.5V$, $f=120Hz$	32	36		dB
Output Noise Voltage	V_N	$F= 10Hz$ to $100Hz$ $T_J = 25^\circ C$		89		μV
Dropout Voltage	V_D	$T_J = 25^\circ C$		1.7		V
Quiescent Current		$T_J = 25^\circ C$		4.7	6.5mA	mA
Quiescent Current Change	ΔI_Q	$V_I = 22V$ to $33V$, $T_J = 25^\circ C$			1.5	mA
		$I_O = 1mA$ to $40mA$, $T_J = 25^\circ C$			0.1	

Electrical Characteristics (LM78L24)

($V_I=10V$, $I_O=40mA$, $0^\circ C \leq T_J \leq 125^\circ C$, $C_I = 0.33\mu F$, $C_O = 0.1\mu F$, unless otherwise specified. (Note 1))

Parameter	Symbol	Conditions	MIN	TYP	MAX	UNIT
Output Voltage	V_O	$T_J = 25^\circ C$	23	24	25	V
Line Regulation	ΔV_O	$V_I = 26.5V$ to $39V$ $T_J = 25^\circ C$		95	480	mV
		$V_I = 26.5V$ to $39V$ $T_J = 25^\circ C$		78	400	
Load Regulation	ΔV_O	$I_O = 1mA$ to $100mA$, $25^\circ C$		41	240	mV
		$I_O = 1mA$ to $40mA$, $25^\circ C$		28	120	
Ripple Rejection	RR	$V_I = 27.5V$ to $37.5V$, $f=120Hz$	30	33		dB
Output Noise Voltage	V_N	$F=10Hz$ to $100Hz$ $T_J = 25^\circ C$		97		μV
Dropout Voltage	V_D	$T_J = 25^\circ C$		1.7		V
Quiescent Current		$T_J = 25^\circ C$		4.8	6.5mA	mA
Quiescent Current Change	ΔI_Q	$V_I = 28V$ to $39V$, $T_J = 25^\circ C$			1.5	mA
		$I_O = 1mA$ to $40mA$, $T_J = 25^\circ C$			0.1	

Block Diagram

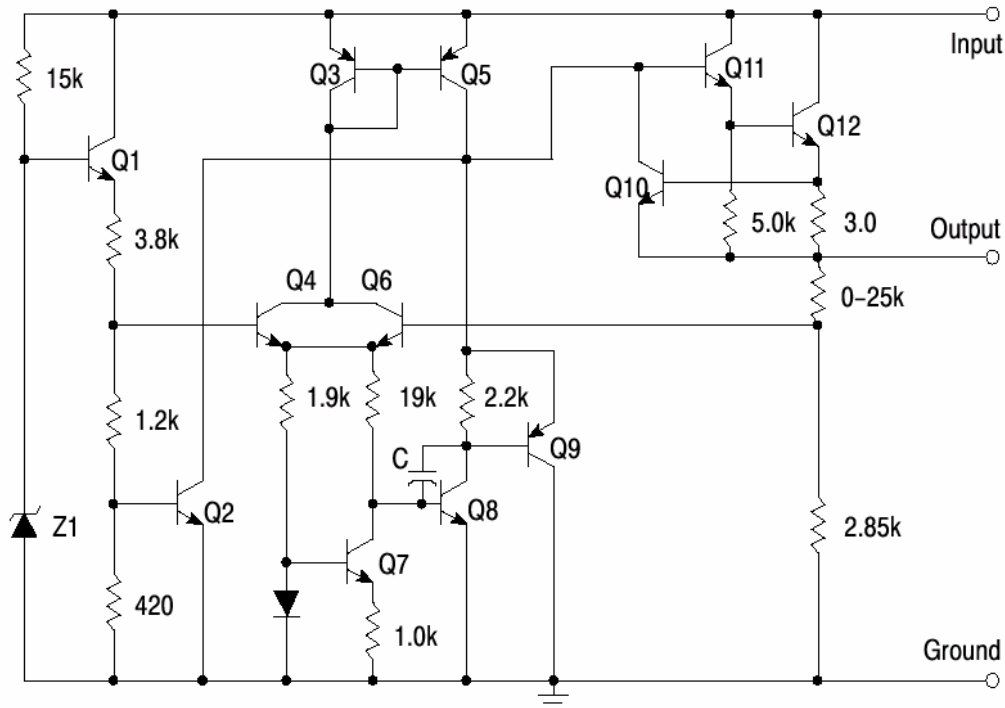

Dropout Characteristics

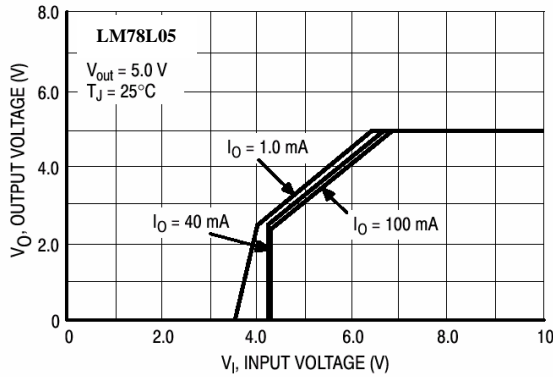

Dropout Voltage vs. Junction Temperature

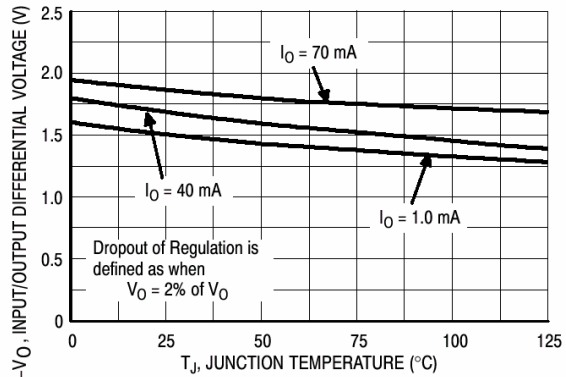

Input Bias Current vs. Ambient Temperature

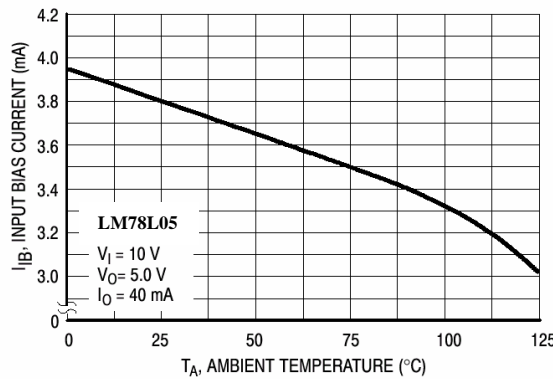

Input Bias Current versus Input Voltage

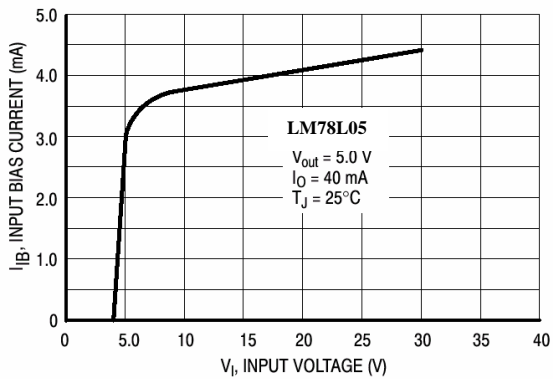

Maximum Average Power Dissipation vs. Ambient Temperature - TO- 92 Type Package

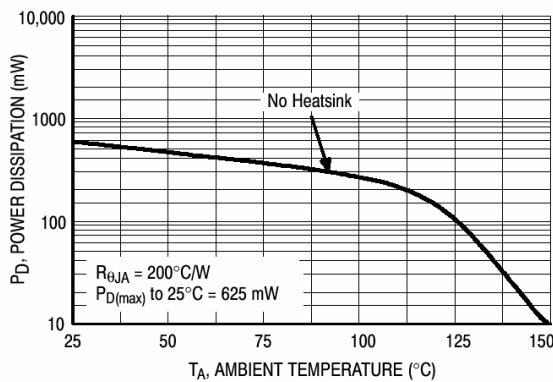

SOP- 8 Thermal Resistance and Maximum Power Dissipation versus P. C. B. Copper Length

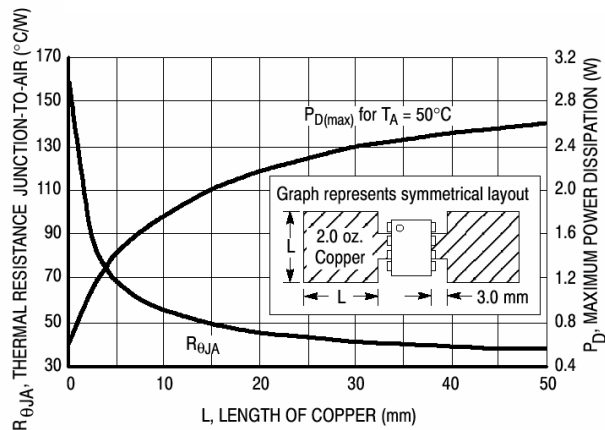

Advance Information- These data sheets contain descriptions of products that are in development. The specifications are based on the engineering calculations, computer simulations and/ or initial prototype evaluation.

Preliminary Information- These data sheets contain minimum and maximum specifications that are based on the initial device characterizations. These limits are subject to change upon the completion of the full characterization over the specified temperature and supply voltage ranges.

The application circuit examples are only to explain the representative applications of the devices and are not intended to guarantee any circuit design or permit any industrial property right to other rights to execute. Bay Linear takes no responsibility for any problems related to any industrial property right resulting from the use of the contents shown in the data book. Typical parameters can and do vary in different applications. Customer's technical experts must validate all operating parameters including "Typical" for each customer application.

LIFE SUPPORT AND NUCLEAR POLICY

Bay Linear products are not authorized for and should not be used within life support systems which are intended for surgical implants into the body to support or sustain life, in aircraft, space equipment, submarine, or nuclear facility applications without the specific written consent of Bay Linear President.
