

Zener diode

LEDZ*BT1G SERIES

●Applications

Constant voltage control

●Features

- 1) 2-pin ultra mini-mold type for high-density mounting .
- 2) High reliability.
- 3) Can be mounted automatically, using chip mounter.



SOD-523

●Construction

Silicon epitaxial planar

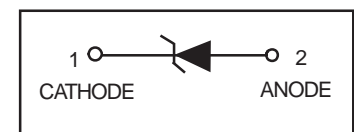

●Pb-Free package is available

ORDERING INFORMATION

Device	Package	Shipping
LEDZ*BT1G	SOD-523	3000/Tape&Reel
LEDZ*BT3G	SOD-523	10000/Tape&Reel

●Absolute maximum ratings

Parameter	Symbol	Limits	Unit
Power dissipation	P	150	mW
Junction temperature	T _j	150	°C
Storage temperature	T _{stg}	-55 to +150	°C
Operating temperature	T _{opr}	-55 to +150	°C

●Type No.

TYPE	TYPE NO.	TYPE	TYPE NO.
LEDZ2.4BT1G	22	LEDZ10BT1G	05
LEDZ2.7BT1G	32	LEDZ11BT1G	15
LEDZ3.0BT1G	42	LEDZ12BT1G	25
LEDZ3.3BT1G	52	LEDZ13BT1G	35
LEDZ3.6BT1G	62	LEDZ15BT1G	45
LEDZ3.9BT1G	72	LEDZ16BT1G	55
LEDZ4.3BT1G	82	LEDZ18BT1G	65
LEDZ4.7BT1G	92	LEDZ20BT1G	75
LEDZ5.1BT1G	A2	LEDZ22BT1G	85
LEDZ5.6BT1G	C2	LEDZ24BT1G	95
LEDZ6.2BT1G	E2	LEDZ27BT1G	A5
LEDZ6.8BT1G	F2	LEDZ30BT1G	C5
LEDZ7.5BT1G	H2	LEDZ33BT1G	E5
LEDZ8.2BT1G	J2	LEDZ36BT1G	F5
LEDZ9.1BT1G	L2		

LEDZ*BT1G SERIES

Electrical characteristics (Ta=25°C)

TYP.	Symbol								
	Zener voltage : Vz(V)			Operating resistance : Zz(Ω)		Rising operating resistance : Zz(Ω)		Reverse current : IR(μA)	
	MIN.	MAX.	Iz(mA)	MAX.	Iz(mA)	MAX.	Iz(mA)	MAX.	VR(V)
LEDZ2.4BT1G	2.43	2.63	5.0	100	5.0	1000.0	0.5	100	1.0
LEDZ2.7BT1G	2.69	2.91	5.0	110	5.0	1000.0	0.5	100	1.0
LEDZ3.0BT1G	3.01	3.22	5.0	120	5.0	1000.0	0.5	50	1.0
LEDZ4.7BT1G	3.32	3.53	5.0	120	5.0	1000.0	0.5	20	1.0
LEDZ3.6BT1G	3.600	3.845	5.0	100	5.0	1000.0	1.0	10.0	1.0
LEDZ3.9BT1G	3.890	4.160	5.0	100	5.0	1000.0	1.0	5.0	1.0
LEDZ4.3BT1G	4.170	4.430	5.0	100	5.0	1000.0	1.0	5.0	1.0
LEDZ4.7BT1G	4.550	4.750	5.0	100	5.0	800.0	0.5	2.0	1.0
LEDZ5.1BT1G	4.980	5.200	5.0	80	5.0	500.0	0.5	2.0	1.5
LEDZ5.6BT1G	5.490	5.730	5.0	60	5.0	200.0	0.5	1.0	2.5
LEDZ6.2BT1G	6.060	6.330	5.0	60	5.0	100.0	0.5	1.0	3.0
LEDZ6.8BT1G	6.650	6.930	5.0	40	5.0	60.0	0.5	0.5	3.5
LEDZ7.5BT1G	7.280	7.600	5.0	30	5.0	60.0	0.5	0.5	4.0
LEDZ8.2BT1G	8.020	8.360	5.0	30	5.0	60.0	0.5	0.5	5.0
LEDZ9.1BT1G	8.850	9.230	5.0	30	5.0	60.0	0.5	0.5	6.0
LEDZ10BT1G	9.770	10.210	5.0	30	5.0	60.0	0.5	0.1	7.0
LEDZ11BT1G	10.760	11.220	5.0	30	5.0	60.0	0.5	0.1	8.0
LEDZ12BT1G	11.740	12.240	5.0	30	5.0	80.0	0.5	0.1	9.0
LEDZ13BT1G	12.910	13.490	5.0	37	5.0	80.0	0.5	0.1	10.0
LEDZ15BT1G	14.340	14.980	5.0	42	5.0	80.0	0.5	0.1	11.0
LEDZ16BT1G	15.850	16.510	5.0	50	5.0	80.0	0.5	0.1	12.0
LEDZ18BT1G	17.560	18.350	5.0	65	5.0	80.0	0.5	0.1	13.0
LEDZ20BT1G	19.520	20.390	5.0	85	5.0	100.0	0.5	0.1	15.0
LEDZ22BT1G	21.540	22.470	5.0	100	5.0	100.0	0.5	0.1	17.0
LEDZ24BT1G	23.720	24.780	5.0	120	5.0	120.0	0.5	0.1	19.0
LEDZ27BT1G	26.190	27.530	2.0	150	2.0	150.0	0.5	0.1	21.0
LEDZ30BT1G	29.190	30.690	2.0	200	2.0	200.0	0.5	0.1	23.0
LEDZ33BT1G	32.150	33.790	2.0	250	2.0	250.0	0.5	0.1	25.0
LEDZ36BT1G	35.070	36.870	2.0	300	2.0	300.0	0.5	0.1	27.0

LEDZ*BT1G SERIES

●Electrical characteristic curves (Ta=25°C)

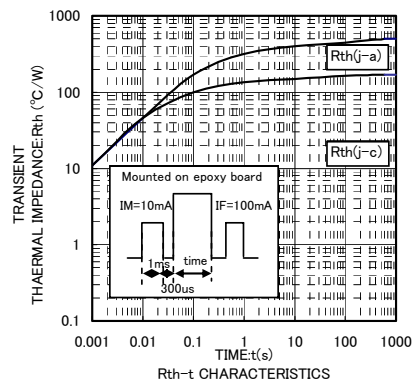
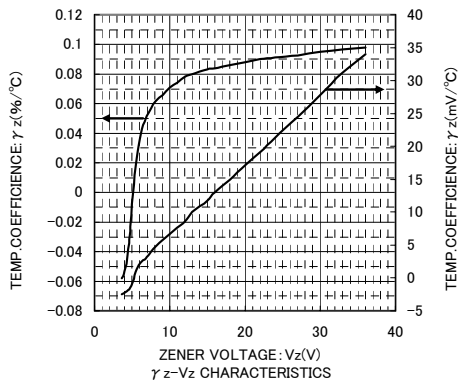
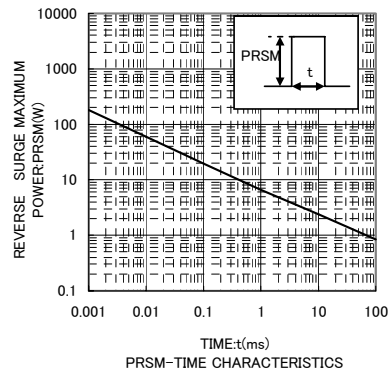
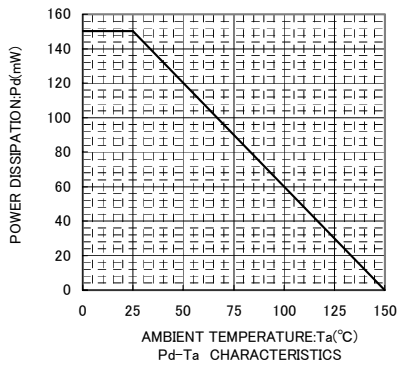
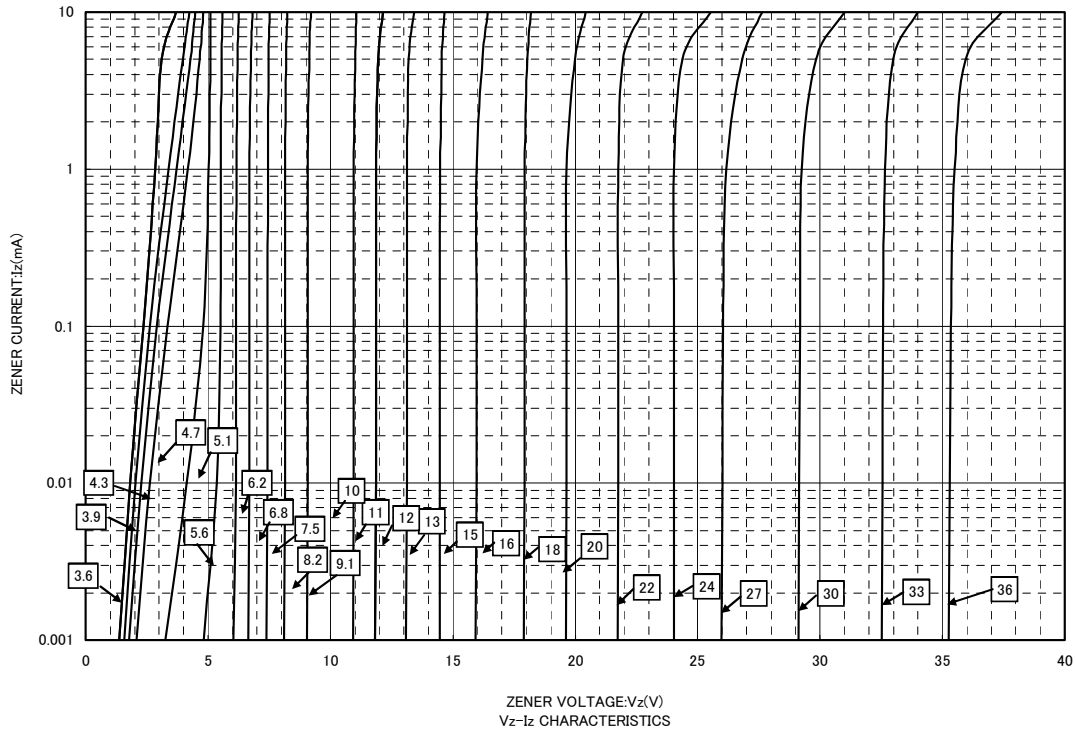

LEDZ*BT1G SERIES

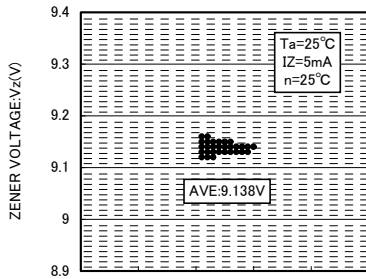
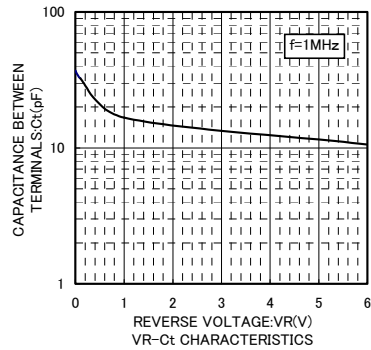
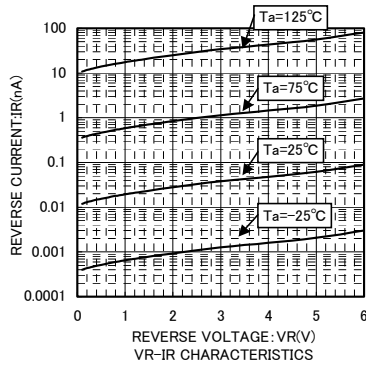
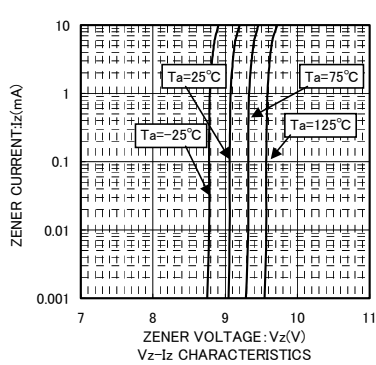

V_z DISPERSION MAP

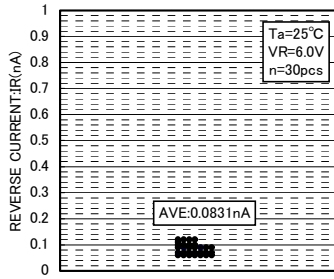

I_R DISPERSION MAP

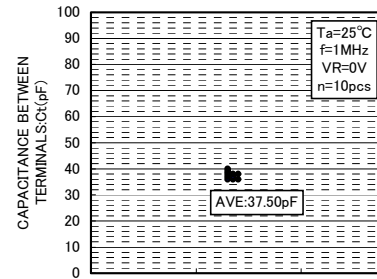

C_t DISPERSION MAP

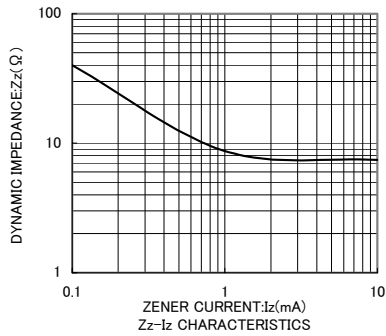

LEDZ*BT1G SERIES

SC-79/SOD-523

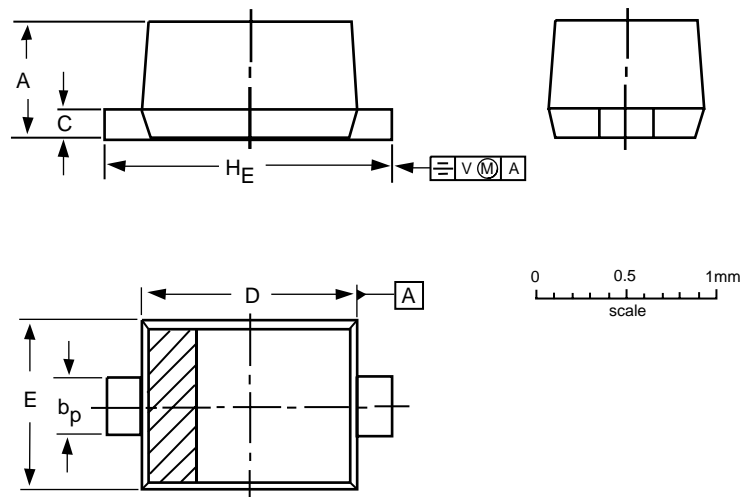

DIMENSIONS (mm are the original dimensions)

UNIT	A	b _p	c	D	E	H _E	V
mm	0.7	0.35	0.2	1.3	0.9	1.7	0.15
	0.5	0.25	0.1	1.1	0.7	1.5	

Note

- The marking bar indicates the cathode.

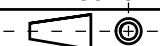
OUTLINE VERSION	REFERENCES			EUROPEAN PROJECTION	ISSUE DATE
	IEC	JEDEC	EIAJ		
SOD523			SC-79		98-11-25