

**HEC100 Dual Models are OBSOLETE PRODUCTS
Last time buy: 1 November 2014**

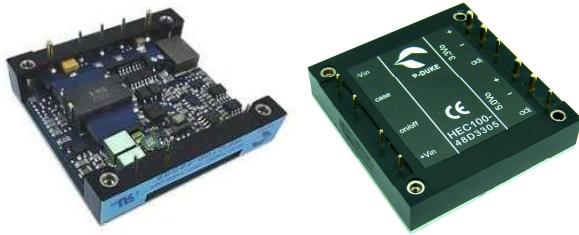

Single

Dual

APPLICATIONS

Wireless Network
Telecom/Datacom
Industry Control System
Distributed Power Architectures
Semiconductor Equipment

FEATURES

- 100 WATTS MAXIMUM OUTPUT POWER
- SINGLE: OUTPUT CURRENT UP TO 25A
DUAL: TOTAL OUTPUT POWER UP TO 100W
- COMPACT 2.40 X 2.28 X 0.50 INCH PACKAGE
- HIGH EFFICIENCY UP TO 90%
- INPUT RANGE FROM 36VDC TO 75VDC
- FIXED SWITCHING FREQUENCY(300kHz)
- HALT TESTED
- INDUSTRY STANDARD FOOTPRINT
- ADJUSTABLE OUTPUT VOLTAGE
- INPUT TO OUTPUT BASIC INSULATION: 1600 VDC
- UL60950-1, EN60950-1, & IEC60950-1 SAFETY APPROVALS
- CE MARKED
- COMPLIANT TO RoHS II & REACH

OPTIONS

Positive and Negative remote on/off, pin length

DESCRIPTION

HEC100-SERIES DC/DC converters provide up to 100 watts of output power in an industry standard half-brick package and footprint. All models feature a wide input range, adjustable output voltage and a 25A current rating.

TECHNICAL SPECIFICATION

All specifications are typical at nominal input, full load and 25°C otherwise noted

OUTPUT SPECIFICATIONS

Output power	Total output power	100 Watts, max.
Voltage accuracy	Single	± 1.5%
	Dual	± 1.0%
Minimum load		0%
Voltage adjustability	Single (Note 5)	+ 10% , -20%
	Dual for Each output	± 10%
Line regulation	LL to HL at FL	See table
Load regulation	Single(No Load to Full Load)	See table
	Dual(No Load to Full Load) Dual for each output	
Remote sense (Note 5)	Single	10% of Vout(nom)
Ripple and noise	20MHz bandwidth (Note 6)	100mVp-p
Temperature coefficient		±0.02% / °C, max.
Transient response recovery time	25% load step change	200µs
Over voltage protection threshold	Single (Hiccup)	115% ~ 130% of Vout(nom)
	Dual	
	2.5VDC	3.0VDC
	3.3VDC	3.9VDC
Over current protection threshold	Single	110% ~ 140% of Iout Rated
	Dual	110% ~ 120% of Iout Rated
Short circuit protection		Continuous, automatic recovery

GENERAL SPECIFICATIONS

Efficiency		See table
Isolation voltage	Input to Output	1600 VDC, min. 1minute
	Input(Output) to Case	1000 VDC, min. 1minute
Isolation resistance	Single	10 ⁷ ohms, min.
	Dual	500VDC 10 ⁹ ohms, min.
Isolation capacitance	Single	2500pF, max.
	Dual	1500pF, max.
Switching frequency		300kHz±10%
Safety approvals (Single Output)		IEC60950-1, UL60950-1, & EN60950-1
Case material	Dual	Non-conductive black plastic
Base material		Aluminum base-plate
Potting material	Dual	Silicone (UL94 V-0)
Weight	Single	65g (2.29oz)
	Dual	105g (3.70oz)
MTBF (Note 1)	MIL-HDBK-217F	4.353 x 10 ⁵ hrs

INPUT SPECIFICATIONS

Input voltage range		36 ~ 75VDC
Input filter		L-C type
Input surge voltage		100VDC 100ms, max.
Start up time	Nominal input and constant resistive load	Single, Dual Power up 25ms Single Remote ON/OFF 25ms
UVLO Start-up voltage	Single	34VDC
	Dual	35VDC
UVLO Shutdown voltage	Single	32VDC
	Dual	33VDC
OVLO start-up voltage	Dual	76.5VDC
OVLO shutdown voltage	Dual	78.5VDC
Input reflected ripple current	Single	20mA p-p
Remote ON/OFF (Note 7)	Single—	
	(Negative logic)	ON=Short or 0V < Vr < 1.2V, I _{IN} =1mA max. OFF=Open or 3V < Vr < 15V, I _{IN} =50µA max.
(Positive logic)		ON=Open or 3V < Vr < 15V, I _{IN} =50µA max. OFF=Short or 0V < Vr < 1.2V, I _{IN} =1mA max.
Dual—	(Positive logic)	ON=Open or 3V < Vr < +Vin OFF=Short or Vr < 1.2V
	(Negative logic)	ON= Short or Vr < 1.2V OFF=Open or 3V < Vr < +Vin
Input current of remote control pin	Nominal input	-0.5mA ~ 0.5mA
Remote off state input current	Nominal input	20mA

ENVIRONMENTAL SPECIFICATIONS

Operating base-plate temperature range (Note 8)		-40°C ~ +100°C
Over temperature protection	Single	110°C
	Dual for base plate	105°C
Humidity max, Non-condensing		95%
Storage temperature range		-55°C ~ +125°C
Thermal shock		MIL-STD-810F
Vibration		MIL-STD-810F

EMC CHARACTERISTICS

EMI (Note 9)	EN55022		Class A, Class B
Radiated immunity	EN61000-4-3	10 V/m	Perf. Criteria A
Fast transient (Note 10)	EN61000-4-4	± 2kV	Perf. Criteria B
Surge (Note 10)	EN61000-4-5	± 1kV	Perf. Criteria B
Conducted immunity	EN61000-4-6	10 Vr.m.s	Perf. Criteria A

Model Number	Input Range	Output Voltage	Output Current		Line Regulation	Load Regulation	No load ⁽³⁾ Input Current	Eff ⁽⁴⁾ (%)
			Min. load	Full load				
HEC100-48S1P8	36 ~ 75 VDC	1.8 VDC	0mA	25 A	4 mV	6 mV	110mA	85
HEC100-48S2P5	36 ~ 75 VDC	2.5 VDC	0mA	25 A	5 mV	8 mV	80mA	87
HEC100-48S3P3	36 ~ 75 VDC	3.3 VDC	0mA	25 A	7 mV	10 mV	100mA	89
HEC100-48S05	36 ~ 75 VDC	5.0 VDC	0mA	20 A	10 mV	15 mV	100mA	90
HEC100-48S15	36 ~ 75 VDC	15 VDC	0mA	6.66 A	30 mV	45 mV	200mA	90

OBSOLETE PRODUCT

Last time buy: 1 November 2014

Model Number	Input Range	Output Voltage		Output Current		Line Regulation		Load Regulation		No load ⁽³⁾ Input Current	Eff ⁽⁴⁾ (%)
		V1	V2	I 1	I 2	V1	V2	V1	V2		
HEC100-48D3305	36 ~ 75 VDC	5 VDC	3.3 VDC	20 A	25 A	25mV	16.5mV	25mV	16.5mV	200mA	88
HEC100-48D2505	36 ~ 75 VDC	5 VDC	2.5 VDC	20 A	25 A	25mV	12.5mV	25mV	12.5mV	200mA	85
HEC100-48D2533	36 ~ 75 VDC	3.3 VDC	2.5 VDC	25 A	25 A	16.5mV	12.5mV	16.5mV	12.5mV	190mA	85

Note

- MIL-HDBK-217F @Tc=70 °C, Full load.
- The converter is provided by basic insulation.
- Typical value at nominal input voltage and no load.
- Typical value at nominal input voltage and full load.
The dual efficiency test condition: HEC100-48D3305 @ 5V/12A and 3.3V/12A
HEC100-48D2505 @ 5V/12A and 2.5V/16A
HEC100-48D2533 @ 3.3V/18A and 2.5V/16A
- Maximum output deviation is 10% inclusive of remote sense. If remote sense is not being used, the +SENSE should be connected to its corresponding +OUTPUT and likewise the -SENSE should be connected to its corresponding -OUTPUT.
- Single : Measured with a 1μF M/C and a 10μF T/C.
Dual : Measured without any external filter.
- The negative / positive logic and pin length (DIM) are optional. The pin voltage is referenced to -INPUT.
Single : Please see single output product options table.
Dual : Please see dual output product options table.
- Heat-sink is optional and P/N: 7G-0021A-F, 7G-0022A-F, 7G-0023A-F, 7G-0024A-F.
- The HEC100 series standard module meets EN55022 Class A and Class B with external components.
For more detail information, please contact with P-DUKE.
- An external input filter capacitor is required if the module has to meet EN61000-4-4, EN61000-4-5.
The filter capacitor Power Mate suggest: Nippon chemi-con KY series, 220μF /100V.
- CASE GROUNDING : When connect the case pin and four screw bolts to shield plane, the EMI could be reduced.

CAUTION: This power module is not internally fused. An input line fuse must always be used.

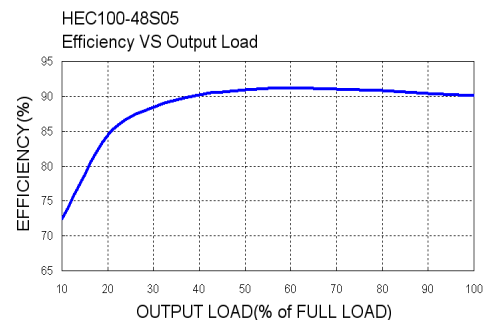
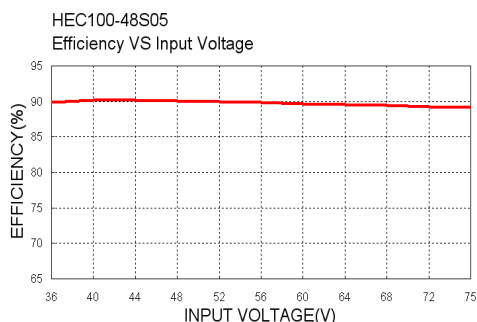
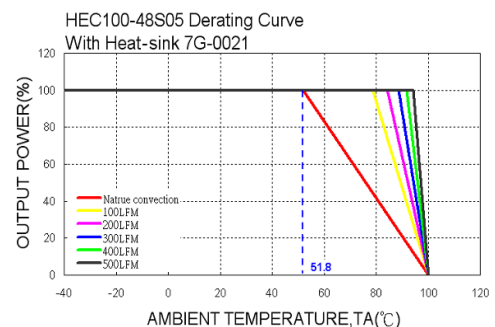
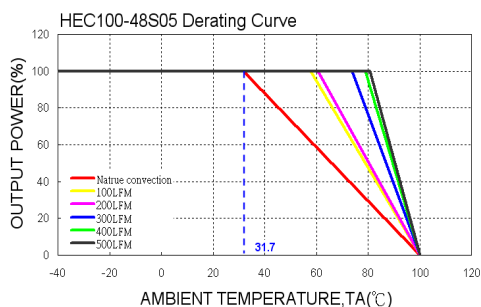

MECHANICAL DRAWING :
SINGLE OUTPUT:

Threaded(Standard) 4-M3X0.5
Trough hole(OPTION) 4- ϕ 0.126(ϕ 3.2)
The screw locked torque:
MAX 3.5Kgf-cm/0.34N-m(Note:11)

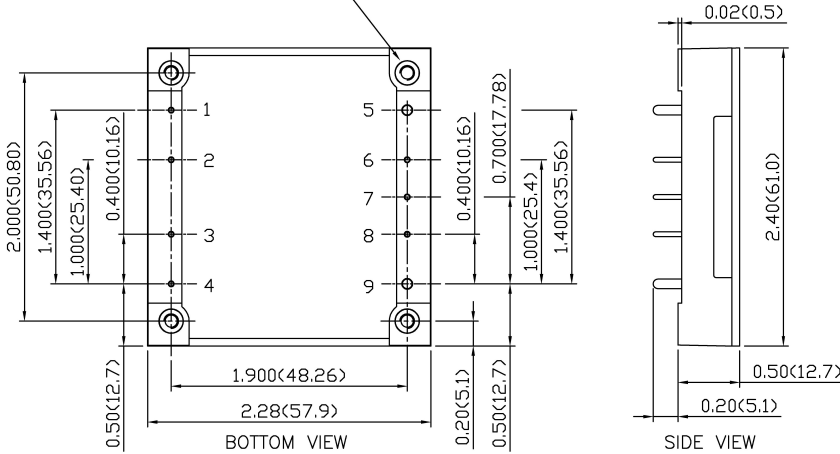

- All dimensions in Inch (mm)
Tolerance: X.XX \pm 0.02 (X.X \pm 0.5)
X.XXX \pm 0.01 (X.XX \pm 0.25)
- Pin pitch tolerance \pm 0.01(0.25)
- Pin dimension tolerance \pm 0.004 (0.1)

Remote On/Off and Pin Options	Suffix
Negative remote ON/OFF logic, 0.20" pin length (standard)	-
Negative remote ON/OFF logic, 0.145" pin length	-L
Positive remote ON/OFF logic, 0.20" pin length	-P
Positive remote ON/OFF logic, 0.145" pin length	-S

Example : HEC100-48S3P3-PHS
* The module can't equip heat-sink with TH option.

PIN CONNECTION		
PIN	DEFINE	DIAMETER
1	-Vin	0.040 Inch (1.02mm)
2	Case	0.040 Inch (1.02mm)
3	Ctrl	0.040 Inch (1.02mm)
4	+Vin	0.040 Inch (1.02mm)
5	-Vout	0.080 Inch (2.03mm)
6	-Sense	0.040 Inch (1.02mm)
7	Trim	0.040 Inch (1.02mm)
8	+Sense	0.040 Inch (1.02mm)
9	+Vout	0.080 Inch (2.03mm)

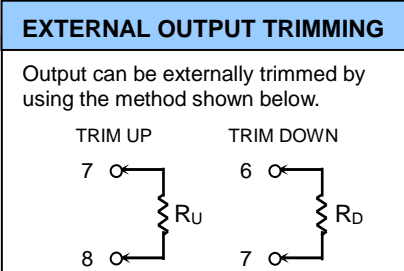

Heat-Sink and Mounting Hole Tread Options	Suffix
Without heat-sink	-
7G-0021A-F	-HS
7G-0022A-F	-HS1
7G-0023A-F	-HS2
7G-0024A-F	-HS3
Through hole (No thread)	-TH

DUAL OUTPUT:

Threaded(Standard) 4-M3X0.5
Trough hole(OPTION) 4- ϕ 0.126(ϕ 3.2)
The screw locked torque:
MAX 3.5Kgf-cm/0.34N-m(Note:11)

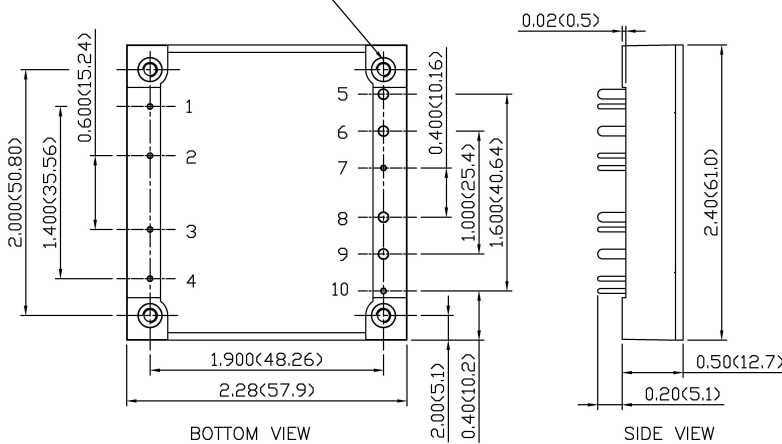

- All dimensions in Inch (mm)
Tolerance: X.XX \pm 0.02 (X.X \pm 0.5)
X.XXX \pm 0.01 (X.XX \pm 0.25)
- Pin pitch tolerance \pm 0.01(0.25)
- Pin dimension tolerance \pm 0.004 (0.1)

Remote On/Off and Pin Options	Suffix
Positive remote ON/OFF logic, PIN 5,6,8,9 DIM 0.08"	-
Positive remote ON/OFF logic, PIN 5,6,8,9 DIM 0.04"	-Y
Negative remote ON/OFF logic, PIN 5,6,8,9 DIM 0.08"	-N
Negative remote ON/OFF logic, PIN 5,6,8,9 DIM 0.04"	-Z

Example : HEC100-48D3305-PHS
* The module can't equip heat-sink with TH option.

PIN CONNECTION		
PIN	DEFINE	DIAMETER
1	-Vin	0.040 Inch (1.02mm)
2	Case	0.040 Inch (1.02mm)
3	Ctrl	0.040 Inch (1.02mm)
4	+Vin	0.040 Inch (1.02mm)
5	+V2	0.080 Inch (2.03mm)
6	-V2 (Com)	0.080 Inch (2.03mm)
7	V2 Trim	0.040 Inch (1.02mm)
8	+V1	0.080 Inch (2.03mm)
9	-V1 (Com)	0.080 Inch (2.03mm)
10	V1 Trim	0.040 Inch (1.02mm)

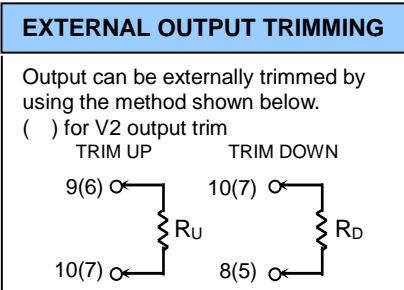

Heat-Sink and Mounting Hole Tread Options	Suffix
Without heat-sink	-
7G-0021A-F	-HS
7G-0022A-F	-HS1
7G-0023A-F	-HS2
7G-0024A-F	-HS3
Through hole (No thread)	-TH