

Applications

- Commercial and Military Radar
- Satellite Communications

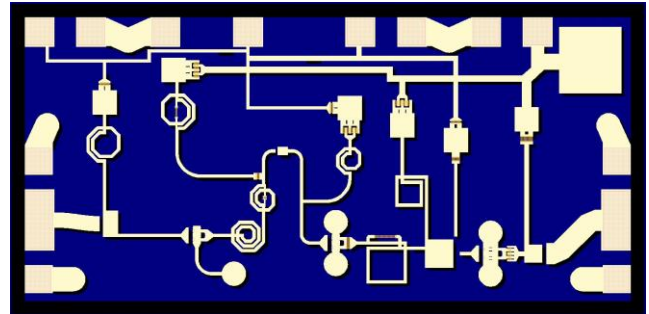

Product Features

- Frequency Range: 16 - 18 GHz
- NF: 2.3 dB
- Small Signal Gain: 28 dB
- Return Loss: >9 dB
- P1dB: 6 dBm
- $P_{SAT} = 10$ dBm at $P_{IN} = -10$ dBm
- OTOI: 13 dBm ($P_{out}/tone = -2$ dBm)
- Bias: $V_D = 3$ V, $I_{DQ} = 30$ mA, $V_G = -0.6$ V
- Chip Dimensions: 2.1 x 1.1 x 0.1 mm

Functional Block Diagram

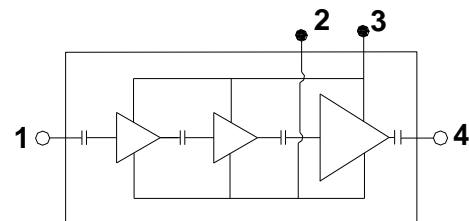

General Description

TriQuint's TGA2618 is a Ku-band Low Noise Amplifier fabricated on TriQuint's TQPHT15 0.15 μ m GaAs pHEMT process. The TGA2618 operates from 16 to 18 GHz and typically provides 6 dBm P1dB, 28 dB of small signal gain and 13 dBm OTOI with 2.3 dB NF.

The TGA2618 is ideally suited to support both radar and satellite communications as either an LNA or a general purpose gain block.

Both RF ports have intergraded DC blocking caps and are fully matched to 50 ohms allowing for simple system integration.

Lead-free and RoHS compliant

Evaluation Boards are available upon request.

Pad Configuration

Pad No.	Symbol
1	RF _{IN}
2	V _G
3	V _D
4	RF _{OUT}

Ordering Information

Part	ECCN	Description
TGA2618	EAR99	16 - 18 GHz GaN LNA

Absolute Maximum Ratings

Parameter	Value
Drain Voltage (V_D)	6 V
Gate Voltage Range (V_G)	-2 to 0 V
Drain Current (I_D)	70 mA
Gate Current (I_G)	-0.5 to 6 mA
Power Dissipation, 85 °C (P_{DISS})	0.3 W
Input Power, CW, 50 Ω , (P_{IN})	0 dBm
Channel temperature (T_{CH})	200 °C
Mounting Temperature (30 Seconds)	320 °C
Storage Temperature	-55 to 150 °C

Operation of this device outside the parameter ranges given above may cause permanent damage. These are stress ratings only, and functional operation of the device at these conditions is not implied.

Recommended Operating Conditions

Parameter	Value
Drain Voltage (V_D)	3 V
Drain Current (I_{DQ})	30 mA
Gate Voltage (V_G)	-0.6 V Typical
Temperature (T_{BASE})	-40 to 85 °C

Electrical specifications are measured at specified test conditions. Specifications are not guaranteed overall operating conditions.

Electrical Specifications

Test conditions unless otherwise noted: 25 °C, $V_D = 3$ V, $I_{DQ} = 30$ mA, $V_G = -0.6$ V, CW

Parameter	Min	Typical	Max	Units
Operational Frequency Range	16		18	GHz
Small Signal Gain		28		dB
Noise Figure		2.3		dB
Input Return Loss		>9		dB
Output Return Loss		>10		dB
Output Power at 1 dB Gain Compression		6		dBm
Output TOI at $P_{out}/tone = -2$ dBm		13		dBm
Gain Temperature Coefficient		-0.03		dB/°C
Noise Figure Temperature Coefficient		0.007		dB/°C

Thermal and Reliability Information

Parameter	Test Conditions	Value	Units
Thermal Resistance (θ_{JC}) ⁽¹⁾	$T_{base} = 85\text{ }^\circ\text{C}$, $V_D = 3\text{ V (CW)}$ $I_{DQ} = 30\text{ mA}$, $P_{DISS} = 0.09\text{ W}$	96	$^\circ\text{C/W}$
Channel Temperature (T_{CH}) (Without RF)		94	$^\circ\text{C}$
Median Lifetime (T_M)		1.3×10^9	Hrs
Thermal Resistance (θ_{JC}) ⁽¹⁾	$T_{base} = 85\text{ }^\circ\text{C}$, $V_D = 3\text{ V (CW)}$ $I_{DQ} = 30\text{ mA}$, $I_{D_Drive} = 50\text{ mA}$ $P_{IN} = -10\text{ dBm}$, $P_{OUT} = 10\text{ dBm}$, $Freq = 17\text{ GHz}$, $P_{DISS} = 0.14\text{ W}$	96	$^\circ\text{C/W}$
Channel Temperature (T_{CH}) (Under RF drive)		98	$^\circ\text{C}$
Median Lifetime (T_M)		7.5×10^8	Hrs

Notes:

1. Thermal resistance calculated at back of a 40 mil CuMo carrier plate with 1.5 mil of AuSn solder for die attach.

Test Conditions: $V_D = 6\text{ V}$; Failure Criteria is 10% reduction in I_{D_MAX}

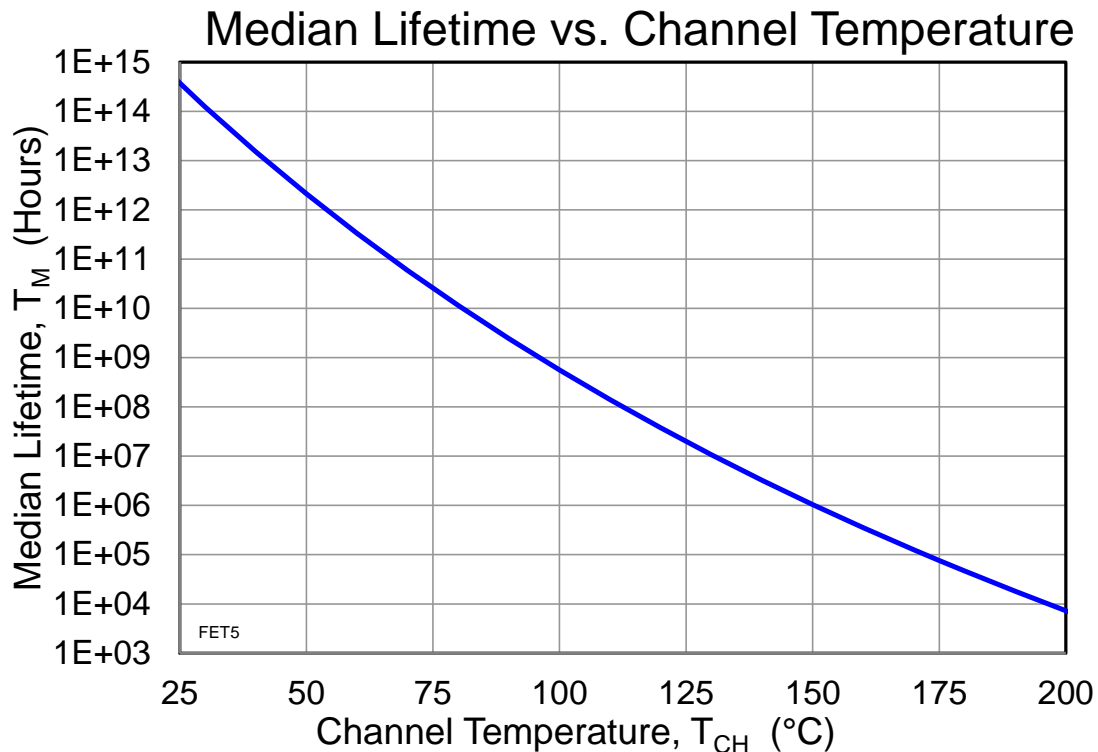

Typical Performance: Small Signal

Conditions unless otherwise specified: $V_D = 3\text{ V}$, $I_{DQ} = 30\text{ mA}$, $V_G = -0.6\text{ V}$, CW

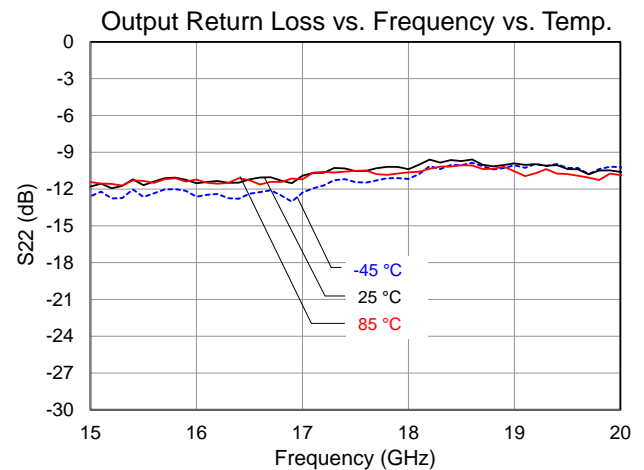
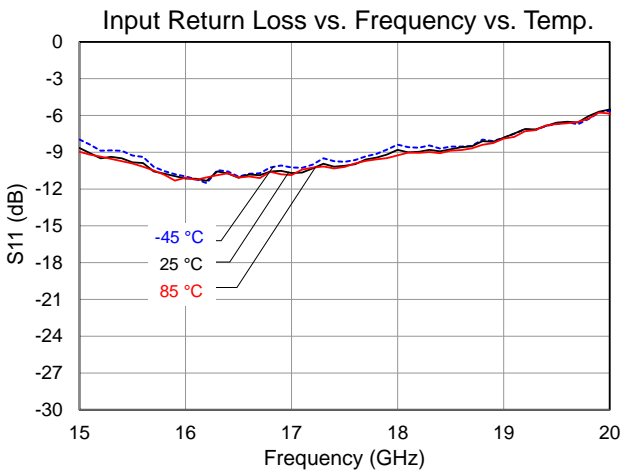
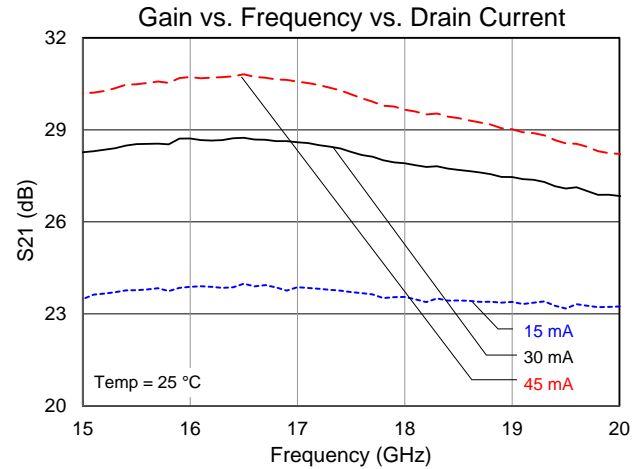
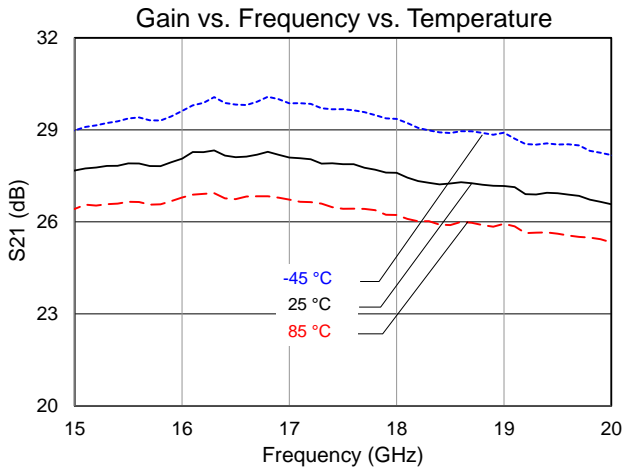
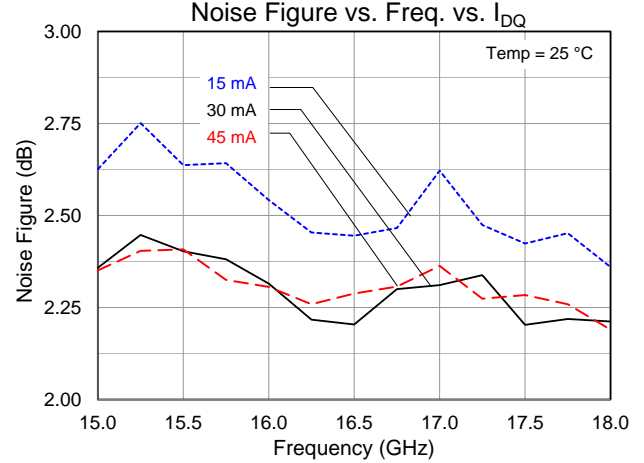
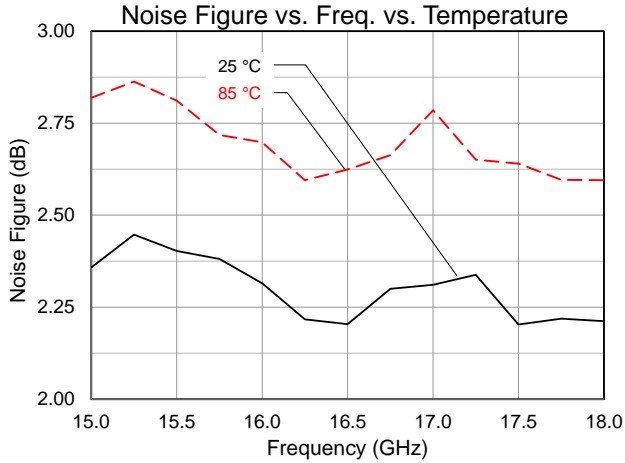

Typical Performance: Linearity

Conditions unless otherwise specified: $V_D = 3\text{ V}$, $I_{DQ} = 30\text{ mA}$, $V_G = -0.6\text{ V}$, CW

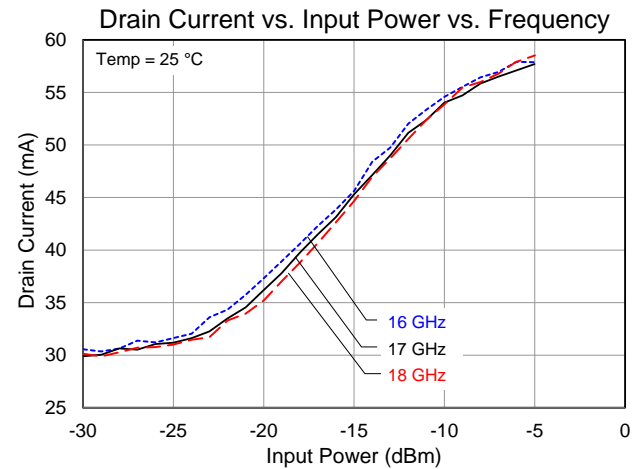
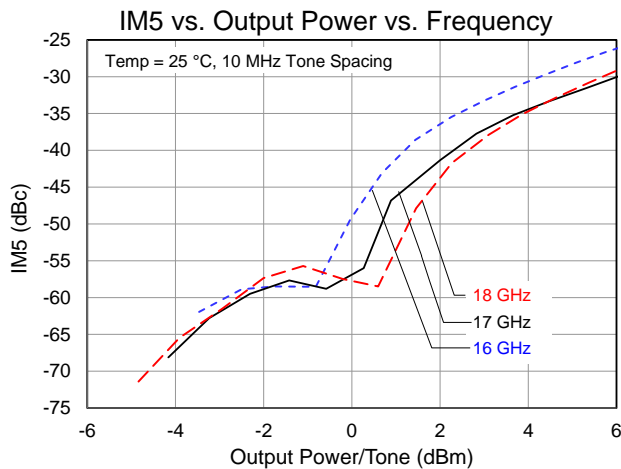
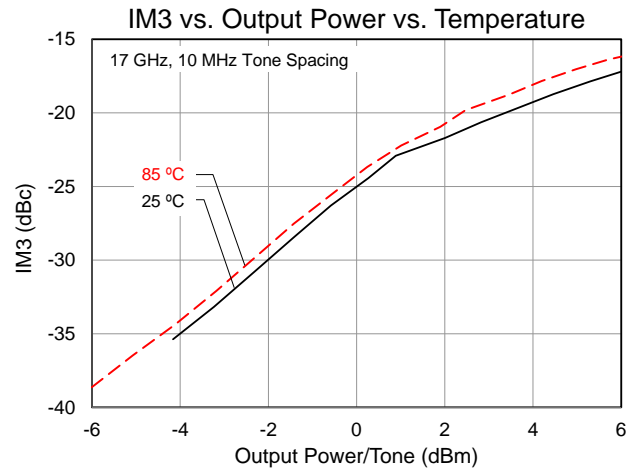
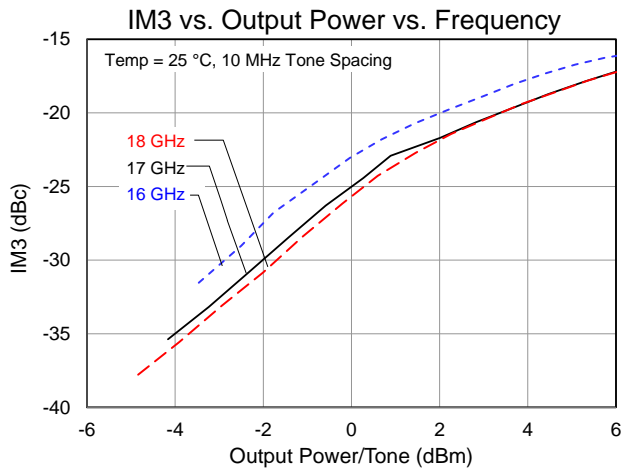
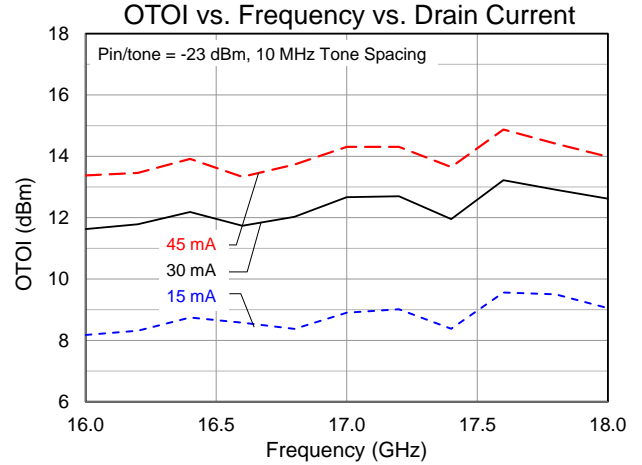
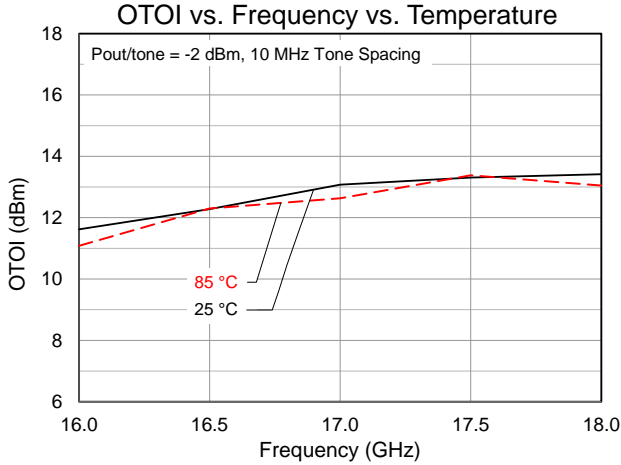

Typical Performance: Large Signal

Conditions unless otherwise specified: $V_D = 3\text{ V}$, $I_{DQ} = 30\text{ mA}$, $V_G = -0.6\text{ V}$, CW

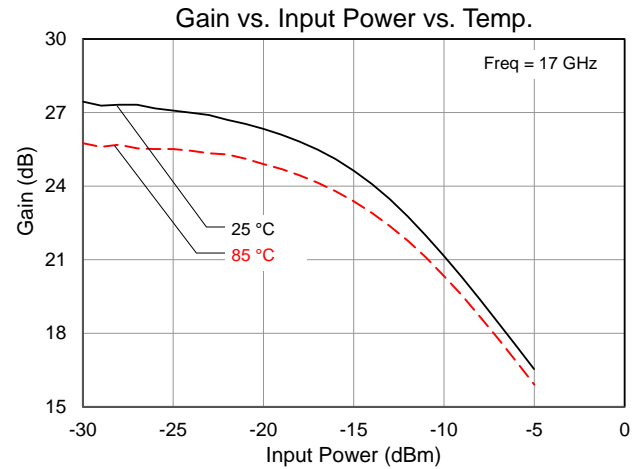
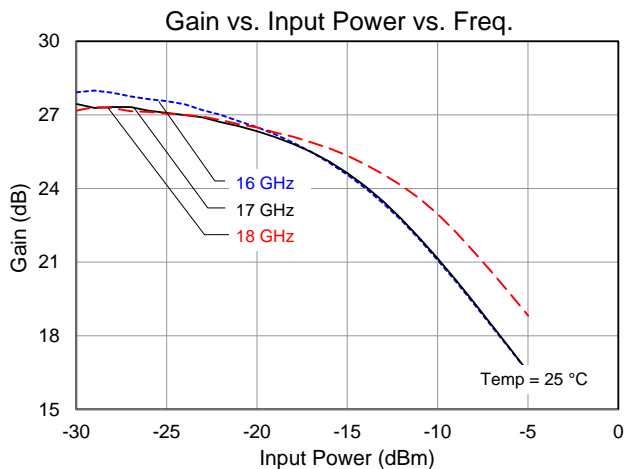
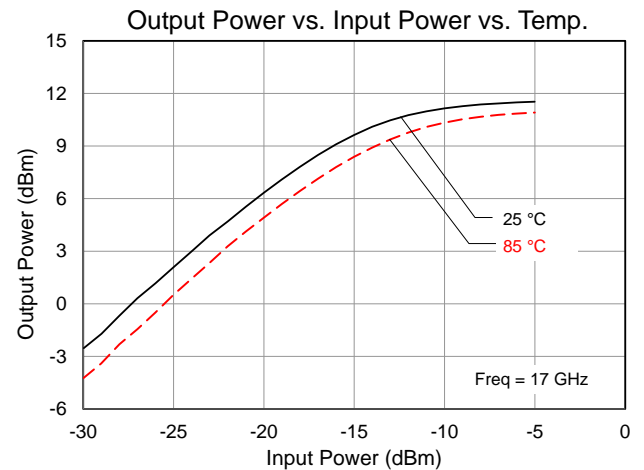
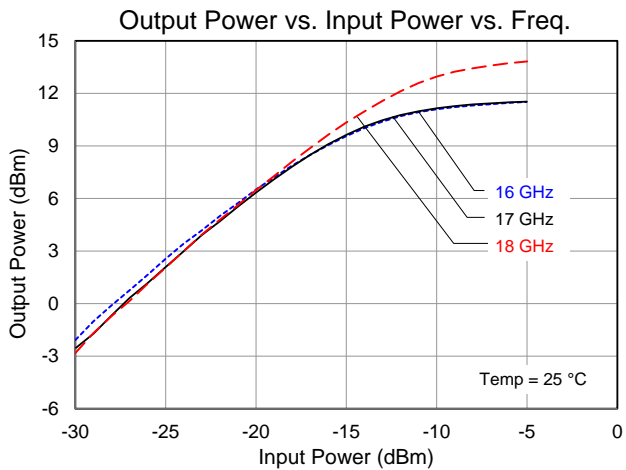
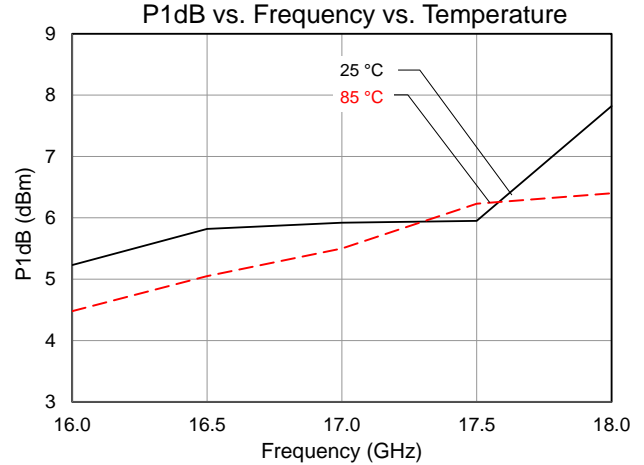
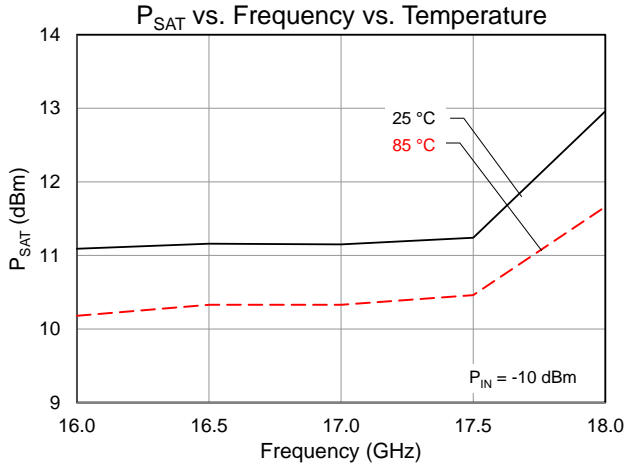

Application Information

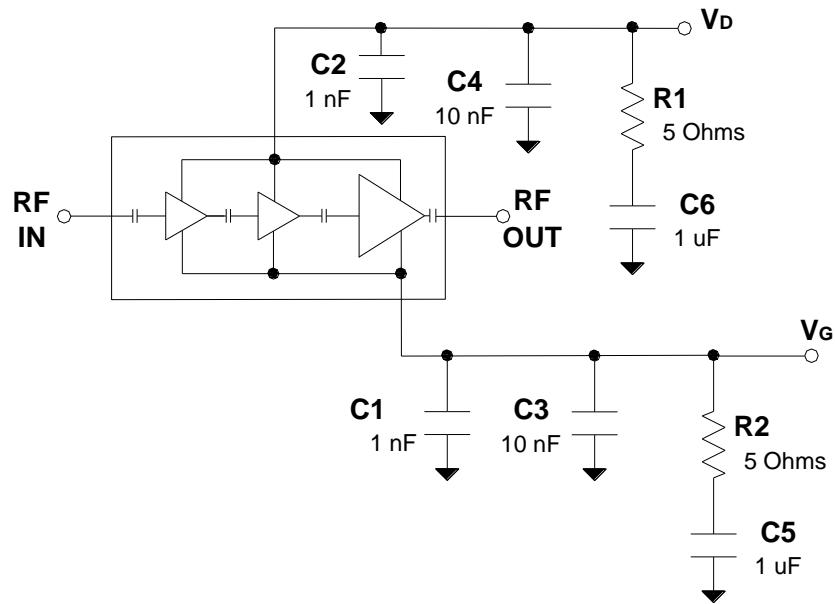

Bias-up Procedure

1. Set I_D limit to 70 mA, I_G limit to 6 mA
2. Apply -2 V to V_G for pinch off
3. Apply +3 V to V_D
4. Adjust V_G more positive until $I_{DQ} = 30$ mA ($V_G \sim -0.6$ V Typical)
5. Apply RF signal

Bias-down Procedure

1. Turn off RF signal
2. Reduce V_G to -2V. Ensure $I_{DQ} \sim 0$ mA
3. Set V_D to 0V
4. Turn off V_D supply
5. Turn off V_G supply

Assembly Drawing

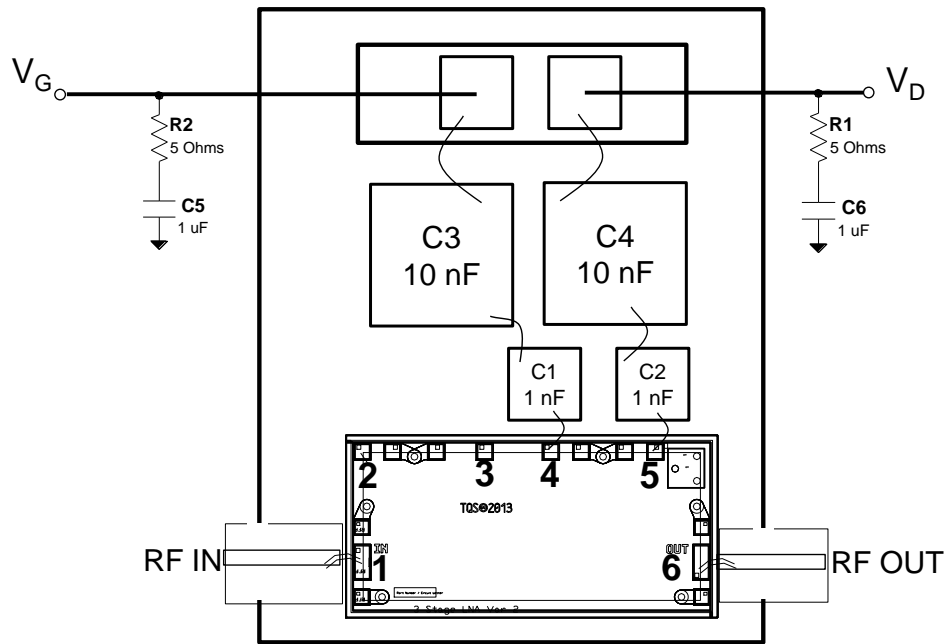

Bill of Material

Reference Des.	Value	Description	Manuf.	Part Number
C1, C2	1 nF	Single-layer ceramic capacitor	Various	
C3, C4	10 nF	Single or multi-layer ceramic capacitor (may also use 0.01 μF SMT capacitors)	Various	
C5, C6	1 μF	1206 SMT Capacitor	Various	
R1, R2	5 Ohms	SMT Resistor	Various	

Mechanical Information

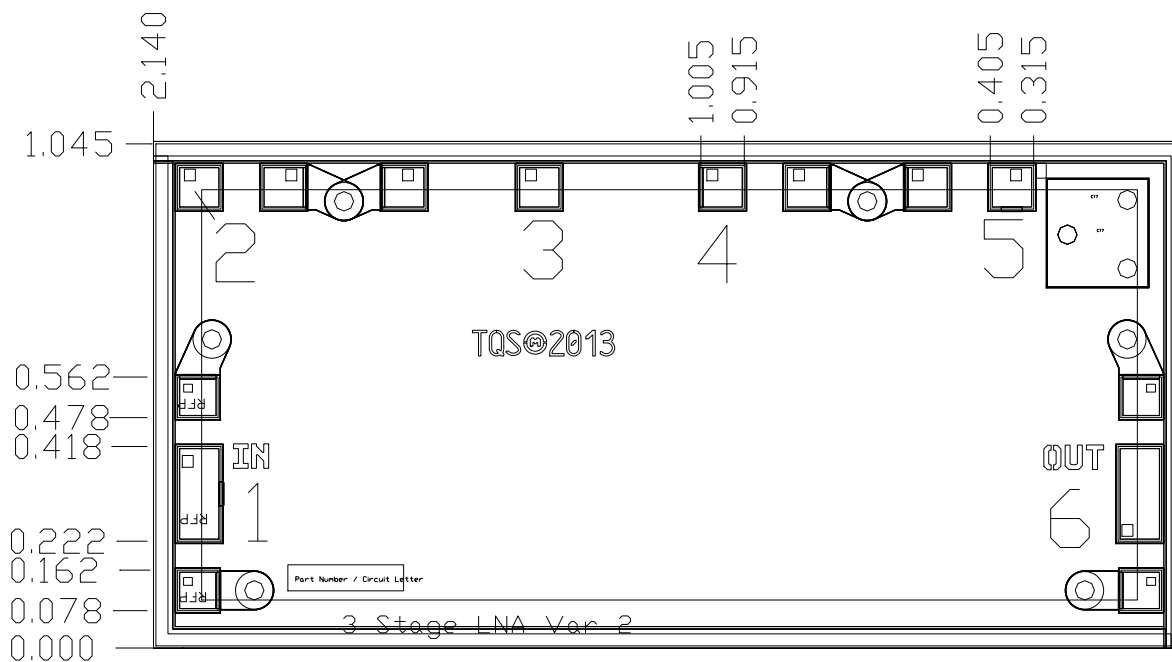

Units: millimeters
 Thickness: 0.10
 Die x,y size tolerance: ± 0.050
 Ground is backside of die
 RF_{IN} and RF_{OUT} pads are symmetric

Pad Description

Pad No.	Symbol	Description	Pad Size
1	RF _{IN}	Input; matched to 50 Ω ; DC blocked	0.205 x 0.1 mm
2,3	N/C	Do not connect	0.1 x 0.1 mm
4	V _G	Gate voltage; bias network is required; see recommended Application	0.1 x 0.1 mm
5	V _D	Drain voltage; bias network is required; see recommended Application	0.1 x 0.1 mm
6	RF _{OUT}	Output; matched to 50 Ω ; DC blocked	0.205 x 0.1 mm

Assembly Notes

Component placement and adhesive attachment assembly notes:

- Vacuum pencils and/or vacuum collets are the preferred method of pick up.
- Air bridges must be avoided during placement.
- The force impact is critical during auto placement.
- Organic attachment (i.e. epoxy) can be used in low-power applications.
- Curing should be done in a convection oven; proper exhaust is a safety concern.

Solder attachment reflow process assembly notes:

- Use AuSn (80/20) solder and limit exposure to temperatures above 300°C to 3 to 4 minutes, maximum.
- An alloy station or conveyor furnace with reducing atmosphere should be used.
- Do not use any kind of flux.
- Coefficient of thermal expansion matching is critical for long-term reliability.
- Devices must be stored in a dry nitrogen atmosphere.

Organic adhesive attachment assembly notes:

- Organic adhesives such as ABLEBOND 84-1, or equivalent, can be used.
- Epoxies cure at temperatures of 100 to 200°C.

Interconnect process assembly notes:

- Thermosonic ball bonding is the preferred interconnect technique.
- Force, time, and ultrasonics are critical parameters.
- Aluminum wire should not be used.
- Devices with small pad sizes should be bonded with 0.0007-inch wire.

Product Compliance Information

ESD Sensitivity Ratings



Caution! ESD-Sensitive Device

ESD Rating: TBD
Value: TBD
Test: Human Body Model (HBM)
Standard: JEDEC Standard JESD22-A114

MSL Rating

Level TBD at TBD°C convection reflow
The part is rated Moisture Sensitivity Level TBD at TBD°C
per JEDEC standard IPC/JEDEC J-STD-020.

ECCN

US Department of Commerce: EAR99

RoHS-Compliance

This part is compliant with EU 2002/95/EC RoHS directive (Restrictions on the Use of Certain Hazardous Substances in Electrical and Electronic Equipment).

This product also has the following attributes:

- Lead Free
- Halogen Free (Chlorine, Bromine)
- Antimony Free
- TBBP-A (C₁₅H₁₂Br₄O₂) Free
- PFOS Free
- SVHC Free

Contact Information

For the latest specifications, additional product information, worldwide sales and distribution locations, and information about TriQuint:

Web: www.triquint.com
Email: info-sales@triquint.com

Tel: +1.972.994.8465
Fax: +1.972.994.8504

For technical questions and application information: Email: info-products@triquint.com

Important Notice

The information contained herein is believed to be reliable. TriQuint makes no warranties regarding the information contained herein. TriQuint assumes no responsibility or liability whatsoever for any of the information contained herein. TriQuint assumes no responsibility or liability whatsoever for the use of the information contained herein. The information contained herein is provided "AS IS, WHERE IS" and with all faults, and the entire risk associated with such information is entirely with the user. All information contained herein is subject to change without notice. Customers should obtain and verify the latest relevant information before placing orders for TriQuint products. The information contained herein or any use of such information does not grant, explicitly or implicitly, to any party any patent rights, licenses, or any other intellectual property rights, whether with regard to such information itself or anything described by such information.

TriQuint products are not warranted or authorized for use as critical components in medical, life-saving, or life-sustaining applications, or other applications where a failure would reasonably be expected to cause severe personal injury or death.