



NAN YA PLASTICS CORPORATION

SPECIFICATION OF
LCD MODULE
PRODUCT NO. : LVCC9Z803YS_

SPEC. NO. : LM803-0-0

CUSTOMER
APPROVED BY
DATE:

EDITED ON : Jan. 29, 2008

LCD DEPARTMENT
ELECTRONIC MATERIALS DIVISION
NAN YA PLASTICS CORPORATION
201, TUNG HWA N. ROAD, TAIPEI
TEL:886-2-27122211 EXT. 5993~5995
FAX:886-2-27178253
E-mail:lcdsales@npc.com.tw

Q.C. DEPT.	DESIGN MANAGER	DESIGN CHECK	DESIGNER
			C.Y.CHAN

NAN YA PLASTICS CORP. ELEC. MATERIALS DIV. LCD DEPARTMENT	SPECIFICATION	SPEC. NO. : LM803-0 DATE : JAN. 29, 2008 SHEET NO. : 1
---	---------------	--

1.MECHANICAL DATA

NO.	ITEM	CONTENTS	UNIT
1	Product No.	LVCC9Z803YS_	—
2	Module Size	125.00 (W) x 98.80 (H) x Max. 7.50(D) Without FPC	mm
3	Pixel Size	0.18 (W) x 0.18 (H)	mm
4	Active Area	115.20 (W) x 86.40 (H)	mm
5	Number of Dots	640 RGB (W) x 480 (H)	Dot
6	LCD Display Mode	TFT 5.7' , Normally White / Positive Image	—
7	Rear Polarizer	Color Transmissive Type	—
8	Viewing Direction	12	O'clock
9	Backlight	LED	—
10	Driver IC	Source:HX8250-A01B(COG) ; Gate:HX8678-A000(COG)	—
11	DC/DC Converter	Excluded	—
12	Touch Panel	Excluded	—
13	Weight	125 (Approx.)	g

NOTE:

L V C C 9 Z 8 0 3 Y S
(1) (2) (3) (4)

NO.	ITEM	SYMBOL	DEFINITION
(1)	Backlight	C	LED Backlight
(2)	Reflective/Transmissive	Z	Transmissive
(3)	Mode/View Angle	Y	Color Module, 12 O'clock
(4)	Option	S	RoHS Compliance

RoHS Compliance.

Nan Ya guarantees that this project doesn't include any materials (6 materials) or includes less than specified quantities which are regulated by RoHS Compliance.

REV/DATE	R0/ 01.29.08'						BY C.Y.CHAN
----------	------------------	--	--	--	--	--	----------------

NAN YA PLASTICS CORP. ELEC. MATERIALS DIV. LCD DEPARTMENT	SPECIFICATION	SPEC. NO. : LM803-0 DATE : JAN. 29, 2008 SHEET NO. : 2
---	---------------	--

2.ABSOLUTE MAXIMUM RATINGS

2-1.ELECTRICAL ABSOLUTE RATINGS

DGND=0V

ITEM	SYMBOL	MIN.	MAX.	UNIT	COMMENT
Power Supply for Logic	VDD-DGND	-0.3	7	V	
Power Supply for Analog	AVDD-AGND	-0.3	13.5	V	
Input Voltage	VI	-0.3	VDD+0.3	V	
Static Electricity	—	—	—	—	Note 1

Note 1 LCM should be grounded during handling LCM.

2-2.ENVIRONMENTAL ABSOLUTE MAXIMUM RATINGS

ITEM	WIDE TEMP.			
	OPERATING		STORAGE	
	MIN.	MAX.	MIN.	MAX.
Ambient Temperature(°C)	-20	70	-30	80
Humidity (Without Condensation)	Note 2,4		Note 3,4	

Note 2 $T_a \leq 70^\circ\text{C}$: 75%RH MAX.

Note 3 Please refer to item of reliability test.

Note 4 Background color will change slightly depending on ambient temperature.
That phenomenon is reversible.

REV/DATE	R0/ 01.29.08'						BY C.Y.CHAN
----------	------------------	--	--	--	--	--	----------------

NAN YA PLASTICS CORP. ELEC. MATERIALS DIV. LCD DEPARTMENT	SPECIFICATION	SPEC. NO. : LM803-0 DATE : JAN. 29, 2008 SHEET NO. : 3-1
---	---------------	--

3.ELECTRICAL CHARACTERISTICS

3-1.ELECTRICAL CHARACTERISTICS OF LCM

ITEM	SYMBOL	CONDITION	MIN.	TYP.	MAX.	UNIT
Power Supply for Logic	VDD	VDD-DGND	3.0	3.3	3.6	V
Power Supply for Analog	AVDD	AVDD-AGND	—	10.0	—	
Input Voltage	VIH	H Level	0.7VDD	—	VDD	V
	VIL	L Level	0	—	0.3VDD	
Recommended LC Driving Voltage for 25°C	VGH	(Note)	—	15.0	—	V
	VGL		—	-10.0	—	
	VCOM		—	3.7	—	
Recommended LC Driving Current for 25°C	IVDD	VDD=3.3V, AVDD=10.0V VGH=15V, VGL=-10V Pattern : All on (White Color)	—	15.0	20.0	mA
Brightness	L	I _{AK} =60mA Pattern : All on (White Color)	250.0	300.0	—	cd/m ²

Note :

- (1) VGH is TFT Gate on operating Voltage.
- (2) VGL is TFT Gate off operating Voltage, VGL signal must be fluctuates with same phase as VCOM when Storage on Gate structure.
- (3) VCOM must be adjusted to optimize display quality_Crosstalk, Contrast Ratio and etc.

REV/DATE	R0/ 01.29.08'						BY C.Y.CHAN
----------	------------------	--	--	--	--	--	----------------

3-2.ELECTRICAL CHARACTERISTICS OF BACKLIGHT

Used LED Rating (Constant Current Driving)

Ta=25°C

ITEM	SYMBOL	MIN.	TYP.	MAX.	UNIT	REMARK
Peak forward current	IP	—	—	210	mA	—
Maximum reverse voltage	VR	—	—	15	V	—
Applied forward voltage	VAK	—	23.1	24.5	V	—
Applied forward current	IAK	—	60	—	mA	—
LED power consumption	PF	—	1.4	—	W	—
LED life time	LL	—	25000	—	Hrs	at IAK=60 mA (*1)

(*1) LED life time is defined as follows : The final brightness is at 50% of original brightness.

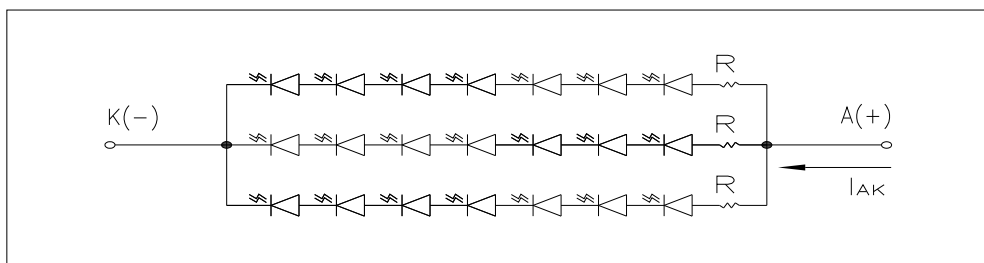

4.OPTICAL CHARACTERISTICS

4-1 Optical Char. of LCD Panel

Parameter	SYMBOL	Values			Unit	Note
		Min.	Typ.	Max.		
Response Time	Tr+Tf	—	50	80	ms	NOTE 2,3
Contrast Ratio	C/R	150	250	—	—	*a)
θ (Viewing Angle)	CR =10	12 O'Clock	—	60	—	NOTE 3,5
		6 O'Clock	—	40	—	
φ (Viewing Angle)		9 O'Clock	—	60	—	
		3 O'Clock	—	60	—	
Degree of Saturation	NTSC	—	53	—	%	

*a) Contrast Ratio(CR) is define mathematically as :

$$\text{Contrast Ratio} = \frac{\text{Surface Luminance with all white pixels}}{\text{Surface Luminance with all black pixels}}$$

SPECIFICATION

4-2. Color of CIE Coordinate

Ta=25°C

ITEM	SYMBOL	CONDITION	VALUE			NOTE
			MIN.	TYP.	MAX.	
Color of CIE Coordinate	Red	x	0.55	0.6	0.65	Note※
		y	0.31	0.36	0.41	
	Green	x	0.29	0.34	0.39	
		y	0.53	0.58	0.63	
	Blue	x	0.09	0.14	0.19	
		y	0.05	0.1	0.15	
	White	x	0.25	0.3	0.35	
		y	0.27	0.32	0.37	

Note※ Measuring at position 3 on Fig.1 CIE chromaticity diagram.

Base on Nan Ya Backlight (CIE X=0.30 ±0.03 , Y=0.30 ±0.03)

Fig.1

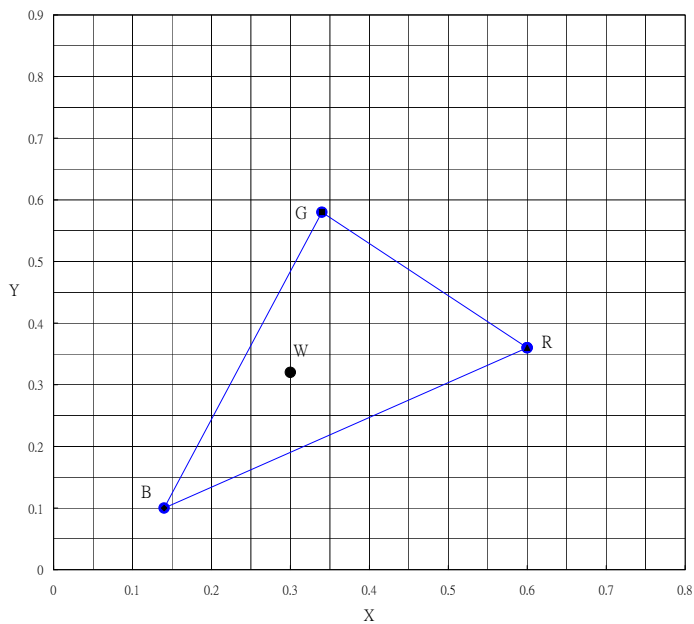

REV/DATE

R0/
01.29.08'

BY
C.Y.CHAN

(NOTE 1)

Definition of Operation Voltage(Vop)

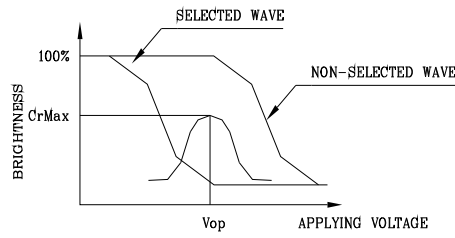

(positive type)

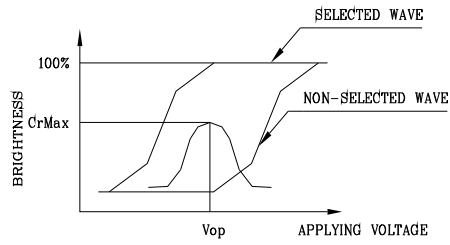

(negative type)

*Conditions

Viewing Angle : 0
 Frame Frequency : 70Hz
 Applying Waveform : 1/N duty 1/a bias

(NOTE 2)

Definition of Response Time(Tr,Tf)

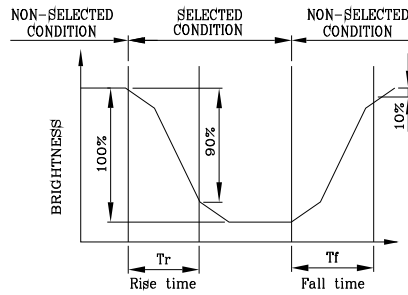

(positive type)

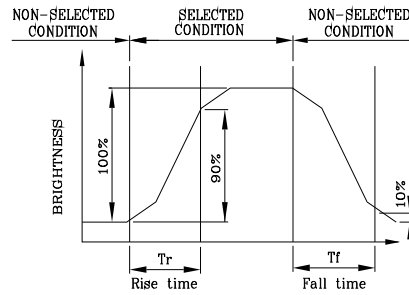

(negative type)

*Conditions

Operating Voltage : Vop
 Viewing Angle (θ,θ) : (0,0)
 Frame Frequency : 70Hz
 Applying Waveform : 1/N duty 1/a bias

(NOTE 3)

Description of Measuring Equipment and Driving Waveforms

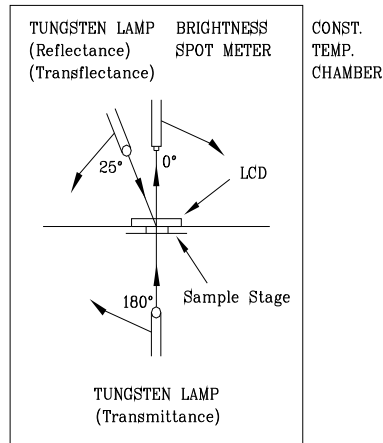

REV/DATE

R0/
01.29.08'

BY
C.Y.CHAN

(NOTE 4)

Definition of Viewing Direction

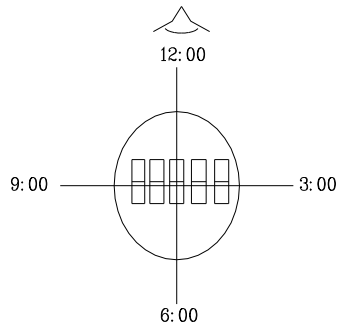

(NOTE 5)

Definition of Viewing Angle

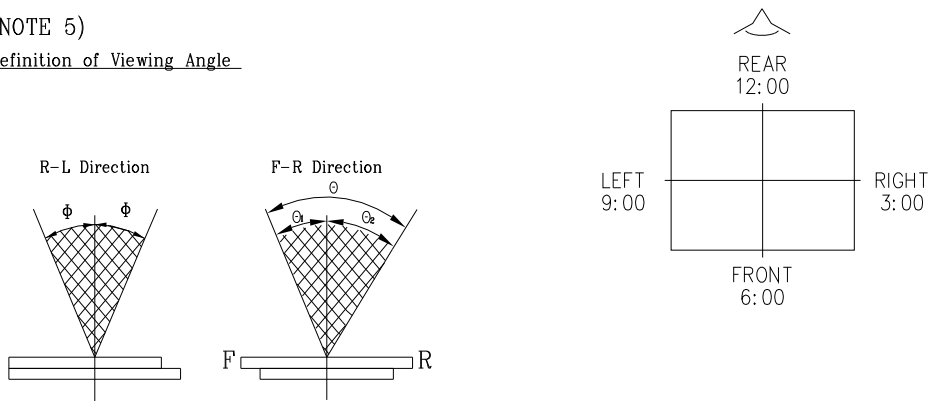

$$\theta = \theta_1 + \theta_2$$

*Conditions

Operating Voltage : V_{op}
 Frame Frequency : 70Hz
 Applying Waveform : 1/N duty 1/a bias
 Contrast Ratio : larger than 2

(NOTE 6)

Definition of Contrast Ratio (Cr)

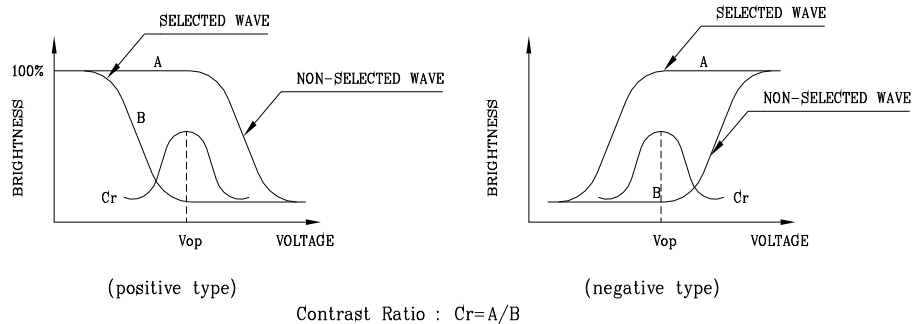

*Conditions

Viewing Angle : 0
 Frame Frequency : 70Hz
 Applying Waveform : 1/N duty 1/a bias

REV/DATE

R0/
01.29.08'

BY
C.Y.CHAN

5. BLOCK DIAGRAM

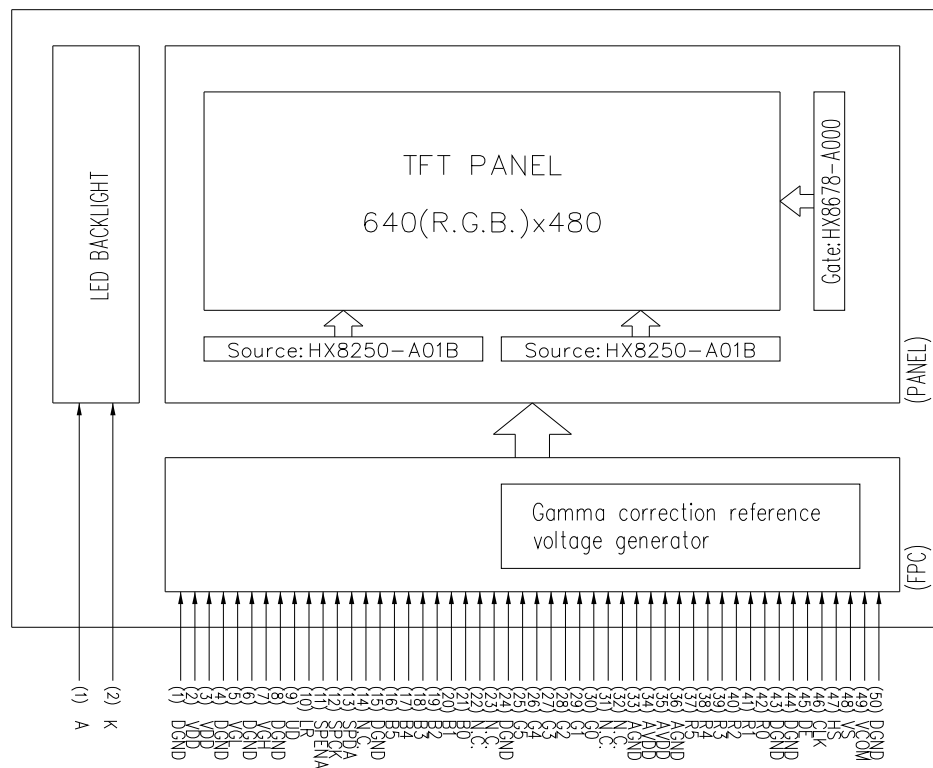

6.INTERNAL PIN CONNECTION

LCD (CN1)

Pin No.	Symbol	Pin No.	Symbol	Pin No.	Symbol	Pin No.	Symbol
1	DGND	16	B5	31	NC	46	CLK
2	VDD	17	B4	32	NC	47	HS
3	VDD	18	B3	33	AGND	48	VS
4	DGND	19	B2	34	AVDD	49	VCOM
5	VGL	20	B1	35	AVDD	50	DGND
6	DGND	21	B0	36	AGND		
7	VGH	22	NC	37	R5		
8	DGND	23	NC	38	R4		
9	UD	24	DGND	39	R3		
10	LR	25	G5	40	R2		
11	SPENA	26	G4	41	R1		
12	SPCK	27	G3	42	R0		
13	SPDA	28	G2	43	DGND		
14	NC	29	G1	44	DGND		
15	DGND	30	G0	45	DE		

USED LCD CABLE : FPC , pitch 0.5mm , 50 Pins , thickness 0.3mm.

CORRESPONDABLE LCD CONNECTOR : IRISO IMSA-9637S-50A-TB or COMPATIBLE

LED BACKLIGHT (CN2): JST BHSR-02VS-1

Pin No.	Symbol
1	A
2	K

CORRESPONDABLE BACKLIGHT CONNECTOR : SM02B-BHSS-1

REV/DATE

R0/
01.29.08'

BY

C.Y.CHAN

7.POWER SUPPLY

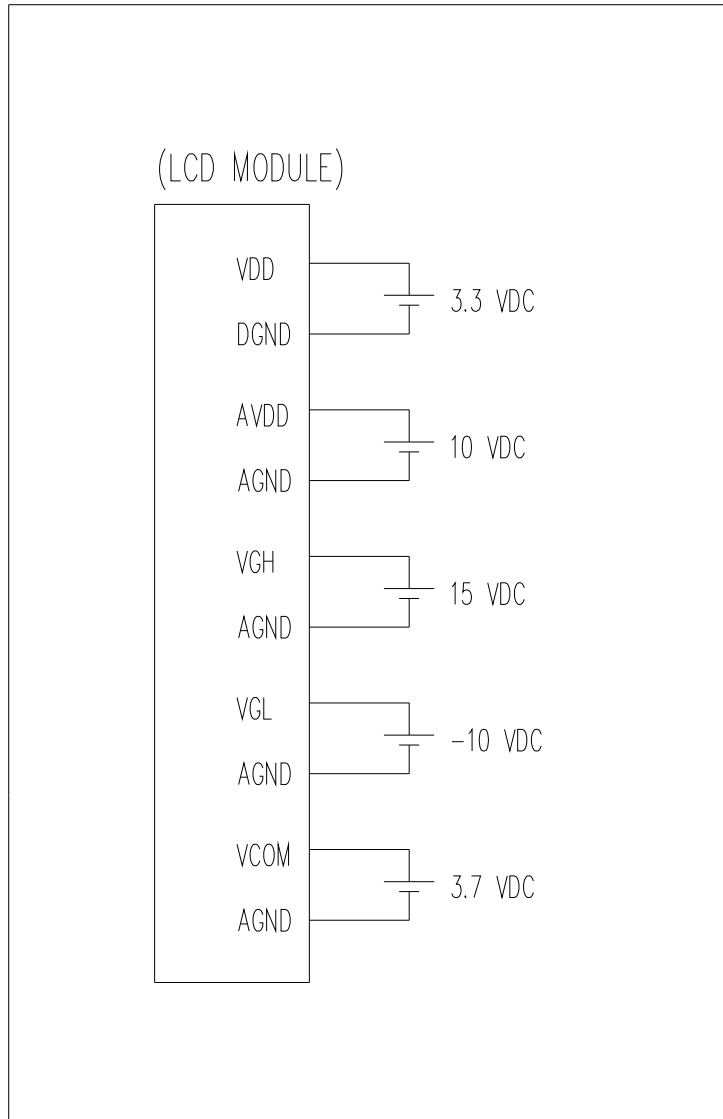

8.TIMING CHARACTERISTICS

8-1. AC TIMING CHARACTERISTICS

Please refer to the IC SPEC : (Himax) HX8250-A01B
 (Himax) HX8678-A000

(Himax Technologies, Inc)

8-2. POWER ON/OFF SEQUENCE

To prevent the device damage from latch up, the power ON/OFF sequence shown below must be followed.

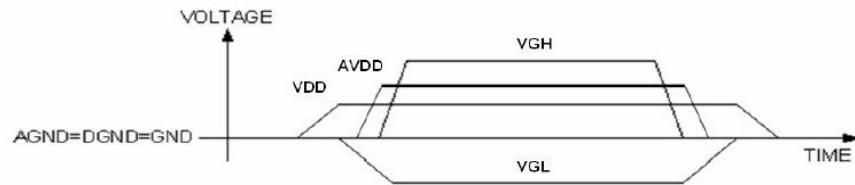

(NOTE) DISPLAY DIRECTION OF THE PANEL

The UD and LR control the Display direction of the panel.
 The settings of UD and LR are as following :



(1) UD=VDD and LR=DGND



(2) UD=VDD and LR=VDD

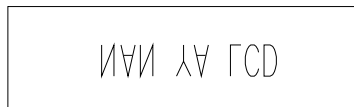

(3) UD=DGND and LR=DGND



(4) UD=DGND and LR=VDD

NAN YA PLASTICS CORP.
 ELEC. MATERIALS DIV.
 LCD DEPARTMENT

SPECIFICATION

SPEC. NO. : LM803-0
 DATE : JAN. 29, 2008
 SHEET NO. : 9-1

9.RELIABILITY TEST

WIDE TEMPERATURE RELIABILITY TEST

NO.	ITEM	CONDITION			STANDARD	NOTE
1	High Temp. Storage	80 °C	240 Hrs		Appearance without defect	
2	Low Temp. Storage	-30 °C	240 Hrs		Appearance without defect	
3	High Temp. & High Humi. Storage	60 °C 90%RH	240 Hrs		Appearance without defect	
4	High Temp. Operating Display	70 °C	240 Hrs		Appearance without defect	
5	Low Temp. Operating Display	-20 °C	240 Hrs		Appearance without defect	
6	Thermal Shock	-20 °C, 30min. → 70°C, 30min. ↑ (cycle) ↓			Appearance without defect	10 cycles

REV/DATE

R0/
01.29.08'

BY
C.Y.CHAN

SPECIFICATION

Inspection Provision

1.Purpose

The NAN YA inspection provision provides outgoing inspection provision and its expected quality level based on our outgoing inspection of NAN YA LCD produces.

2.Applicable Scope

The NAN YA inspection provision is applicable to the arrangement in regard to outgoing inspection and quality assurance after outgoing.

3.Technical Terms

3-1 NAN YA Technical Terms



4.Outgoing Inspection

4-1 Inspection Method

MIL-STD-105E Level II Regular inspection

4-2 Inspection Standard

	Item		AQL(%)	Remarks
Major Defect	Dots	Opens	0.4	faults which substantially lower the practicality and the initial purpose difficult to achieve.
		Shorts		
	Erroneous operation			
Solder appearance	Shorts	0.4		
	Loose			
Cracks	Display surface cracks			

REV/DATE

R0/
01.29.08'

BY
C.Y.CHAN

NAN YA PLASTICS CORP. ELEC. MATERIALS DIV. LCD DEPARTMENT	SPECIFICATION	SPEC. NO. : LM803-0 DATE : JAN. 29, 2008 SHEET NO. : 9-4
---	---------------	--

*Test and measurement are performed under the following conditions, unless otherwise specified.

Temperature	20 ± 15°C
Humidity	65 ± 20%R.H.
Pressure	860~1060hPa(mmbar)

In case of doubtful judgment, it is performed under the following conditions.

Temperature	20 ± 2°C
Humidity	65 ± 5%R.H.
Pressure	860~1060hPa(mmbar)

5.Specification for quality check

5-1-1 Electrical characteristics :

NO.	Item	Criterion
1	Non operational	Fail
2	Miss operating	Fail
3	Contrast irregular	Fail
4	Response time	Within Specified value

5-1-2 Components soldering :

Should be no defective soldering such as shorting, loose terminal cold solder, peeling of printed circuit board pattern, improper mounting position, etc.

5-2 Inspection Standard for TFT panel

5-2-1 The environmental condition of inspection :

The environmental condition and visual inspection shall be conducted as below.

- (1) Ambient temperature : 25±5°C
- (2) Humidity : 25~75% RH
- (3) External appearance inspection shall be conducted by using a single 20W fluorescent lamp or equivalent illumination.
- (4) Visual inspection on the operation condition for cosmetic shall be conducted at the distance 30cm or more between the LCD panels and eyes of inspector. The viewing angle shall be 90 degree to the front surface of display panel.
- (5) Ambient Illumination : 300~500 Lux for external appearance inspection.
- (6) Ambient Illumination : 100~200 Lux for light on inspection.

REV/DATE	R0/ 01.29.08'						BY C.Y.CHAN
----------	------------------	--	--	--	--	--	----------------

5-2-2 Inspection Criteria

(1) Definition of dot defect induced from the panel inside

- a) The definition of dot : The size of a defective dot over 1/2 of whole dot is regarded as one defective dot.
- b) Bright dot : Dots appear bright and unchanged in size in which LCD panel is displaying under black pattern.
- c) Dark dot : Dots appear dark and unchanged in size in which LCD panel is displaying under pure red, green, blue pattern.
- d) 2 dot adjacent = 1 pair = 2 dots

Picture :



2 dot adjacent



2 dot adjacent (vertical)

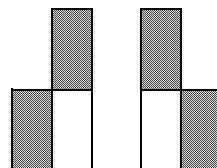

2 dot adjacent (slant)

(2) Display Inspection

NO.	Item		Acceptable Count
1	Dot defect	Bright Dot	Random $N \leq 2$
			2 dots adjacent $N \leq 0$
	Dark Dot	Random	$N \leq 3$
			2 dots adjacent $N \leq 1$
	Total bright and dark dot		$N \leq 4$
Functional failure (V-line/ H-line/Cross line etc.)		Not allowable	
	Mura	It's OK if mura is slight visible through 6% ND filter. (Judged by limit sample if it is necessary)	
2	Newton ring (touch panel)	Orbicular of interference fringes is not allowed in the optimum contrast within the active area under viewing angle.	

NAN YA PLASTICS CORP. ELEC. MATERIALS DIV. LCD DEPARTMENT	SPECIFICATION	SPEC. NO. : LM803-0 DATE : JAN. 29, 2008 SHEET NO. : 9-6
---	----------------------	--

(3) Appearance inspection

NO.	Item	Standards
1	Panel Crack	Not allow. It is shown in Fig.1.
2	Broken CF Non-lead Side of TFT	The broken in the area of $W > 2\text{mm}$ is ignored, L is ignored. It is shown in Fig.2.
3	Broken Lead Side of TFT	FPC lead, electrical line or alignment mark can't be damaged. It is shown in Fig.3.
4	Broken Corner of TFT at Lead Side	FPC lead. electrical line or alignment mark can't be damaged. It is shown in Fig.4.
5	Burr of TFT / CF Edge	The distance of burr from the edge of TFT / CF, $W \leq 0.3\text{mm}$. It is shown in Fig.5.
6	Foreign Black / White/Bright Spot	(1) $0.15 < D \leq 0.5 \text{ mm}$, $N \leq 4$; (2) $D \leq 0.15\text{mm}$, Ignore. It is shown in Fig.6.
7	Foreign Black / White/Bright Line	(1) $0.05 < W \leq 0.1 \text{ mm}$, $0.3 < L \leq 2 \text{ mm}$, $N \leq 4$.
		(2) $W \leq 0.05\text{mm}$ and $L \leq 0.3\text{mm}$ Ignore. It is shown in Fig.7.
8	Color irregular	Not remarkable color irregular.

REV/DATE	R0/ 01.29.08'							BY C.Y.CHAN
----------	------------------	--	--	--	--	--	--	----------------

Fig.1.

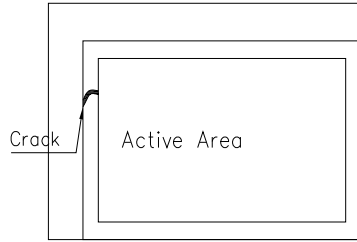

Fig.2.

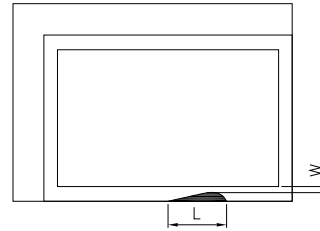

Fig.3.

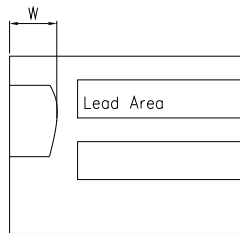

Fig.4.

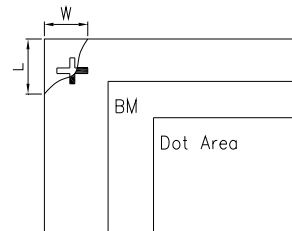

Fig.5.

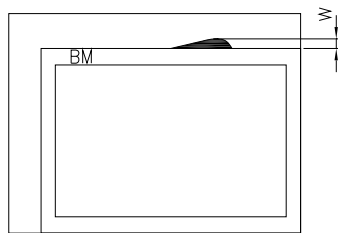
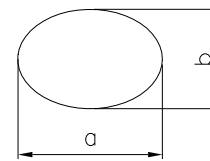

Fig.6.



$$D = (a+b)/2$$

Fig.7.

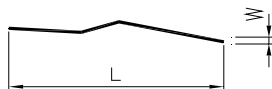
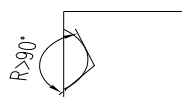

Fig.8.



Notes

1. W : Width
2. L : Length
3. D : Average Diameter
4. N : Count
5. All the angle of the broken must be larger than 90°. It is shown in Fig.8. (R>90°)

REV/DATE

R0/
01.29.08'

BY
C.Y.CHAN

NAN YA PLASTICS CORP. ELEC. MATERIALS DIV. LCD DEPARTMENT	SPECIFICATION				SPEC. NO. : LM803-0 DATE : JAN. 29, 2008 SHEET NO. : 9-8	
<p>NOTICE:</p> <ul style="list-style-type: none"> • SAFETY <ol style="list-style-type: none"> 1. If the LCD panel breaks, be careful not to get the liquid crystal to touch your skin. 2. If the liquid crystal touches your skin or clothes, please wash it off immediately by using soap and water. • HANDLING <ol style="list-style-type: none"> 1. Avoid static electricity which can damage the CMOS LSI. 2. Do not remove the panel or frame from the module. 3. The polarizing plate of the display is very fragile. So, please handle it very carefully. 4. Do not wipe the polarizing plate with a dry cloth, as it may easily scratch the surface of plate. 5. Do not use ketonics solvent & Aromatic solvent. Use a soft cloth soaked with a cleaning naphtha solvent. • STORAGE <ol style="list-style-type: none"> 1. Store the panel or module in a dark place where the temperature is $25\pm 5^{\circ}\text{C}$ and the humidity is below 65% RH. 2. Do not place the module near organics solvents or corrosive gases. 3. Do not crush, shake, or jolt the module. • TERMS OF WARRANT <ol style="list-style-type: none"> 1. Acceptance inspection period The period is within one month after the arrival of contracted commodity at the buyer's factory site. 2. Applicable warrant period The period is within twelve months since the date of shipping out under normal using and storage conditions. 						
REV/DATE	R0/ 01.29.08'					BY C.Y.CHAN

SPECIFICATION

10.OUTLINE DRAWING

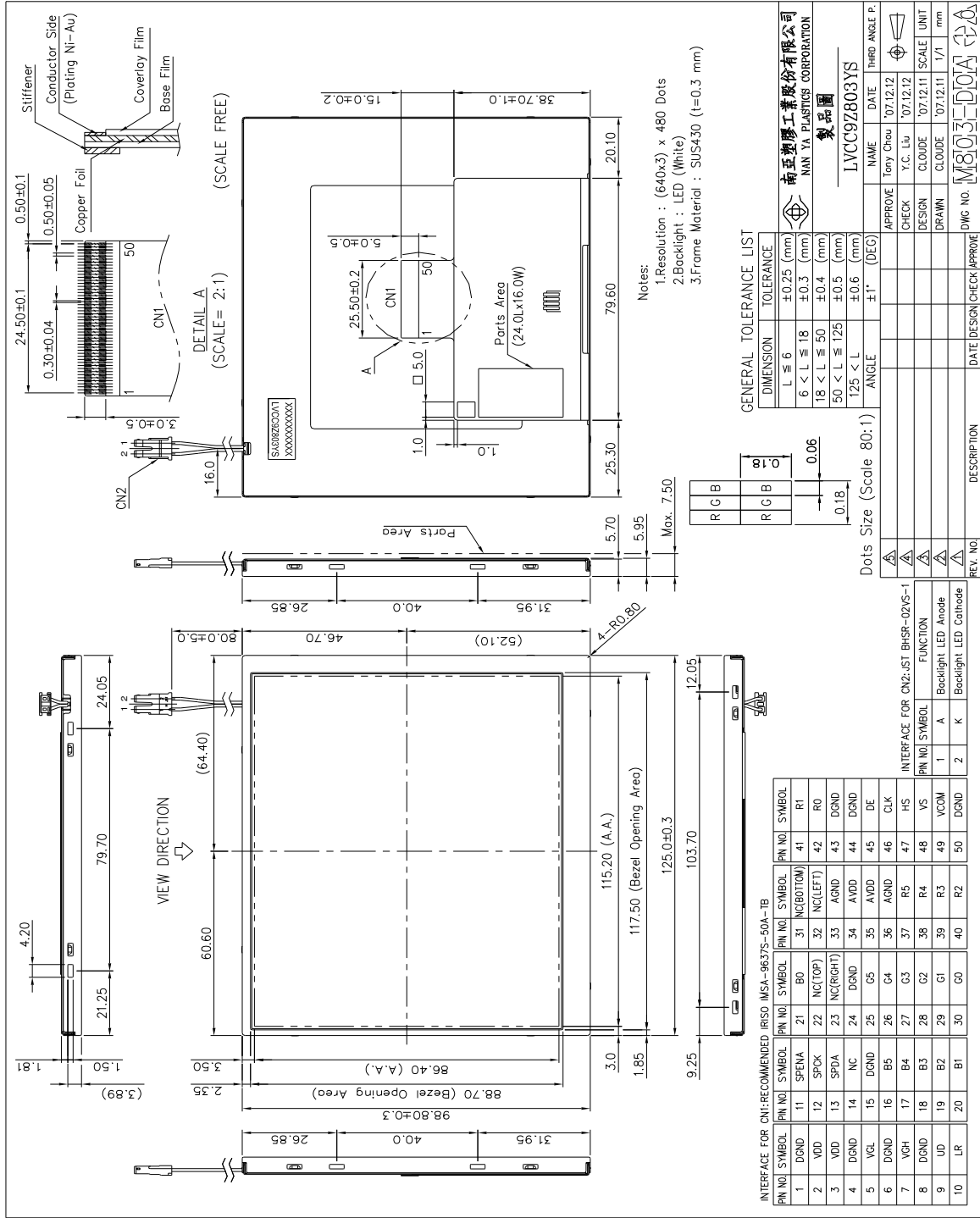

REV/DATE R0/ 01.29.08'

BY C.Y.CHAN