



Features

- Package with screw terminals
- Isolation voltage 3000 V~
- Planar passivated chips
- Blocking voltage up to 1600 V
- Low forward voltage drop
- UL registered E72873



Applications

- Supplies for DC power equipment
- Input rectifiers for PWM inverter
- Battery DC power supplies
- Field supply for DC motors

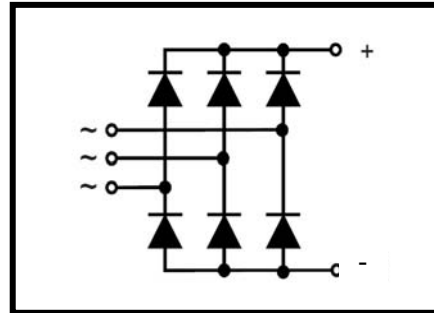

Advantages

- Easy to mount with two screws
- Space and weight savings
- Improved temperature and power cycling

ABSOLUTE MAXIMUM RATINGS

T_C=25°C unless otherwise specified

Symbol	Test Condition	Value	Unit
V _R RM		1200	V
I _d (AV)	T _C =100 , module	250	A
I _{FSM}	T _J =45 ; t=10ms (50Hz),sine	2500	A
	V _R =0 t=8.3ms(60Hz),sine	2800	A
	T _J =150 ; t=10ms (50Hz),sine	2000	A
	V _R =0 t=8.3ms(60Hz),sine	2250	A
I ² t	T _J =45 ; t=10ms (50Hz),sine	31250	A ² s
	V _R =0 t=8.3ms(60Hz),sine	39200	A ² s
	T _J =150 ; t=10ms (50Hz),sine	20000	A ² s
	V _R =0 t=8.3ms(60Hz),sine	25300	A ² s
T _J ,T _{STG}		-40 to +150	
T _{JM}		150	
V _{ISOL}	50/60Hz RMS t=1 min	2500	V~
	I _{ISOL} ≤1mA t=1 s	3000	V~
Md	Mounting torque(M6)	5±15%	N·m
	Terminal connection torque(M6)	5±15%	N·m
Weight	typical	241	g

ELECTRICAL AND THERMAL CHARACTERISTICS $T_C=25^{\circ}\text{C}$ unless otherwise specified

Symbol	Test Condition	Value	Unit
I_R	$V_R = V_{RRM}; T_J = 25$	≤ 0.5	mA
	$V_R = V_{RRM}; T_J = T_{JM}$	≤ 5	mA
V_F	$I_F = 300\text{A}; T_J = 125$	1.43	V
V_{T0}	For power-loss calculations only	0.8	V
R_{thJC}	per diode	0.48	K/W
	Per module	0.08	K/W
R_{thCS}	per diode	0.18	K/W
	per module	0.03	K/W
d_S	Creeping distance on surface	10	mm
d_A	Cree page distance in air	9.4	mm
a	Max. allowable acceleration	50	m/s^2

NOTE: Data according to IEC 60747 and refer to a single diode unless otherwise stated.

Package Outline (Dimensions in mm)

