

features

- Excellent for high frequency applications
- Low DC resistance and high Q
- Operating temperature: -40°C ~ +125°C
- Low tolerance ±2% available
- Small size allows for high density mounting (1E, 1J, 2A, 2B)
- Marking: Yellow marking on blue protective coating (1E, 1J, 2A, 2B)
- Products with lead-free terminations meet EU RoHS and China RoHS requirements
- AEC-Q200 Qualified

dimensions and construction

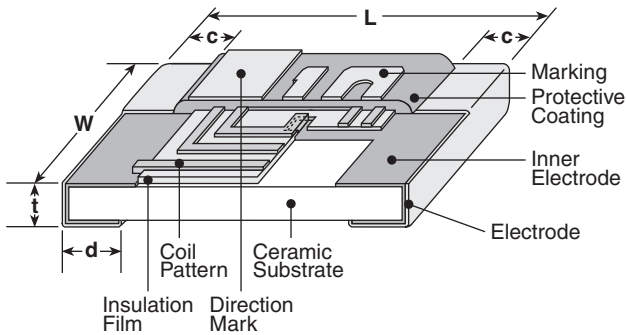

Type (Inch Size Code)	Dimensions inches (mm)				
	L	W	c	d	t
1E (0402)	.039±.004 (1.0±0.1)	.02±.002 (0.5±0.05)	.006±.004 (0.15±0.1)	.01±.004 (0.25±0.1)	.014±.002 (0.35±0.05)
1J (0603)	.063±.008 (1.6±0.2)	.031±.004 (0.8±0.1)	.012±.004 (0.3±0.1)	.012±.004 (0.3±0.1)	.02±.004 (0.5±0.1)
2A (0805)	.079±.008 (2.0±0.2)	.049±.008 (1.25±0.2)	.016±.008 (0.4±0.2)	.012±.004 (0.3±0.2)	.02±.004 (0.5±0.1)
2B (1206)	.126±.008 (3.2±0.2)	.063±.008 (1.6±0.2)	.02±.008 (0.5±0.2)	.016 ^{+0.008} _{-.004} (0.4 ^{+0.2} _{-.1})	.024±.004 (0.6±0.1)

Inductance Marking

Part 1J (nH)	Marking
1.0	L1
1.2	L2
1.5	L3
1.8	L4
2.2	22
2.7	27
3.3	33
3.9	39
4.7	47
5.6	56
6.8	68
8.2	82

Part 1J (nH)	Marking
10	10
12	12
15	15
18	H1
22	H2
27	H3
33	H4
39	H5
47	H6
56	H7
68	H8
82	H9

Part Marking	Value (nH) 2.2 - 8.2	Value (nH) 10 and higher
2A	Ex. = 2.2 = 2.2nH	Ex. = 15 = 15nH
2B	Ex. = 2N2 = 2.2nH	Ex. = 15N = 15nH

No marking on 1E (0402)

ordering information

New Part #	KL73	2A	T	TE	4N7	G
	Type	Size Code	Termination Material	Packaging	Nominal Inductance	Tolerance
		1E: 0402 1J: 0603 2A: 0805 2B: 1206	T: Sn	TP: 7" paper 2mm pitch (1E only - 10,000 pieces/reel) TE: 7" embossed plastic 4mm pitch (1J, 2A, 2B - 4,000 pieces/reel)	4N7: 4.7nH 47N: 47nH	B: ±0.1nH C: ±0.2nH G: ±2% J: ±5%

For further information on packaging, please refer to Appendix A.

applications and ratings

Part Designation	Nominal Inductance (nH)	Inductance Tolerance	Quality Factor Minimum	Self Resonant Frequency Minimum (MHz)	DC Resistance Maximum (Ω)	Allowable DC Current Maximum (mA)	Measured Frequency (MHz)**			
KL731ETTPN56B	0.56	B: ± 0.1 nH	7	14000	0.10	700	500			
KL731ETTPN68B	0.68									
KL731ETTPN82B	0.82									
KL731ETTP1N0*	1.0	B: ± 0.1 nH C: ± 0.2 nH	10	12000	0.15	650	500			
KL731ETTP1N2*	1.2			10000	0.20					
KL731ETTP1N5*	1.5			8000	0.25					
KL731ETTP1N8*	1.8			6000	0.30					
KL731ETTP2N2*	2.2			5000	0.50					
KL731ETTP2N7*	2.7				600					
KL731ETTP3N3*	3.3			4000	1.00			600		
KL731ETTP3N9*	3.9							550		
KL731ETTP4N7*	4.7			3000	1.50			500		
KL731ETTP5N6*	5.6							450		
KL731ETTP6N8*	6.8	2500	2.00	350						
KL731ETTP8N2*	8.2			300						
KL731ETTP10N*	10	2000	3.00	250						
KL731ETTP12N*	12			200						
KL731ETTP15N*	15	7	1500	5.00	150	200				
KL731ETTP18N*	18									
KL731ETTP22N*	22									
KL731ETTP27N*	27									
KL731ETTP33N*	33		1000							
KL731JTTE1N0*	1.0	C: ± 0.2 nH	10	13000	0.10	650	500			
KL731JTTE1N2*	1.2		15							
KL731JTTE1N5*	1.5		20					10000		
KL731JTTE1N8*	1.8							8000	0.15	
KL731JTTE2N2*	2.2							450		
KL731JTTE2N7*	2.7							6000	0.25	
KL731JTTE3N3*	3.3		25					5000	0.50	350
KL731JTTE3N9*	3.9							4000		
KL731JTTE4N7*	4.7							3000		
KL731JTTE5N6*	5.6							2500		
KL731JTTE6N8*	6.8	2000	1.50	250	200					
KL731JTTE8N2*	8.2									
KL731JTTE10N*	10									
KL731JTTE12N*	12									
KL731JTTE15N*	15	10	1500	2.50	150					
KL731JTTE18N*	18									
KL731JTTE22N*	22									
KL731JTTE27N*	27									
KL731JTTE33N*	33	G: $\pm 2\%$ J: $\pm 5\%$	1000	2.50	150	200				
KL731JTTE39N*	39									
KL731JTTE47N*	47									
KL731JTTE56N*	56									
KL731JTTE68N*	68		600	4.00	120					
				4.50	100					

* Add tolerance character (B, C, G, J)

** The operating temperature range of the coil (ambient temperature + self heating) must remain at +125°C or less

For complete environmental specifications, please refer to www.koaspeer.com

Specifications given herein may be changed at any time without prior notice. Please confirm technical specifications before you order and/or use.

12/01/14

applications and ratings (continued)

Part Designation	Nominal Inductance (nH)	Inductance Tolerance	Quality Factor Minimum	Self Resonant Frequency Minimum (MHz)	DC Resistance Maximum (Ω)	Allowable DC Current Maximum (mA)	Measured Frequency (MHz)**		
KL732ATTE1N0*	1.0	C: $\pm 0.2\text{nH}$	20	13000	0.25	900	500		
KL732ATTE1N2*	1.2			10000					
KL732ATTE1N5*	1.5			9000					
KL732ATTE1N8*	1.8		25	8000		0.50		800	
KL732ATTE2N2*	2.2			6000					
KL732ATTE2N7*	2.7			5000					
KL732ATTE3N3*	3.3			4500				700	
KL732ATTE3N9*	3.9			4000					
KL732ATTE4N7*	4.7			3000					
KL732ATTE5N6*	5.6			G: $\pm 2\%$ J: $\pm 5\%$				20	2500
KL732ATTE6N8*	6.8	2000							
KL732ATTE8N2*	8.2	1500							
KL732ATTE10N*	10	15	1000		1.50	250			
KL732ATTE12N*	12		800						
KL732ATTE15N*	15		10			700	4.00	150	
KL732ATTE18N*	18					600			
KL732ATTE22N*	22					C: $\pm 0.2\text{nH}$			9000
KL732ATTE27N*	27		7000						
KL732ATTE33N*	33		6000						
KL732ATTE39N*	39	35	5000	0.50	900				
KL732ATTE47N*	47		4500						
KL732ATTE56N*	56		4000						
KL732ATTE68N*	68		3500		800				
KL732ATTE82N*	82		3000						
KL732ATTE100*	100		2500						
KL732BTTE2N2*	2.2		G: $\pm 2\%$ J: $\pm 5\%$		40		2000	1.00	500
KL732BTTE2N7*	2.7	1500							
KL732BTTE3N3*	3.3	25		1000		2.00	400		
KL732BTTE3N9*	3.9			1000					
KL732BTTE4N7*	4.7			500					
KL732BTTE5N6*	5.6			15	500		2.00		200
KL732BTTE6N8*	6.8				400				
KL732BTTE8N2*	8.2				400				

* Add tolerance character (B, C, G, J)

** The operating temperature range of the coil (ambient temperature + self heating) must remain at $+125^\circ\text{C}$ or less

For L-Frequency and Q-Frequency Characteristics, see Environmental Applications at www.koaspeer.com

environmental applications

Performance Characteristics

Parameter	Requirements Maximum Limit	Δ L/L Δ Q/Q Typical	Test Method
Resistance to Soldering Heat	Without distinct damage in appearance and construction Δ L/L: $\pm 2\%$, Δ Q/Q: $\pm 20\%$	Δ L/L: $\pm 0.5\%$ Δ Q/Q: $\pm 1.5\%$	260°C \pm 5°C, 10s \pm 1s
Rapid Change of Temperature	Without distinct damage in appearance and construction Δ L/L: $\pm 2\%$, Δ Q/Q: $\pm 20\%$	Δ L/L: $\pm 0.5\%$ Δ Q/Q: $\pm 1.6\%$	-40°C (30min.)/ +125°C (30min.) 100 cycles
Low Temperature Exposure	Without distinct damage in appearance and construction Δ L/L: $\pm 2\%$, Δ Q/Q: $\pm 20\%$	Δ L/L: $\pm 0.7\%$ Δ Q/Q: $\pm 1.2\%$	-40°C \pm 3°C, 1000h
High Temperature Exposure	Without distinct damage in appearance and construction Δ L/L: $\pm 2\%$, Δ Q/Q: $\pm 20\%$	Δ L/L: $\pm 0.4\%$ Δ Q/Q: $\pm 1.3\%$	125°C \pm 2°C, 1000h
Moisture Exposure	Without distinct damage in appearance and construction Insulation resistance: 50M Ω or more Δ L/L: $\pm 2\%$, Δ Q/Q: $\pm 20\%$	Δ L/L: $\pm 0.4\%$ Δ Q/Q: $\pm 1.4\%$	40°C \pm 2°C, 90%~95%RH, 1000h
Resistance to Solvent	Without distinct damage in appearance, construction and marking Δ L/L: $\pm 2\%$, Δ Q/Q: $\pm 20\%$	Δ L/L: $\pm 0.6\%$ Δ Q/Q: $\pm 1.2\%$	Immerse the inductors for 30s \pm 5s in the reagent (20°C ~ 25°C) of JIS K8839 (1995)

Frequency Characteristics Test equipment: HP4291B impedance analyzer (1E, 1J, 2A, 2B)

L - Frequency Characteristics

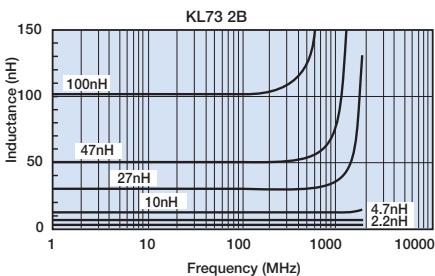
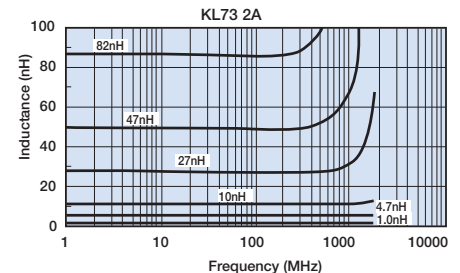
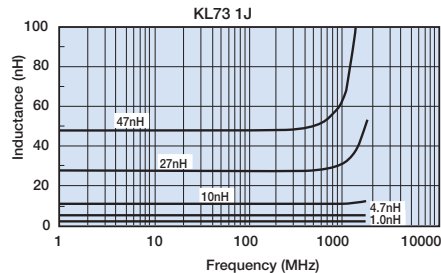
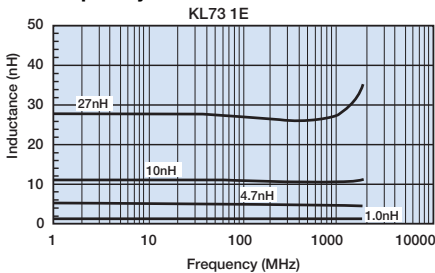

Q - Frequency Characteristics

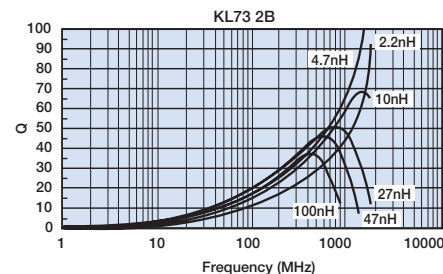
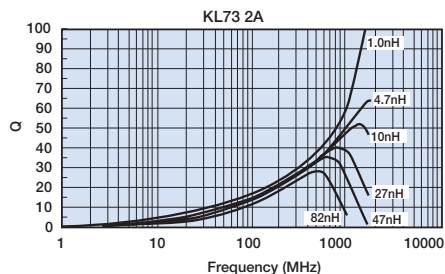
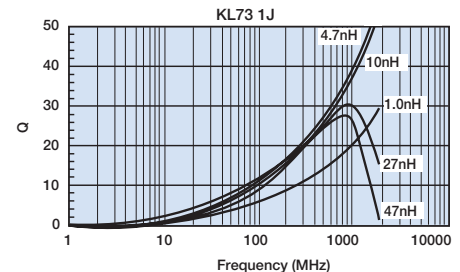
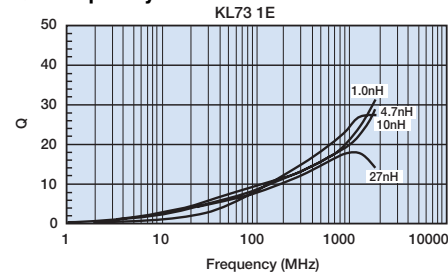

Specifications given herein may be changed at any time without prior notice. Please confirm technical specifications before you order and/or use.

11/21/14