

## Full - Bridge NPT IGBT Power Module

**$V_{CES} = 1200V$   
 $I_C = 50A @ T_c = 80^\circ C$**

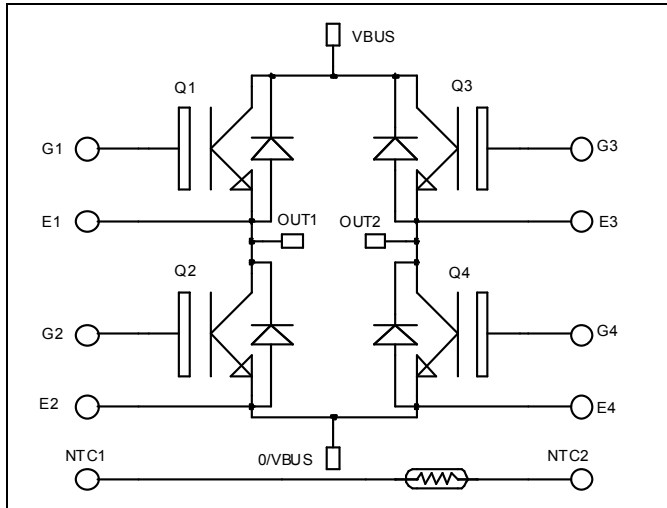

### Application

- Welding converters
- Switched Mode Power Supplies
- Uninterruptible Power Supplies
- Motor control

### Features

- Non Punch Through (NPT) FAST IGBT
  - Low voltage drop
  - Low tail current
  - Switching frequency up to 50 kHz
  - Soft recovery parallel diodes
  - Low diode VF
  - Low leakage current
  - Avalanche energy rated
  - RBSOA and SCSOA rated
- Kelvin emitter for easy drive
- Very low stray inductance
  - Symmetrical design
  - Lead frames for power connections
- Internal thermistor for temperature monitoring
- High level of integration

### Benefits

- Outstanding performance at high frequency operation
- Stable temperature behavior
- Very rugged
- Direct mounting to heatsink (isolated package)
- Low junction to case thermal resistance
- Solderable terminals both for power and signal for easy PCB mounting
- Easy paralleling due to positive TC of VCESat
- Low profile

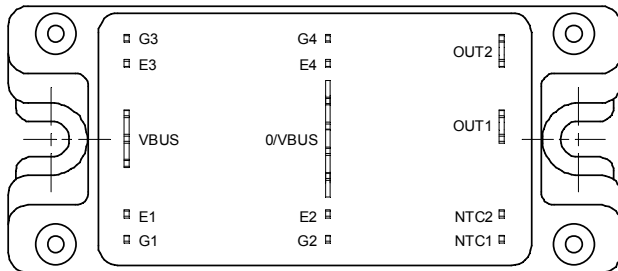

### Absolute maximum ratings

Symbol	Parameter	Max ratings	Unit
$V_{CES}$	Collector - Emitter Breakdown Voltage	1200	V
$I_C$	Continuous Collector Current	$T_c = 25^\circ C$	75
		$T_c = 80^\circ C$	50
$I_{CM}$	Pulsed Collector Current	$T_c = 25^\circ C$	150
$V_{GE}$	Gate - Emitter Voltage	$\pm 20$	V
$P_D$	Maximum Power Dissipation	$T_c = 25^\circ C$	312
RBSOA	Reverse Bias Safe Operating Area	$T_j = 150^\circ C$	150A @ 1200V

**CAUTION:** These Devices are sensitive to Electrostatic Discharge. Proper Handling Procedures Should Be Followed.

All ratings @  $T_j = 25^\circ\text{C}$  unless otherwise specified

## Electrical Characteristics

Symbol	Characteristic	Test Conditions	Min	Typ	Max	Unit
$BV_{CES}$	Collector - Emitter Breakdown Voltage	$V_{GE} = 0\text{V}, I_C = 500 \mu\text{A}$	1200			V
$I_{CES}$	Zero Gate Voltage Collector Current	$V_{GE} = 0\text{V}$			500	$\mu\text{A}$
		$V_{CE} = 1200\text{V}$			2500	
$V_{CE(on)}$	Collector Emitter on Voltage	$V_{GE} = 15\text{V}$		3.2	3.7	V
		$I_C = 50\text{A}$		4.0		
$V_{GE(th)}$	Gate Threshold Voltage	$V_{GE} = V_{CE}, I_C = 1 \text{mA}$	4.5		6.5	V
$I_{GES}$	Gate - Emitter Leakage Current	$V_{GE} = \pm 20 \text{V}, V_{CE} = 0\text{V}$			100	nA

## Dynamic Characteristics

Symbol	Characteristic	Test Conditions	Min	Typ	Max	Unit
$C_{ies}$	Input Capacitance	$V_{GE} = 0\text{V}$		3450		pF
$C_{oes}$	Output Capacitance	$V_{CE} = 25\text{V}$		330		
$C_{res}$	Reverse Transfer Capacitance	$f = 1\text{MHz}$		220		
$Q_g$	Total gate Charge	$V_{GS} = 15\text{V}$		330		nC
$Q_{ge}$	Gate - Emitter Charge	$V_{Bus} = 600\text{V}$		35		
$Q_{gc}$	Gate - Collector Charge	$I_C = 50\text{A}$		200		
$T_{d(on)}$	Turn-on Delay Time	Inductive Switching ( $25^\circ\text{C}$ )		35		ns
$T_r$	Rise Time	$V_{GE} = 15\text{V}$		65		
$T_{d(off)}$	Turn-off Delay Time	$V_{Bus} = 600\text{V}$		320		
$T_f$	Fall Time	$I_C = 50\text{A}$		30		
$E_{on}$	Turn-on Switching Energy ①	$R_G = 5 \Omega$		5.4		
$E_{off}$	Turn-off Switching Energy ②			2.3		mJ
$T_{d(on)}$	Turn-on Delay Time	Inductive Switching ( $125^\circ\text{C}$ )		35		ns
$T_r$	Rise Time	$V_{GE} = 15\text{V}$		65		
$T_{d(off)}$	Turn-off Delay Time	$V_{Bus} = 600\text{V}$		360		
$T_f$	Fall Time	$I_C = 50\text{A}$		40		
$E_{on}$	Turn-on Switching Energy ①	$R_G = 5 \Omega$		6.9		
$E_{off}$	Turn-off Switching Energy ②			3.05		mJ

## Reverse diode ratings and characteristics

Symbol	Characteristic	Test Conditions	Min	Typ	Max	Unit
$I_{F(AV)}$	Maximum Average Forward Current	50% duty cycle   $T_c = 70^\circ\text{C}$		60		A
$V_F$	Diode Forward Voltage	$I_F = 60\text{A}$		2.0	2.5	V
		$I_F = 120\text{A}$		2.3		
		$I_F = 60\text{A}$   $T_j = 125^\circ\text{C}$		1.8		
$t_{rr}$	Reverse Recovery Time	$I_F = 60\text{A}$   $T_j = 25^\circ\text{C}$		370		ns
		$V_R = 800\text{V}$   $di/dt = 400\text{A}/\mu\text{s}$   $T_j = 125^\circ\text{C}$		500		
$Q_{rr}$	Reverse Recovery Charge	$I_F = 60\text{A}$   $T_j = 25^\circ\text{C}$		1320		nC
		$V_R = 800\text{V}$   $di/dt = 400\text{A}/\mu\text{s}$   $T_j = 125^\circ\text{C}$		6900		

①  $E_{on}$  includes diode reverse recovery

② In accordance with JEDEC standard JESD24-1

**Thermal and package characteristics**

Symbol	Characteristic	Min	Typ	Max	Unit	
R <sub>thJC</sub>	Junction to Case	IGBT		0.4	°C/W	
		Diode		0.65		
V <sub>ISOL</sub>	RMS Isolation Voltage, any terminal to case t=1 min, I <sub>isol</sub> <1mA, 50/60Hz	2500			V	
T <sub>J</sub>	Operating junction temperature range	-40		150	°C	
T <sub>STG</sub>	Storage Temperature Range	-40		125		
T <sub>C</sub>	Operating Case Temperature	-40		100		
Torque	Mounting torque	To Heatsink	M5		4.7	N.m
Wt	Package Weight			160		g

**Temperature sensor NTC**

Symbol	Characteristic	Min	Typ	Max	Unit
R <sub>25</sub>	Resistance @ 25°C		68		kΩ
B <sub>25/85</sub>	T <sub>25</sub> = 298.16 K		4080		K

$$R_T = \frac{R_{25}}{\exp\left[B_{25/85}\left(\frac{1}{T_{25}} - \frac{1}{T}\right)\right]}$$

T: Thermistor temperature  
R<sub>T</sub>: Thermistor value at T

**Package outline**

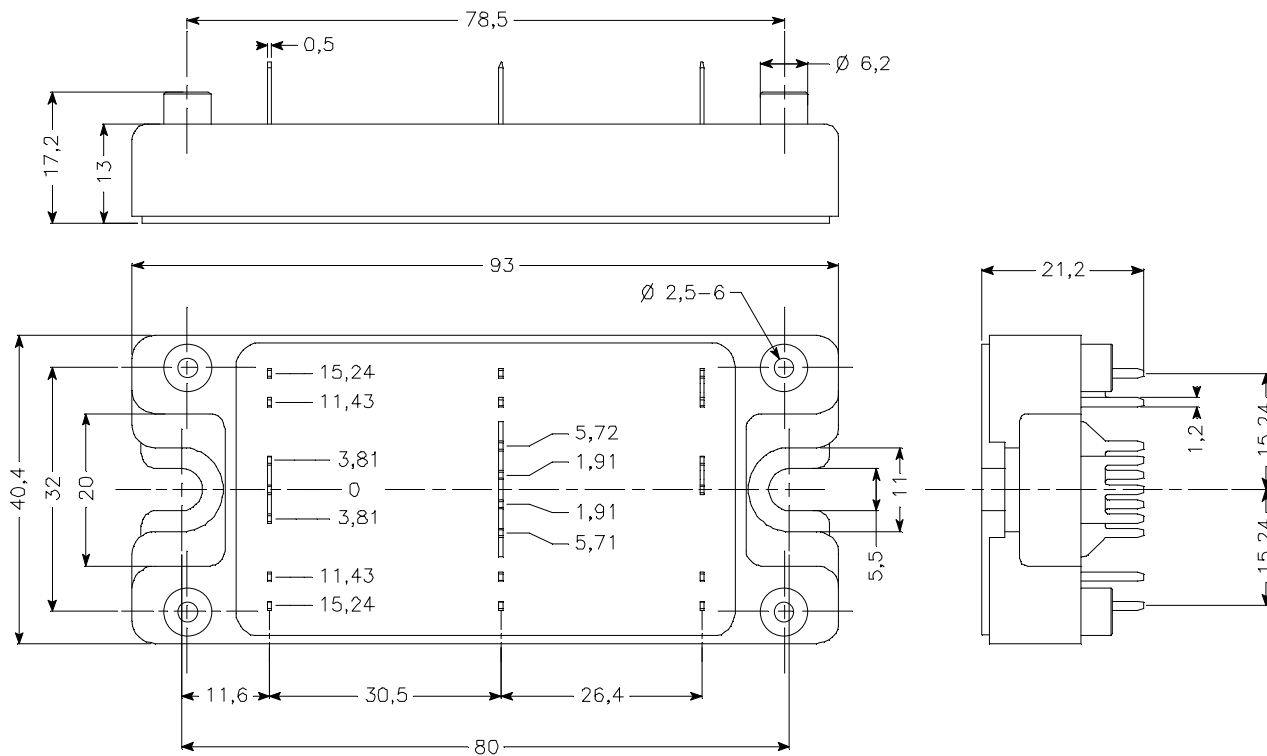

**Typical Performance Curve**

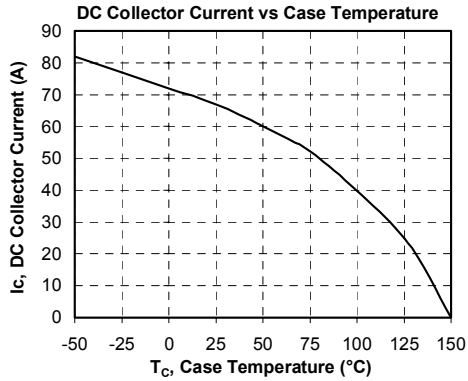
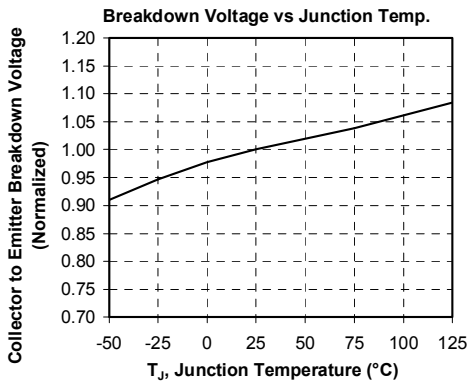
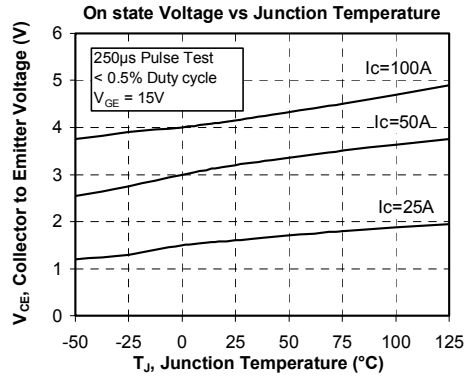
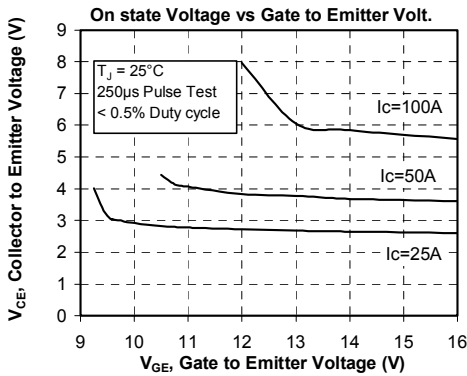
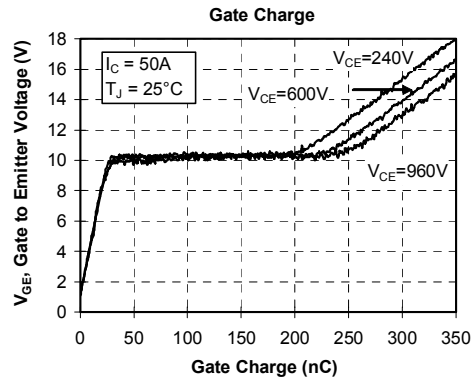
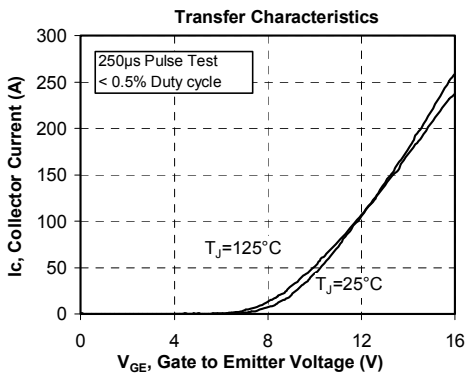
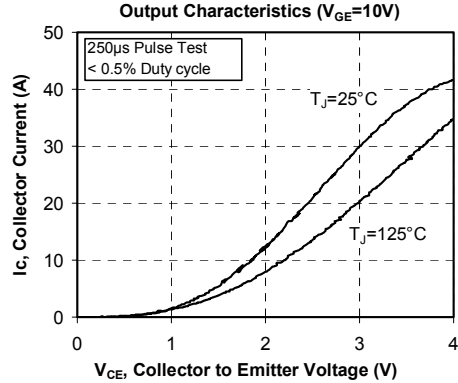
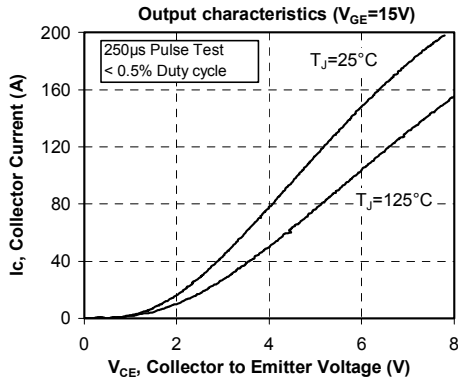

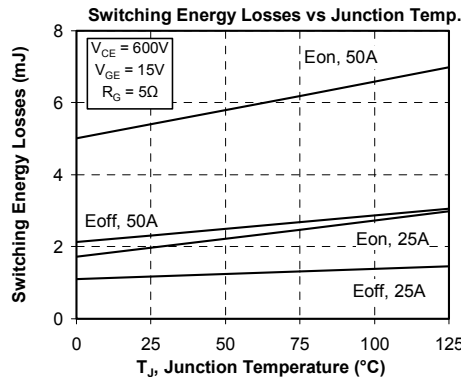
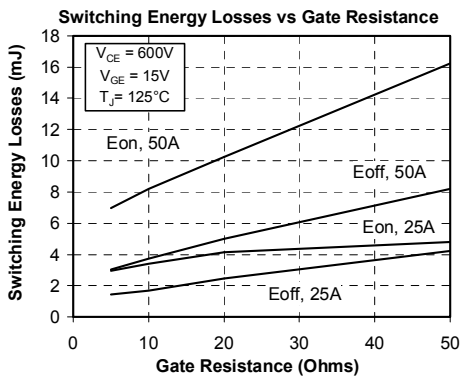
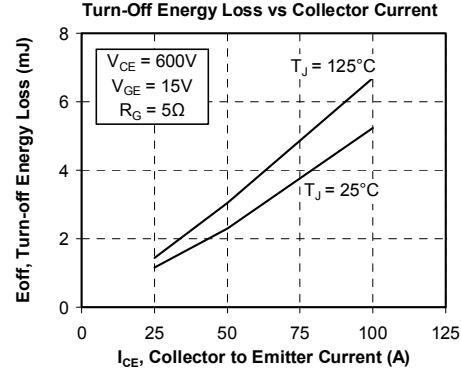
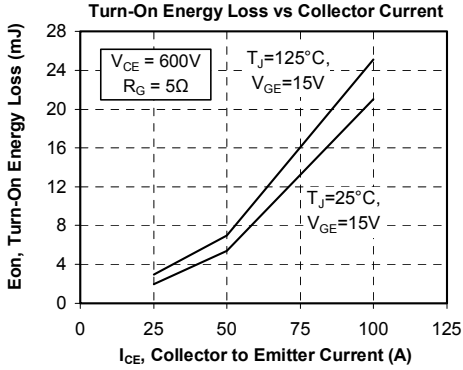
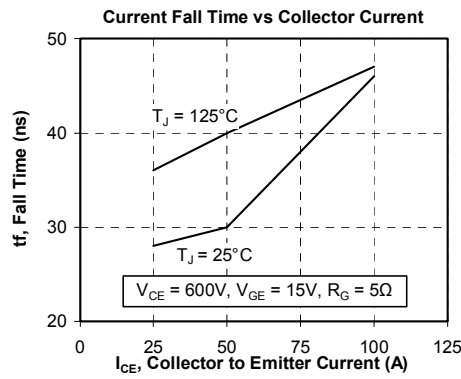
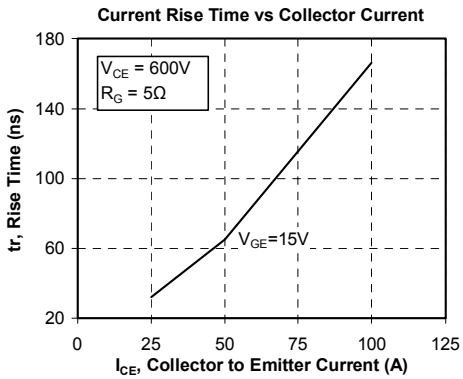
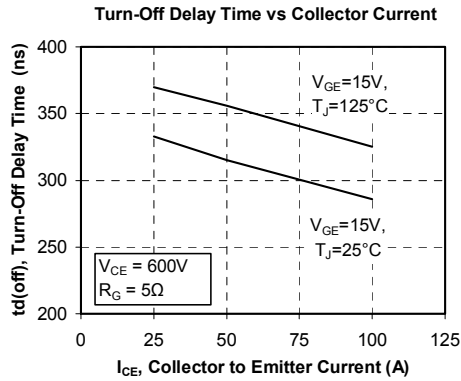
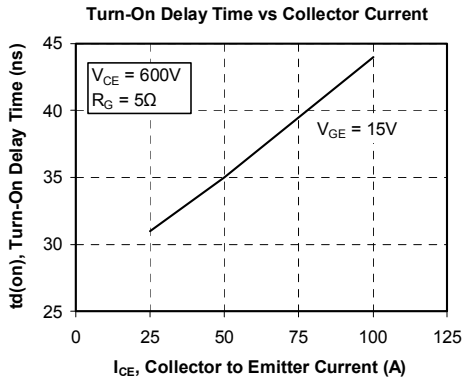

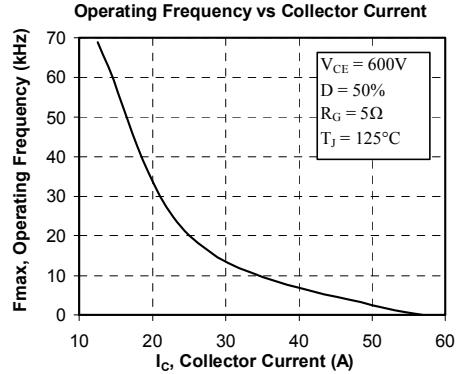
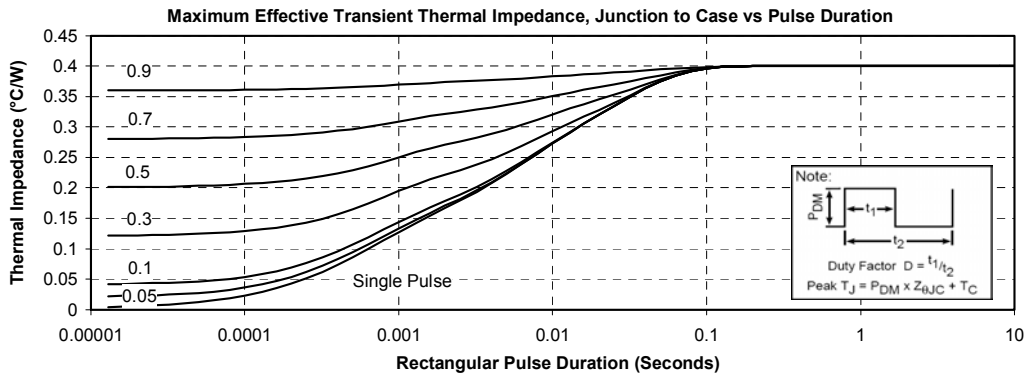
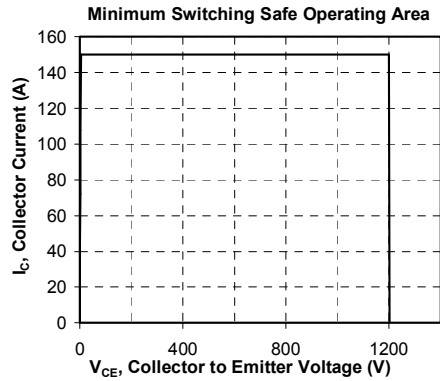
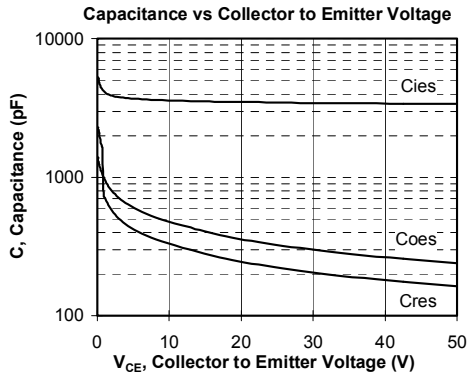

APT reserves the right to change, without notice, the specifications and information contained herein

APT's products are covered by one or more of U.S patents 4,895,810 5,045,903 5,089,434 5,182,234 5,019,522 5,262,336 6,503,786 5,256,583 4,748,103 5,283,202 5,231,474 5,434,095 5,528,058 and foreign patents. U.S and Foreign patents pending. All Rights Reserved.