

Input Voltage: 480

Output Voltage: 12

Product Features:

- Built to order FAST in 1 week
- 10 Year Warranty - Guaranteed to Last.
- Copper Windings - Standard on all units.
- 130°C Insulation class. 80°C temperature rise (25-1000 VA models).
- 155°C Insulation class. 100°C temperature rise (1500-7500 VA models).
- Easy Wiring - Solid terminals with combination screw connections.
- Clear Terminals Marking - Identified with additive polarity markings.
- Versatile - Models with multi-voltage primary and secondary increase applications possible.
- Silicon Steel Lamination - Minimize core losses and increase efficiency.
- Excellent Regulation - Designs incorporate precision wound coils layers and exceed NEMA requirements.
- High Efficiency and Heat Dissipation - Every coil is precision bobbin-wound .
- Versatile Mounting - Vertically or horizontally.
- CSA Certified & UL Listed
- CE verified up to and including 5000 VA.



TEMCo Industrial Control Transformers are used to convert all standard international voltages. Many models are dual frequency rated for 50 and 60 Hz. TEMCo's transformers are built to last, guaranteed! That's why we back these with a decade long warranty.

Our industrial control transformers change supply voltages for the operation of components such as contactors, solenoids, relays, and timers. They accommodate momentary current inrush produced when electromagnetic components are energized without compromising secondary voltage stability. Maximum Safety is assured through the secondary control circuit which is isolated from the primary line circuit.

Voltage regulation of TEMCo Industrial Control Transformers exceeds standards recommended by the National Electrical Manufacturers Association. Secondary circuit voltage drop between no-load and momentary overload remains exceptionally low, maintaining excellent voltage regulation.

TEMCo has the capability to wind any custom control transformer with no penalty for small quantities. Please call us with your requirements for a Fast Turnaround Quote.

Corporate Headquarters: TEMCo - Tower Electric Motor Company 41484 Christy Street Fremont, CA 94538
Inside USA: (877) 474-8209 **International:** (510) 490-2187 **Fax:** (510) 490-1507 www.temcoindustrialpower.com

Specifications may vary slightly from the information provided. For certified drawings and information, please contact a TEMCo representative.



TEMCo Control Transformer - Specifications

TT3042 - TT3056

Input Voltage:	480
Output Voltage:	12
Subtype:	Control
Phase:	Single
Frequency (Hz):	60
VA:	25 to 7500 VA (25, 50 , 100, 150, 200, 250, 350, 500, 750, 1000, 1500, 2000, 3000, 5000, 7500)
K Rating:	1
Primary configuration:	One Winding
Secondary configuration:	One Winding
Reverse connectable:	No
Winding material:	Copper
Electrostatic shielded:	No
Temperature rise:	80°C (25 to 1000 VA) 100°C (1500 to 7500 VA)
Insulation system:	130°C (25 to 1000 VA) 155°C (1500 to 7500 VA)
Enclosure raing:	Open
Construction style:	Open - Core & Coil
Mounting type:	Base/Panel
Connection type:	Screw Terminals
Cooling:	Air/Dry
UL Listed:	Yes
CSA Approved:	Yes
Other agency approvals:	CE Verified (up to and including 5000 VA)
Sound level:	Less than 40 db
Warranty:	10 Years

Corporate Headquarters: TEMCo - Tower Electric Motor Company 41484 Christy Street Fremont, CA 94538
Inside USA: (877) 474-8209 **International:** (510) 490-2187 **Fax:** (510) 490-1507 www.temcoindustrialpower.com

Specifications may vary slightly from the information provided. For certified drawings and information, please contact a TEMCo representative.



TEMCo Control Transformer - Dimensions & Weights

TT3042 - TT3056

Input Voltage: 480

Output Voltage: 12

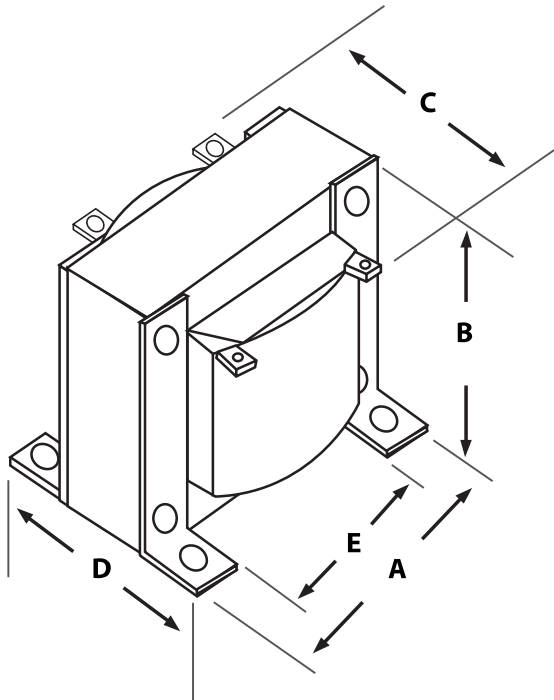

Dimensions (in inches)

Part #	VA	A	B	C	D	E	Mounting Holes	Weight (lbs.)
TT3042	25	3	2.5	2.77	1.98	2.5	0.21 x 0.625	1.25
TT3043	50	3	2.5	3	2.25	2.5	0.21 x 0.625	2.25
TT3044	100	3	2.5	3.27	2.5	2.5	0.21 x 0.625	2.75
TT3045	150	3.75	3.13	4.02	3	3.13	0.21 x 0.625	5.75
TT3046	200	3.75	3.13	4.59	3.25	3.13	0.21 x 0.625	6
TT3047	250	4.5	3.75	4.15	2.75	3.75	0.21 x 0.625	7.5
TT3048	350	4.5	3.75	5.2	3.75	3.75	0.21 x 0.625	11
TT3049	500	5.25	4.38	4.95	3.12	4.38	0.28 x 0.56	12.5
TT3050	750	5.25	4.38	6	4.12	4.38	0.28 x 0.56	19
TT3051	1000	5.25	4.38	6.7	5.12	4.38	0.28 x 0.56	25
TT3052	1500	7.5	6.25	6.75	3.5	6.75	0.31 x 0.688	36
TT3053	2000	7.5	6.25	7.75	4.5	6.75	0.31 x 0.688	39
TT3054	3000	7.5	6.25	9.75	6.5	6.75	0.31 x 0.688	59
TT3055	5000	9	8	9.75	6.5	8	0.31 x 0.688	91
TT3056	7500	9	8	11.75	8.5	8	0.31 x 0.688	115

Note: All dimensions are +/- 0.06 in. except for dimension "C," which is +/- 0.25 in.

Corporate Headquarters: TEMCo - Tower Electric Motor Company 41484 Christy Street Fremont, CA 94538
Inside USA: (877) 474-8209 **International:** (510) 490-2187 **Fax:** (510) 490-1507 www.temcoindustrialpower.com

Specifications may vary slightly from the information provided. For certified drawings and information, please contact a TEMCo representative.



TEMCo Control Transformer - Wiring Diagram

TT3042 - TT3056

Input Voltage: 480

Output Voltage: 12

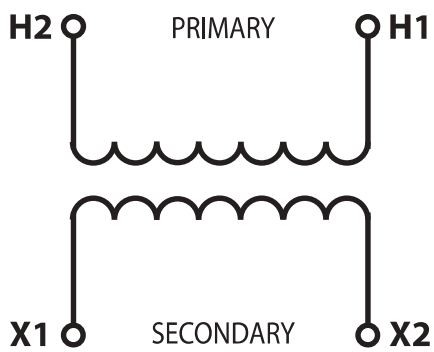

Corporate Headquarters: TEMCo - Tower Electric Motor Company 41484 Christy Street Fremont, CA 94538
Inside USA: (877) 474-8209 **International:** (510) 490-2187 **Fax:** (510) 490-1507 www.temcoindustrialpower.com

Specifications may vary slightly from the information provided. For certified drawings and information, please contact a TEMCo representative.