



PRELIMINARY

CMOS Crystal Clock Generators

CGS3311/CGS3312/CGS3313/CGS3314/CGS3315/ CGS3316/CGS3317/CGS3318/CGS3319

General Description

These devices are designed for Clock Generation and Support (CGSTM) applications up to 110 MHz. The CGS331x series of devices are crystal controlled CMOS oscillators requiring a minimum of external components. The 331x devices provide selectable output divide ratio (and selectable crystal drive level). The circuit is designed to operate over a wide frequency range using fundamental mode or overtone crystals.

- Crystal frequency operation range:
fundamental: 10 MHz to 100 MHz typical
3rd or 5th overtone: 10 MHz to 85 MHz
- Programmable oscillator drive
- Selectable fast output edge rates
- Output symmetry circuit to adjust 50% duty cycle point between CMOS and TTL levels
- Output current drive of 48 mA for I_{OL}/I_{OH}
- FACT™ CMOS output levels
- Output has high speed short circuit protection
- Basic oscillator type: Pierce
- Hysteresis inputs to improve noise margin

Features

- National's CGSTM family of devices for high frequency clock source applications

Block Diagrams

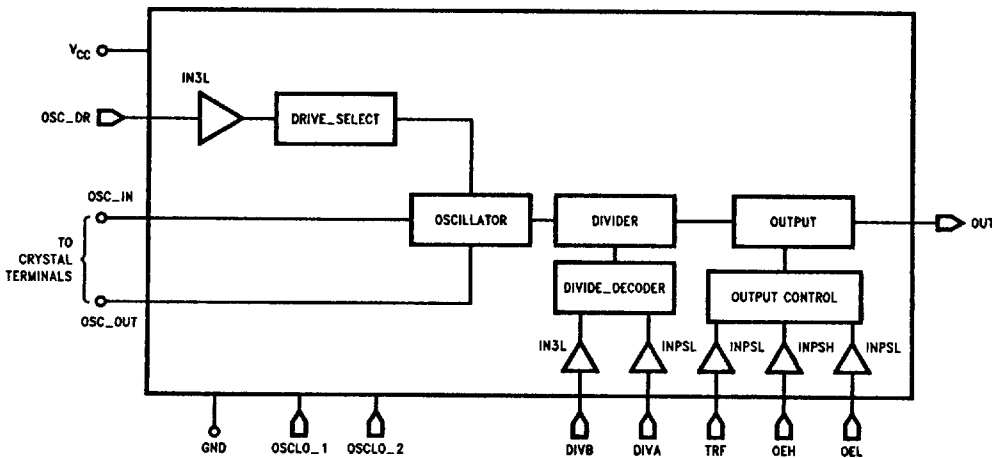

Note: Pin numbers vary for each device

TL/F/10980-1

CGS3311/CGS3312/CGS3313/CGS3314/CGS3315/CGS3316/CGS3317/CGS3318/CGS3319

Block Diagrams (Continued)

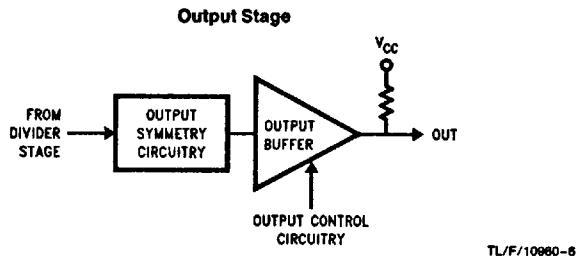
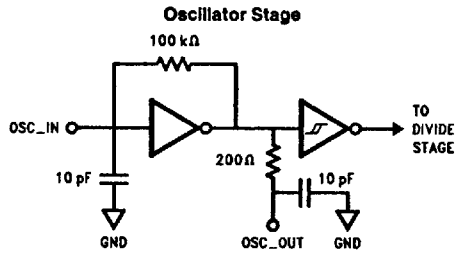
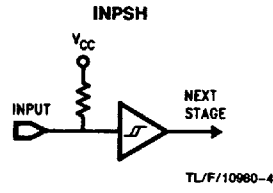
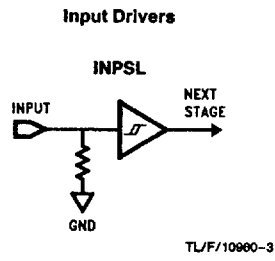
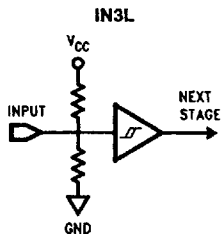

CGS3311/CGS3312/CGS3313/CGS3314/CGS3315/CGS3316/CGS3317/CGS3318/CGS3319

CGS3311/CGS3312/CGS3313/CGS3314/CGS3315/CGS3316/CGS3317/CGS3318/CGS3319

Functional Description

Summary of Device Options

Device	Divide	Enable	Drive	Output Rise/ Fall Time (ns)
3311	1, 2, 4	OEH	L, M, H	2, 4
3312	1, 2, 4	OEH	H	2, 4
3313	8, 16, 32	OEH	H	4
3314	8, 16, 32	OEH	L, M, H	4
3315	1, 2, 4	OEL	H	1, 2
3316	4	OEH	H	4
3317	32	OEH	H	4
3318	1, 2, 4	OEH	H	1, 2
3319	1, 2, 4	OEL	L, M, H	2, 4

Each drive has one output with the choices of selecting frequency divide, output enable, crystal drive and output rise and fall time. Crystal drive options are:
 L = Low Drive
 M = Medium Drive
 H = High Drive

Pin Descriptions

Note: Pin out varies for each device.

OSC_IN Input to Oscillator Inverter. The output of the crystal would be connected here.

OSC_OUT Resistive Buffered Output of the Oscillator Inverter

OSC_DR 3 Level input pin that selects Oscillator Drive Level

DIVA Input used to select Binary Divide-by Option. This pin has CMOS compatible input levels.

DIVB 3 Level input used to select Binary Divide-by value.

OEH Active High TRI-STATE® enable pin. This pin pulls to a high value when left floating and TRI-STATES the output when forced low. This pin has TTL compatible input levels.

OEL Active Low TRI-STATE enable pin. This pin pulls to a low value when left floating and TRI-STATES the output when forced high. This pin has TTL compatible input levels.

TRF Rise and Fall time override pin. Available only for die form.

OUT This pin is the main clock output on the device.

OSCLO_1 The Oscillator Low pin is the ground for the Oscillator.

OSCLO_2 This pin is the same signal as OSCLO_1. It has been provided as an alternate connection for OSCLO_1 for hybrid assemblies.

VCC The power pin for the chip.

GND The ground pin for all sections of the circuitry except the oscillator and oscillator related circuitry.

Connection Diagrams

Pin Assignment for SOIC

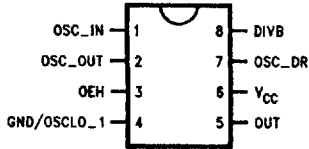

(A) 3311

TL/F/10980-7

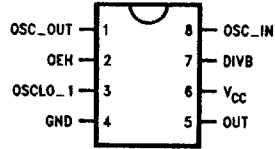

(B) 3312

TL/F/10980-8

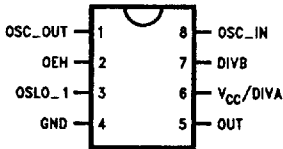

(C) 3313

TL/F/10980-9

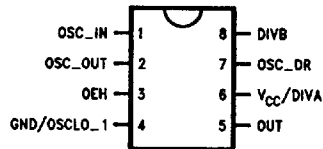

(D) 3314

TL/F/10980-10

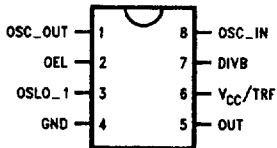

(E) 3315

TL/F/10980-11

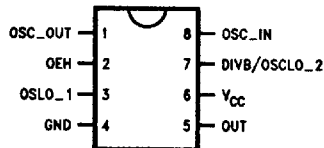

(F) 3316

TL/F/10980-12

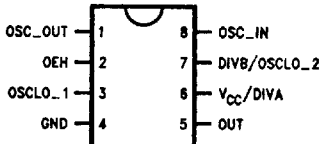

(G) 3317

TL/F/10980-13

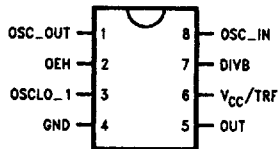

(H) 3318

TL/F/10980-14

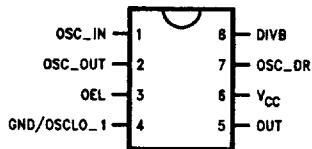

(I) 3319

TL/F/10980-15

CGS3311/CGS3312/CGS3313/CGS3314/CGS3315/CGS3316/CGS3317/CGS3318/CGS3319

CGS3311/CGS3312/CGS3313/CGS3314/CGS3315/CGS3316/CGS3317/CGS3318/CGS3319

Truth Tables

Division Selection

DIVB	DIVA	OEL	OEH	Divider Output
F	0/F	X	X	Divide-by 1
1	0/F	0	1	Divide-by 2
0	0/F	0	1	Divide-by 4
F	1	0	1	Divide-by 8
1	1	0	1	Divide-by 16
0	1	0	1	Divide-by 32
X	X	1	X	Output Reset High at Re-enable
X	X	X	0	Output Reset High at Re-enable

Note: Actual value of the floating OSC_DR and DIVB input is V_{CC}/2

Rise and Fall Time Selection

OSC_DR	DIV	TRF	Rise/Fall Time (ns)
F	N	0/F	2
F	N	1	less than 2
F	Y	0/F	4
F	Y	1	2
0, 1	X	0/F	4
0, 1	X	1	2

Drive Selection

OSC_DR	Drive
0	Low
1	Medium
F	High

Note: Where "F" indicates floating the input.

Absolute Maximum Ratings (Note 1)

If Military/Aerospace specified devices are required, please contact the National Semiconductor Sales Office/Distributors for availability and specifications.

Supply Voltage (V _{CC})	-0.5V to 7.0V
DC Input Voltage Diode Current (I _{IK})	± 9mA
DC Input Voltage (V _I)	-0.5V to 7.0V
DC Output Diode Current (I _{OK})	± 20 mA
DC Output Voltage (V _O)	-0.5V to V _{CC} + 0.5V
DC Output Source or Sink Current (I _O)	± 70 mA
Storage Temperature (T _{STG})	-55°C to +150°C
Junction Temperature (T _J)	
SOIC	140°C/W

Recommended Operating Conditions

Supply Voltage (V _{CC})	4.5V to 5.5V
Input Voltage (V _I)	0V to 5.5V
Output Voltage (V _O)	0V to V _{CC} V
Operating Temperature (T _A)	-40°C to +85°C

Note: The Absolute Maximum Ratings are those values beyond which the safety of the device cannot be guaranteed. The device should not be operated at these limits. The parametric values defined in the DC and AC Electrical Characteristics tables are not guaranteed at the absolute maximum ratings. The Recommended Operating Conditions will define the conditions for actual device operation.

DC Electrical Characteristics

Symbol	Parameter	V _{CC} (V)	CGS3311 to 3319						Units	Conditions	
			T _A = +25°C		T _A = -40°C to +85°C		T _A = -55°C to +125°C				
			Guaranteed Limits								
			Typ	Min	Max	Min	Max	Min			Max
V _{IHTTL}	Minimum High Level Input Voltage. TTL Level Inputs (OE _H , OE _L)	4.5		2.0		2.0				V	
		5.5		2.0		2.0					
V _{ILTTL}	Maximum Low Level Input Voltage. TTL Level Inputs (OE _H , OE _L)	4.5			0.8		0.8			V	
		5.5			0.8		0.8				
V _{IHCMOS}	Minimum High Level Input Voltage. CMOS Level Inputs (DIVA)	4.5		3.15		3.15				V	
		5.5		3.85		3.85					
V _{ILCMOS}	Maximum Low Level Input Voltage. CMOS Level Inputs (DIVA)	4.5			1.35		1.35			V	
		5.5			1.65		1.65				
V _{IN3L_H}	Minimum Logic 1 Input for Three Level Input (DIVB, OSC_DR)	4.5		4.05		4.05				V	
		5.5		4.95		4.95					
V _{IN3L_1/2}	Minimum Logic 1/2 Input for Three Level Input (DIVB, OSC_DR)	4.5		1.8	2.7	1.8	2.7			V	
		5.5		2.2	3.3	2.2	3.3				
V _{IN3L_L}	Maximum Logic 0 Input Level Three Level Input (DIVB, OSC_DR)	4.5			0.45		0.45			V	
		5.5			0.45		0.45				
V _{OH}	Minimum High Level Output Voltage	4.5	4.49	4.40		4.40				V	I _{OUT} = -50 μA
		5.5	5.49	5.40		5.40					
		4.5		3.86		3.76					I _{OH} = -48 mA V _{IN} = V _{IH} or V _{IH}
		5.5		4.86		4.76					

CGS3311/CGS3312/CGS3313/CGS3314/CGS3315/CGS3316/CGS3317/CGS3318/CGS3319



CGS3311/CGS3312/CGS3313/CGS3314/CGS3315/CGS3316/CGS3317/CGS3318/CGS3319

DC Electrical Characteristics (Continued)											
Symbol	Parameter	V _{CC} (V)	CGS3311 to 3319						Units	Conditions	
			T _A = +25°C		T _A = -40°C to +85°C		T _A = -55°C to +125°C				
			Typ	Guaranteed Limits							
				Min	Max	Min	Max	Min			Max
V _{OL}	Minimum Low Level Output Voltage	4.5	0.001		0.1		0.1		V	I _{OUT} = 50 μA	
		5.5	0.001		0.1		0.1				
		4.5			0.44		0.44				
		5.5			0.44		0.44			I _{OL} = +48 mA V _{IN} = V _{IL} or V _{IH}	
I _{HRES}	Input Current for Pins DIVB, OSC_DR, and DIVA (Input is Logic High)	5.5		220	360	200	380		μA	V _{IN} = 5.5V	
I _{LRRES}	Input Current for Pins DIVB, OSC_DR, and DIVA (Input is Logic Low)	5.5		-220	-360	-200	-380		μA	V _{IN} = 0.0V	
I _{HENAB}	Input Current for Enable Pin OEL	5.5		90	160	85	175		μA	V _{IN} = 5.5V	
I _{LENAB}	Input Current for Enable pin OEH	5.5		-90	-160	-85	-175		μA	V _{IN} = 0.0V	
I _{HOSC}	Input Current for OSC_IN pin (Indicates Bias Resistance)	5.5		20	100	20	125		μA	V _{IN} = 5.5V	
I _{LOSC}	Input Current for OSC_IN pin (Indicates Bias Resistance)	5.5		-20	-100	-20	-125		μA	V _{IN} = 0.0V	
I _{OZH}	Output Disabled Current (Output High)	4.5			3.0		5.0		μA	V _{OUT} = V _{CC}	
		5.5			3.0		5.0				
I _{OZL}	Output Disabled Current (Output Low)	4.5			-140		-150		μA	V _{OUT} = 0.0V	
		5.5			-170		-180				
I _{OLD}	Minimum Dynamic Output Current	5.5		75		75			mA	V _{OLD} = 1.65V	
I _{OHD}	Minimum Dynamic Output Current	5.5		-75		-75			mA	V _{OHD} = 3.85V	
I _{CCOSC_L}	Additional I _{CC} with OSC_IN Floating. Low Drive Mode	4.5		0.6		0.6			mA	OSC_IN = Float	
		5.5			6.5		6.5				
I _{CCOSC_M}	Additional I _{CC} with OSC_IN Floating. Low Drive Mode	4.5		1.7		1.7			mA	OSC_IN = Float	
		5.5			12.4		12.4				
I _{CCOSC_H}	Additional I _{CC} with OSC_IN Floating. Low Drive Mode	4.5		5.5		5.5			mA	OSC_IN = Float	
		5.5			31.5		31.5				
I _{CC_T}	Additional Maximum I _{CC} per Input (OEH, OEL Pins)	5.5			1.5		1.5		mA	V _{IN} = V _{CC} - 2.1V	
I _{CC_3L}	Additional Maximum I _{CC} per Input (DIVB, OSC_DR Inputs)	5.5			1.5		1.5		mA	DIVB, OSC_DR Inputs Equal to V _{CC} /2	

AC Electrical Characteristics

Over recommended operating free air temperature range. All typical values are measured at $V_{CC} = 5V$, $T_A = 25^\circ C$.

Symbol	Parameter	V _{CC} * (V)	CGS331X						Units
			T _A = -40°C to +85°C C _L = 50 pF			T _A = -55°C to +125°C C _L = 50 pF			
			Min	Typ	Max	Min	Typ	Max	
f _{MAX}	Frequency Maximum	5.0	100						MHz
t _{PZH}	Output High Enable Time	5.0	1.0		31.5				ns
t _{PZL}	Output Low Enable Time	5.0	1.0		28.0				ns
t _{PHZ}	Output High Disable Time	5.0	1.0		21.5				ns
t _{PLZ}	Output Low Disable Time	5.0	1.0		16.0				ns
t _{rise} , t _{fall}	Rise/Fall Time (30 pF, 20% to 80%)	5.0		4.0					ns

* Voltage Range 5.0 is 5.0V ± 0.5V

CGS3311/CGS3312/CGS3313/CGS3314/CGS3315/CGS3316/CGS3317/CGS3318/CGS3319