



# Octal, 12-/16-Bit DAC, I<sup>2</sup>C<sup>®</sup>, 5ppm/°C On-Chip Reference in 4mm X 4mm LFCSP

Preliminary Technical Data

## AD5629R/AD5669R

### FEATURES

Low power, smallest-pin-compatible octal DACs

AD5669R: 16 bits

AD5629R: 12 bits

4mm X 4mm 16-lead LFCSP and 16-lead TSSOP

User selectable on-chip 1.25 V/2.5 V, 5 ppm/°C reference

Power down to 400 nA @ 5 V, 200 nA @ 3 V

2.7 V to 5.5 V power supply

Guaranteed monotonic by design

Power-on reset to zero scale or midscale

3 power-down functions

Hardware LDAC and CLR functions

I<sup>2</sup>C-compatible serial interface supports standard (100 kHz) and fast (400 kHz) modes

### APPLICATIONS

Process control

Data acquisition systems

Portable battery-powered instruments

Digital gain and offset adjustment

Programmable voltage and current sources

### GENERAL DESCRIPTION

The AD5629R/AD5669R devices are low power, octal, 12-/16-bit, buffered voltage-output DACs. All devices operate from a single 2.7 V to 5.5 V supply and are guaranteed monotonic by design.

The AD5629R/AD5669R has an on-chip reference with an internal gain of 2. The AD5629R/AD5669R has a user selectable 1.25 V 5 ppm/°C reference, giving a full-scale output range of 2.5 V or a 2.5 V 5 ppm/°C reference, giving a full-scale output range of 5 V depending on the option selected. The on-chip reference is off at power-up, allowing the use of an external reference. The internal reference is enabled via a software write. The AD5669/AD5629 require an external reference voltage to set the output range of the DAC.

The part incorporates a power-on reset circuit that ensures that the DAC output powers up to 0 V (AD5629R/AD5669R) or midscale

(AD5669R-3) and remains powered up at this level until a valid write takes place. The part contains a power-down feature that reduces the current consumption of the device to 400 nA at 5 V and provides software-selectable output loads while in power-down mode for any or all DAC channels.

### FUNCTIONAL BLOCK DIAGRAM

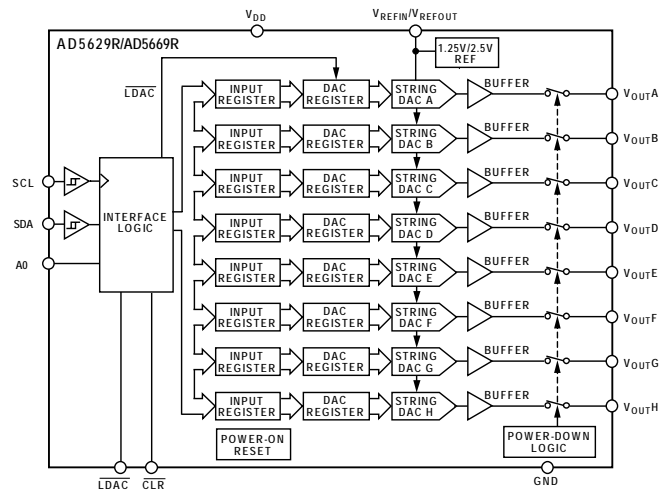

Figure 1

### PRODUCT HIGHLIGHTS

1. Octal, 12-/16-bit DAC.
2. On-chip 1.25 V/2.5 V, 5 ppm/°C reference.
3. Available in 16-lead LFCSP/16-lead TSSOP.
4. Power-on reset to 0 V or midscale.
5. Power-down capability. When powered down, the DAC typically consumes 200 nA at 3 V and 400 nA at 5 V.

### Rev. PrA

Information furnished by Analog Devices is believed to be accurate and reliable. However, no responsibility is assumed by Analog Devices for its use, nor for any infringements of patents or other rights of third parties that may result from its use. Specifications subject to change without notice. No license is granted by implication or otherwise under any patent or patent rights of Analog Devices. Trademarks and registered trademarks are the property of their respective owners.

## TABLE OF CONTENTS

Features .....	1	Resistor String.....	23
Applications.....	1	Internal Reference .....	23
General Description .....	1	Output Amplifier.....	24
Functional Block Diagram .....	1	Serial Interface .....	24
Product Highlights .....	1	Write Operation.....	24
Revision History .....	2	Read Operation.....	24
Specifications.....	3	Input Shift Register .....	27
AC Characteristics.....	7	Internal Reference Register .....	27
I2C Timing Characteristics.....	8	Power-On Reset .....	27
Absolute Maximum Ratings.....	10	Power-Down Modes .....	27
ESD Caution.....	10	Clear Code Register .....	28
Pin Configurations and Function Descriptions .....	11	$\overline{\text{LDAC}}$ Function .....	30
Typical Performance Characteristics .....	12	Power Supply Bypassing and Grounding.....	30
Terminology .....	21	Outline Dimensions .....	32
Theory of Operation .....	23	AD5629R Ordering Guide.....	33
D/A Section .....	23	AD5669R Ordering Guide.....	33

## REVISION HISTORY

## SPECIFICATIONS

$V_{DD} = 4.5\text{ V to }5.5\text{ V}$ ,  $R_L = 2\text{ k}\Omega$  to GND,  $C_L = 200\text{ pF}$  to GND,  $V_{REFIN} = V_{DD}$ . All specifications  $T_{MIN}$  to  $T_{MAX}$ , unless otherwise noted.

Table 1.

Parameter	A Grade <sup>1</sup>			B Grade <sup>1</sup>			Unit	Conditions/Comments
	Min	Typ	Max	Min	Typ	Max		
STATIC PERFORMANCE <sup>2</sup>								
AD5629R								
Resolution	12			12			Bits	
Relative Accuracy		±0.5	±2		±0.5	±1	LSB	See Figure 5
Differential Nonlinearity			±0.25			±0.25	LSB	Guaranteed monotonic by design (see Figure 7)
AD5669R								
Resolution	16			16			Bits	
Relative Accuracy		±8	±32		±8	±16	LSB	See Figure 4
Differential Nonlinearity			±1			±1	LSB	Guaranteed monotonic by design (see Figure 6)
Zero-Code Error		1	9		1	9	mV	All 0s loaded to DAC register (see Figure 19)
Zero-Code Error Drift		±2			±2		μV/°C	
Full-Scale Error		-0.2	-1		-0.2	-1	% FSR	All 1s loaded to DAC register (see Figure 21)
Gain Error			±1			±1	% FSR	
Gain Temperature Coefficient		±2.5			±2.5		ppm	Of FSR/°C
Offset Error		±1	±9		±1	±9	mV	
DC Power Supply Rejection Ratio		-80			-80		dB	$V_{DD} \pm 10\%$
DC Crosstalk (External Reference)		10			10		μV	Due to full-scale output change, $R_L = 2\text{ k}\Omega$ to GND or $V_{DD}$
		5			5		μV/mA	Due to load current change
		10			10		μV	Due to powering down (per channel)
DC Crosstalk (Internal Reference)		25			25		μV	Due to full-scale output change, $R_L = 2\text{ k}\Omega$ to GND or $V_{DD}$
		10			10		μV/mA	Due to load current change
OUTPUT CHARACTERISTICS <sup>3</sup>								
Output Voltage Range	0		$V_{DD}$	0		$V_{DD}$	V	
Capacitive Load Stability		2			2		nF	$R_L = \infty$
		10			10		nF	$R_L = 2\text{ k}\Omega$
DC Output Impedance		0.5			0.5		Ω	
Short-Circuit Current		30			30		mA	$V_{DD} = 5\text{ V}$
Power-Up Time		4			4		μs	Coming out of power-down mode, $V_{DD} = 5\text{ V}$
REFERENCE INPUTS								
Reference Current		40	50		40	50	μA	$V_{REF} = V_{DD} = 5.5\text{ V}$ (per DAC channel)
Reference Input Range	0		$V_{DD}$	0		$V_{DD}$	V	
Reference Input Impedance		14.6			14.6		kΩ	
REFERENCE OUTPUT(1.25V)								
Output Voltage	1.247		1.253	1.247		1.253	μA	At ambient
Reference Input Range		±5			±5	±10	ppm/°C	
Output Impedance		7.5			7.5		kΩ	
REFERENCE OUTPUT(2.5V)								
Output Voltage	2.495		2.505	2.495		2.505	μA	At ambient
Reference Input Range		±5			±5	±10	ppm/°C	
Output Impedance		7.5			7.5		kΩ	
LOGIC INPUTS <sup>3</sup>								
Input Current			±3			±3	μA	All digital inputs

Parameter	A Grade <sup>1</sup>			B Grade <sup>1</sup>			Unit	Conditions/Comments
	Min	Typ	Max	Min	Typ	Max		
Input Low Voltage, $V_{INL}$			0.8			0.8	V	$V_{DD} = 5\text{ V}$
Input High Voltage, $V_{INH}$	2			2			V	$V_{DD} = 5\text{ V}$
Pin Capacitance		3			3		pF	
POWER REQUIREMENTS								
$V_{DD}$	4.5		5.5	4.5		5.5	V	All digital inputs at 0 or $V_{DD}$ , DAC active, excludes load current
$I_{DD}$ (Normal Mode) <sup>4</sup>								$V_{IH} = V_{DD}$ and $V_{IL} = \text{GND}$
$V_{DD} = 4.5\text{ V to }5.5\text{ V}$		1.3	1.8		1.3	1.8	mA	Internal reference off
$V_{DD} = 4.5\text{ V to }5.5\text{ V}$		2	2.5		2	2.5	mA	Internal reference on
$I_{DD}$ (All Power-Down Modes) <sup>5</sup>								
$V_{DD} = 4.5\text{ V to }5.5\text{ V}$		0.4	1		0.4	1	$\mu\text{A}$	$V_{IH} = V_{DD}$ and $V_{IL} = \text{GND}$

<sup>1</sup> Temperature range is  $-40^{\circ}\text{C}$  to  $+105^{\circ}\text{C}$ , typical at  $25^{\circ}\text{C}$ .

<sup>2</sup> Linearity calculated using a reduced code range of AD5629R (Code 32 to Code 4064) and AD5669R (Code 512 to 65,024). Output unloaded.

<sup>3</sup> Guaranteed by design and characterization; not production tested.

<sup>4</sup> Interface inactive. All DACs active. DAC outputs unloaded.

<sup>5</sup> All eight DACs powered down.

$V_{DD} = 2.7\text{ V to }3.6\text{ V}$ ,  $R_L = 2\text{ k}\Omega\text{ to GND}$ ,  $C_L = 200\text{ pF to GND}$ ,  $V_{REFIN} = V_{DD}$ . All specifications  $T_{MIN}$  to  $T_{MAX}$ , unless otherwise noted.

Table 2.

Parameter	A Grade <sup>1</sup>			B Grade <sup>1</sup>			Unit	Conditions/Comments
	Min	Typ	Max	Min	Typ	Max		
STATIC PERFORMANCE <sup>2</sup>								
AD5629R								
Resolution	12			12			Bits	
Relative Accuracy		±0.5	±2		±0.5	±1	LSB	See Figure 5
Differential Nonlinearity			±0.25			±0.25	LSB	Guaranteed monotonic by design (see Figure 7)
AD5669R								
Resolution	16			16			Bits	
Relative Accuracy		±8	±32		±8	±16	LSB	See Figure 4
Differential Nonlinearity			±1			±1	LSB	Guaranteed monotonic by design (see Figure 6)
Zero-Code Error		1	9		1	9	mV	All 0s loaded to DAC register (see Figure 19)
Zero-Code Error Drift		±2			±2		μV/°C	
Full-Scale Error		-0.2	-1		-0.2	-1	% FSR	All 1s loaded to DAC register (see Figure 21)
Gain Error			±1			±1	% FSR	
Gain Temperature Coefficient		±2.5			±2.5		ppm	Of FSR/°C
Offset Error		±1	±9		±1	±9	mV	
DC Power Supply Rejection Ratio		-80			-80		dB	$V_{DD} \pm 10\%$
DC Crosstalk (External Reference)		10			10		μV	Due to full-scale output change, $R_L = 2\text{ k}\Omega\text{ to GND or }V_{DD}$
		5			5		μV/mA	Due to load current change
		10			10		μV	Due to powering down (per channel)
DC Crosstalk (Internal Reference)		25			25		μV	Due to full-scale output change, $R_L = 2\text{ k}\Omega\text{ to GND or }V_{DD}$
		10			10		μV/mA	Due to load current change
OUTPUT CHARACTERISTICS <sup>3</sup>								
Output Voltage Range	0		$V_{DD}$	0		$V_{DD}$	V	
Capacitive Load Stability		2			2		nF	$R_L = \infty$
		10			10		nF	$R_L = 2\text{ k}\Omega$
DC Output Impedance		0.5			0.5		Ω	
Short-Circuit Current		30			30		mA	$V_{DD} = 3\text{ V}$
Power-Up Time		4			4		μs	Coming out of power-down mode, $V_{DD} = 3\text{ V}$
REFERENCE INPUTS								
Reference Current		40	50		40	50	μA	$V_{REF} = V_{DD} = 3.6\text{ V}$ (per DAC channel)
Reference Input Range	0		$V_{DD}$	0		$V_{DD}$		
Reference Input Impedance		14.6			14.6		kΩ	
REFERENCE OUTPUT								
Output Voltage	1.247		1.253	1.247		1.253	V	At ambient
AD5629R/AD5669R								
Reference TC <sup>3</sup>		±5			±5	±15	ppm/°C	
Reference Output Impedance		7.5			7.5		kΩ	
LOGIC INPUTS <sup>3</sup>								
Input Current			±3			±3	μA	All digital inputs
Input Low Voltage, $V_{INL}$			0.8			0.8	V	$V_{DD} = 3\text{ V}$
Input High Voltage, $V_{INH}$	2			2			V	$V_{DD} = 3\text{ V}$
Pin Capacitance		3			3		pF	
POWER REQUIREMENTS								
$V_{DD}$	2.7		3.6	2.7		3.6	V	All digital inputs at 0 or $V_{DD}$ ,

Parameter	A Grade <sup>1</sup>			B Grade <sup>1</sup>			Unit	Conditions/Comments
	Min	Typ	Max	Min	Typ	Max		
$I_{DD}$ (Normal Mode) <sup>4</sup>								DAC active, excludes load current
$V_{DD} = 2.7\text{ V to }3.6\text{ V}$		1.2	1.5		1.2	1.5	mA	$V_{IH} = V_{DD}$ and $V_{IL} = \text{GND}$
$V_{DD} = 2.7\text{ V to }3.6\text{ V}$		1.7	2.25		1.7	2.25	mA	Internal reference off
$I_{DD}$ (All Power-Down Modes) <sup>5</sup>								Internal reference on
$V_{DD} = 2.7\text{ V to }3.6\text{ V}$		0.2	1		0.2	1	$\mu\text{A}$	$V_{IH} = V_{DD}$ and $V_{IL} = \text{GND}$

<sup>1</sup> Temperature range is  $-40^{\circ}\text{C}$  to  $+105^{\circ}\text{C}$ , typical at  $25^{\circ}\text{C}$ .

<sup>2</sup> Linearity calculated using a reduced code range of AD5629R (Code 32 to Code 4064) and AD5669R (Code 512 to 65024). Output unloaded.

<sup>3</sup> Guaranteed by design and characterization; not production tested.

<sup>4</sup> Interface inactive. All DACs active. DAC outputs unloaded.

<sup>5</sup> All eight DACs powered down.

**AC CHARACTERISTICS**

$V_{DD} = 2.7\text{ V to }5.5\text{ V}$ ,  $R_L = 2\text{ k}\Omega$  to GND,  $C_L = 200\text{ pF}$  to GND,  $V_{REFIN} = V_{DD}$ . All specifications  $T_{MIN}$  to  $T_{MAX}$ , unless otherwise noted.

**Table 3.**

Parameter <sup>1,2</sup>	Min	Typ	Max	Unit	Conditions/Comments <sup>3</sup>
Output Voltage Settling Time		6	10	$\mu\text{s}$	$\frac{1}{4}$ to $\frac{3}{4}$ scale settling to $\pm 2$ LSB
Slew Rate		1.5		$\text{V}/\mu\text{s}$	
Digital-to-Analog Glitch Impulse		4		$\text{nV}\cdot\text{s}$	1 LSB change around major carry (see Figure 49)
Digital Feedthrough		0.1		$\text{nV}\cdot\text{s}$	
Reference Feedthrough		-90		dB	$V_{REF} = 2\text{ V} \pm 0.1\text{ V p-p}$ , frequency = 10 Hz to 20 MHz
Digital Crosstalk		0.5		$\text{nV}\cdot\text{s}$	
Analog Crosstalk		2.5		$\text{nV}\cdot\text{s}$	
DAC-to-DAC Crosstalk		3		$\text{nV}\cdot\text{s}$	
Multiplying Bandwidth		340		kHz	$V_{REF} = 2\text{ V} \pm 0.2\text{ V p-p}$
Total Harmonic Distortion		-80		dB	$V_{REF} = 2\text{ V} \pm 0.1\text{ V p-p}$ , frequency = 10 kHz
Output Noise Spectral Density		120		$\text{nV}/\sqrt{\text{Hz}}$	DAC code = 0x8400, 1 kHz
		100		$\text{nV}/\sqrt{\text{Hz}}$	DAC code = 0x8400, 10 kHz
Output Noise		15		$\mu\text{V p-p}$	0.1 Hz to 10 Hz

<sup>1</sup> Guaranteed by design and characterization; not production tested.

<sup>2</sup> See the Terminology section.

<sup>3</sup> Temperature range is  $-40^\circ\text{C}$  to  $+105^\circ\text{C}$ , typical at  $25^\circ\text{C}$ .

**I2C TIMING CHARACTERISTICS**

$V_{DD} = 2.7\text{ V to }5.5\text{ V}$ ; all specifications  $T_{MIN}$  to  $T_{MAX}$ ,  $f_{SCL} = 400\text{ kHz}$ , unless otherwise noted.

**Table 4.**

Parameter	Conditions	Min	Max	Unit	Description
$f_{SCL}^1$	Standard mode		100	kHz	Serial clock frequency
	Fast mode		400	kHz	
$t_1$	Standard mode	4		$\mu\text{s}$	$t_{HIGH}$ , SCL high time
	Fast mode	0.6		$\mu\text{s}$	
$t_2$	Standard mode	4.7		$\mu\text{s}$	$t_{LOW}$ , SCL low time
	Fast mode	1.3		$\mu\text{s}$	
$t_3$	Standard mode	250		ns	$t_{SU,DAT}$ , data setup time
	Fast mode	100		ns	
$t_4$	Standard mode	0	3.45	$\mu\text{s}$	$t_{HD,DAT}$ , data hold time
	Fast mode	0	0.9	$\mu\text{s}$	
$t_5$	Standard mode	4.7		$\mu\text{s}$	$t_{SU,STA}$ , setup time for a repeated start condition
	Fast mode	0.6		$\mu\text{s}$	
$t_6$	Standard mode	4		$\mu\text{s}$	$t_{HD,STA}$ , hold time (repeated) start condition
	Fast mode	0.6		$\mu\text{s}$	
$t_7$	Standard mode	4.7		$\mu\text{s}$	$t_{BUF}$ , bus-free time between a stop and a start condition
	Fast mode	1.3		$\mu\text{s}$	
$t_8$	Standard mode	4		$\mu\text{s}$	$t_{SU,STO}$ , setup time for a stop condition
	Fast mode	0.6		$\mu\text{s}$	
$t_9$	Standard mode		1000	ns	$t_{RDA}$ , rise time of SDA signal
	Fast mode		300	ns	
$t_{10}$	Standard mode		300	ns	$t_{FDA}$ , fall time of SDA signal
	Fast mode		300	ns	
$t_{11}$	Standard mode		1000	ns	$t_{RCL}$ , rise time of SCL signal
	Fast mode		300	ns	
$t_{11A}$	Standard mode		1000	ns	$t_{RCL1}$ , rise time of SCL signal after a repeated start condition and after an acknowledge bit
	Fast mode		300	ns	
$t_{12}$	Standard mode		300	ns	$t_{FCL}$ , fall time of SCL signal
	Fast mode		300	ns	
$t_{13}$	Standard mode	10		ns	$\overline{\text{LDAC}}$ pulse width low
	Fast mode	10		ns	
$t_{14}$	Standard mode	300		ns	Falling edge of ninth SCL clock pulse of last byte of a valid write to LDAC falling edge
	Fast mode	300		ns	
$t_{15}$	Standard mode	20		ns	$\overline{\text{CLR}}$ pulse width low
	Fast mode	20		ns	
$t_{sp}^2$	Fast mode	0	50	ns	Pulse width of spike suppressed

<sup>1</sup> The SDA and SCL timing is measured with the input filters enabled. Switching off the input filters improves the transfer rate but has a negative effect on EMC behavior of the part.

<sup>2</sup> Input filtering on the SCL and SDA inputs suppresses noise spikes that are less than 50 ns for fast mode, or less than 10 ns for high speed mode.



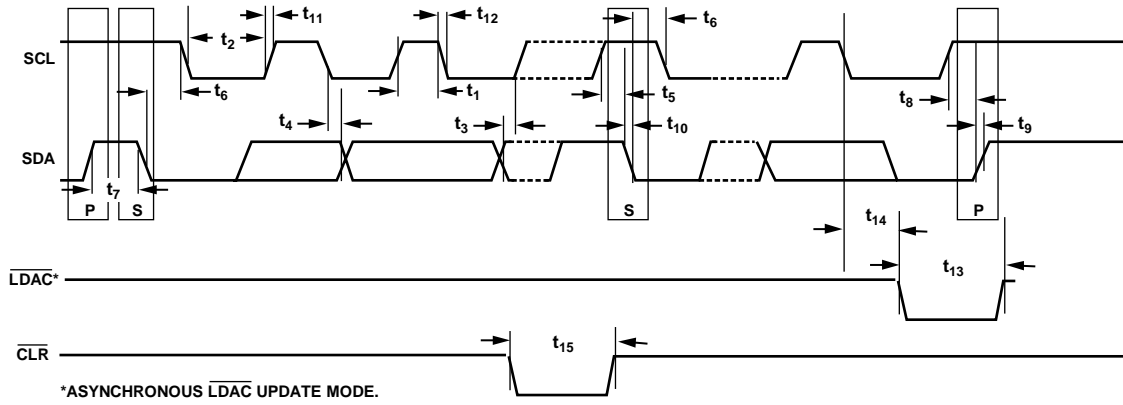

Figure2. Serial Write Operation

08341-003

## ABSOLUTE MAXIMUM RATINGS

$T_A = 25^\circ\text{C}$ , unless otherwise noted.

Table 5.

Parameter	Rating
$V_{DD}$ to GND	-0.3 V to +7 V
Digital Input Voltage to GND	-0.3 V to $V_{DD} + 0.3$ V
$V_{OUT}$ to GND	-0.3 V to $V_{DD} + 0.3$ V
$V_{REFIN}/V_{REFOUT}$ to GND	-0.3 V to $V_{DD} + 0.3$ V
Operating Temperature Range	
Industrial	$-40^\circ\text{C}$ to $+105^\circ\text{C}$
Storage Temperature Range	$-65^\circ\text{C}$ to $+150^\circ\text{C}$
Junction Temperature ( $T_{J\text{ MAX}}$ )	$+150^\circ\text{C}$
TSSOP Package	
Power Dissipation	$(T_{J\text{ MAX}} - T_A)/\theta_{JA}$
$\theta_{JA}$ Thermal Impedance	$150.4^\circ\text{C}/\text{W}$
Reflow Soldering Peak Temperature	
SnPb	$240^\circ\text{C}$
Pb Free	$260^\circ\text{C}$

Stresses above those listed under Absolute Maximum Ratings may cause permanent damage to the device. This is a stress rating only; functional operation of the device at these or any other conditions above those indicated in the operational section of this specification is not implied. Exposure to absolute maximum rating conditions for extended periods may affect device reliability.

### ESD CAUTION

ESD (electrostatic discharge) sensitive device. Electrostatic charges as high as 4000 V readily accumulate on the human body and test equipment and can discharge without detection. Although this product features proprietary ESD protection circuitry, permanent damage may occur on devices subjected to high energy electrostatic discharges. Therefore, proper ESD precautions are recommended to avoid performance degradation or loss of functionality.



PIN CONFIGURATIONS AND FUNCTION DESCRIPTIONS

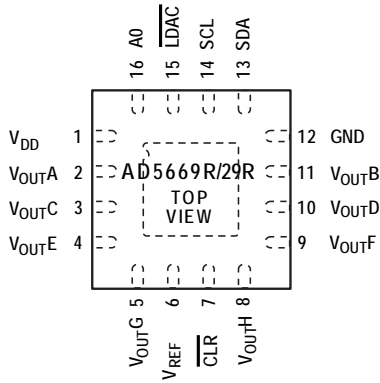

Figure 2. 16-Lead LFCSP (CP-16-17)

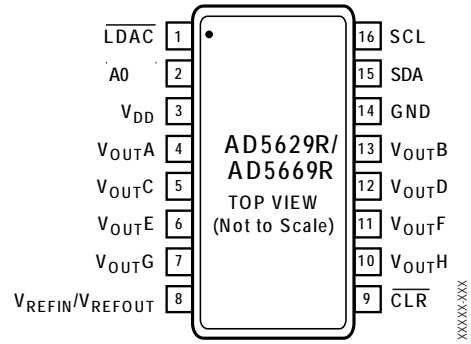

Figure 3. 16-Lead TSSOP (RU-16)

Table 6. Pin Function Descriptions

Pin No.		Mnemonic	Description
16-Lead LFCSP	16-Lead TSSOP		
15	1	$\overline{\text{LDAC}}$	Pulsing this pin low allows any or all DAC registers to be updated if the input registers have new data. This allows all DAC outputs to simultaneously update. Alternatively, this pin can be tied permanently low.
16	2	A0	Address Input. Sets the least significant bit of the 7-bit slave address.
1	3	V <sub>DD</sub>	Power Supply Input. These parts can be operated from 2.7 V to 5.5 V, and the supply should be decoupled with a 10 μF capacitor in parallel with a 0.1 μF capacitor to GND.
2	4	V <sub>OUTA</sub>	Analog Output Voltage from DAC A. The output amplifier has rail-to-rail operation.
11	13	V <sub>OUTB</sub>	Analog Output Voltage from DAC B. The output amplifier has rail-to-rail operation.
3	5	V <sub>OUTC</sub>	Analog Output Voltage from DAC C. The output amplifier has rail-to-rail operation.
10	12	V <sub>OUTD</sub>	Analog Output Voltage from DAC D. The output amplifier has rail-to-rail operation.
6	8	V <sub>REFIN</sub> /V <sub>REFOUT</sub>	The AD5629R/AD5669R has a common pin for reference input and reference output. When using the internal reference, this is the reference output pin. When using an external reference, this is the reference input pin. The default for this pin is as a reference input.
7	9	$\overline{\text{CLR}}$	Asynchronous Clear Input. The $\overline{\text{CLR}}$ input is falling edge sensitive. When $\overline{\text{CLR}}$ is low, all $\overline{\text{LDAC}}$ pulses are ignored. When $\overline{\text{CLR}}$ is activated, the input register and the DAC register are updated with the data contained in the CLR code register—zero, midscale, or full scale. Default setting clears the output to 0 V.
4	6	V <sub>OUTE</sub>	Analog Output Voltage from DAC E. The output amplifier has rail-to-rail operation.
9	11	V <sub>OUTF</sub>	Analog Output Voltage from DAC F. The output amplifier has rail-to-rail operation.
5	7	V <sub>OUTG</sub>	Analog Output Voltage from DAC G. The output amplifier has rail-to-rail operation.
8	10	V <sub>OUTH</sub>	Analog Output Voltage from DAC H. The output amplifier has rail-to-rail operation.
12	14	GND	Ground Reference Point for All Circuitry on the Part.
13	15	SDA	Serial Data Input. This device has a 32-bit shift register. Data is clocked into the register on the falling edge of the serial clock input.
14	16	SCL	Serial Clock Input. Data is clocked into the input shift register on the falling edge of the serial clock input.

TYPICAL PERFORMANCE CHARACTERISTICS

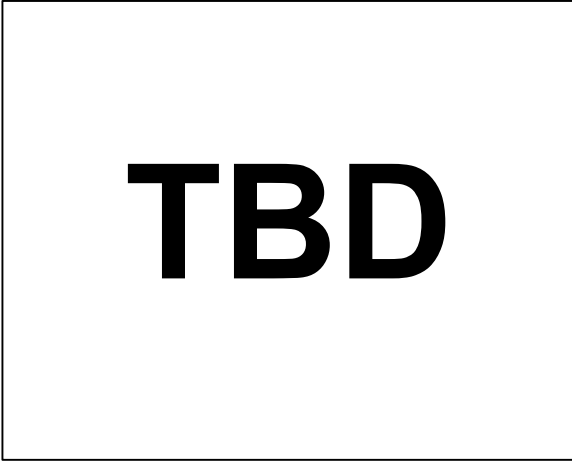

Figure 4. INL AD5669R—External Reference

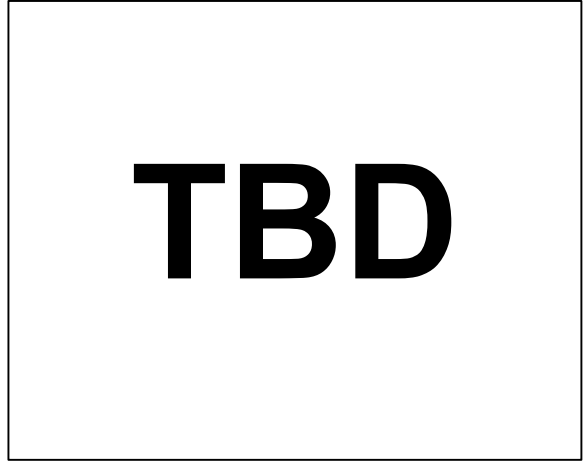

Figure 7. DNL AD5629R—External Reference

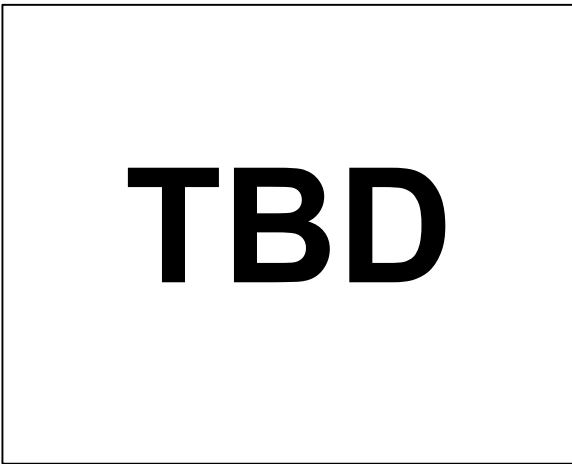

Figure 5. INL AD5629R—External Reference

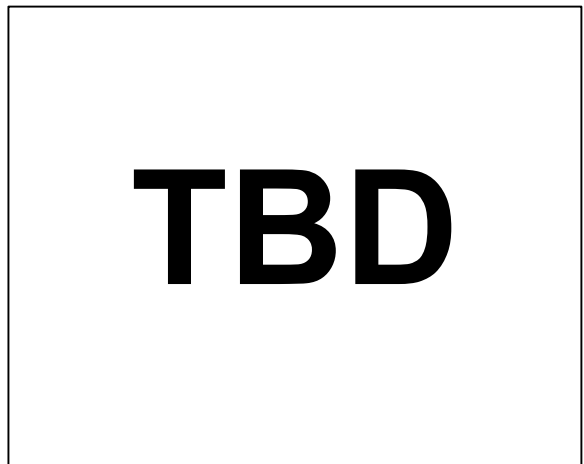

Figure 8. INL AD5669R-2/AD5669R-3

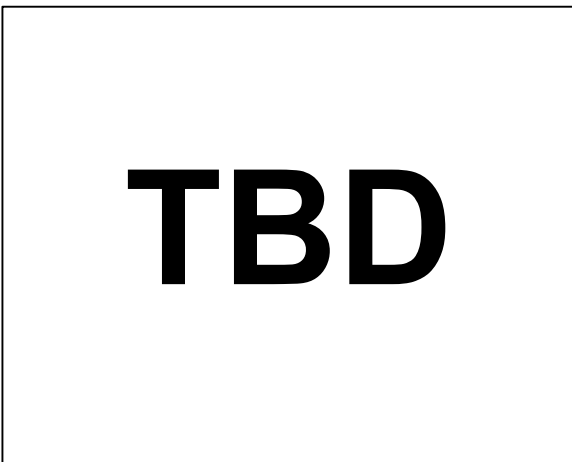

Figure 6. DNL AD5669R—External Reference

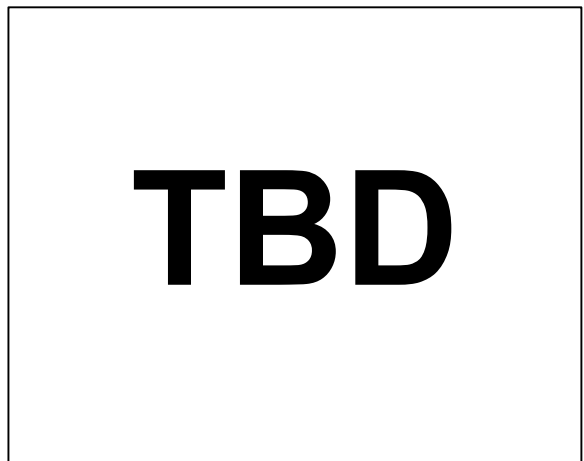

Figure 9

Figure 10. INL AD5629R-2

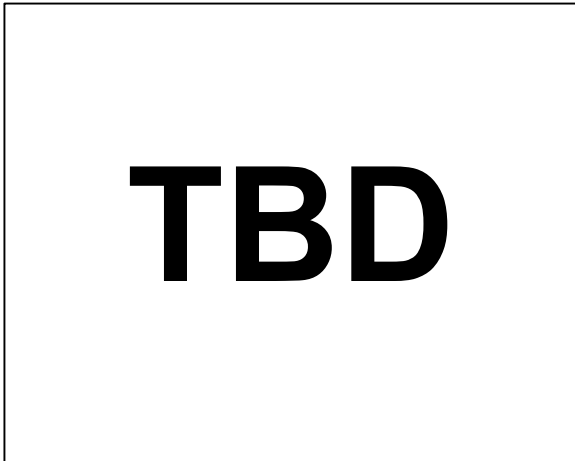

Figure 11. DNL AD5669R-2/AD5669R-3

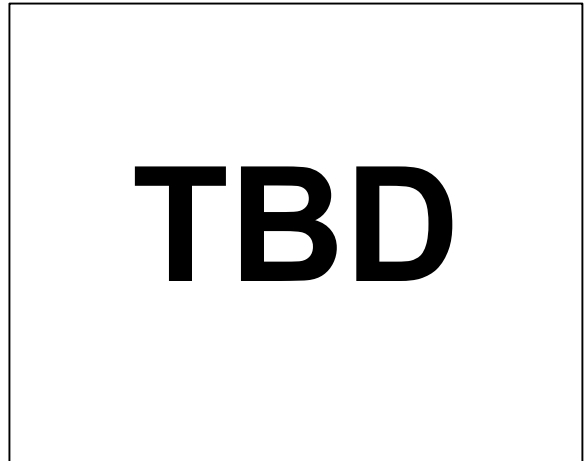

Figure 14. INL AD5629R-1

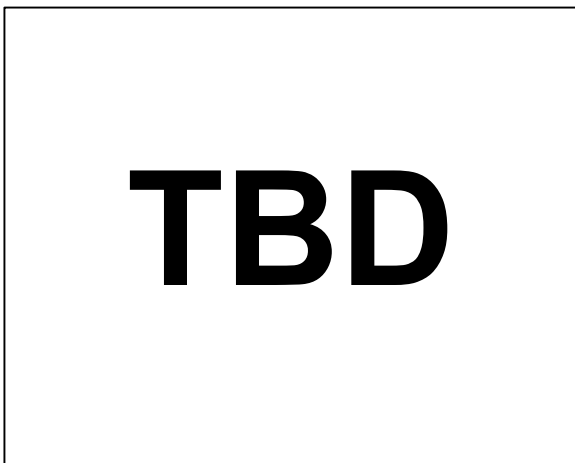

Figure 12. DNL AD5629R-2

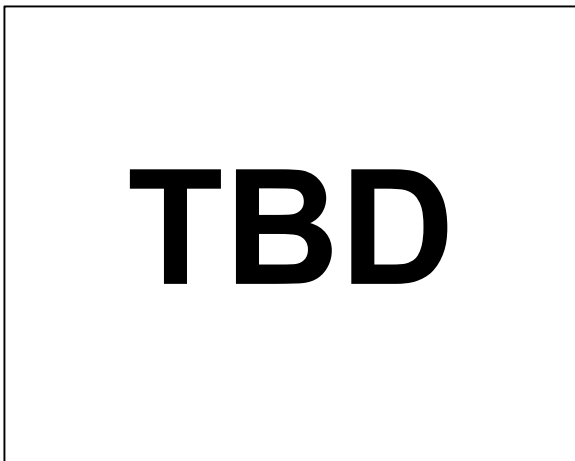
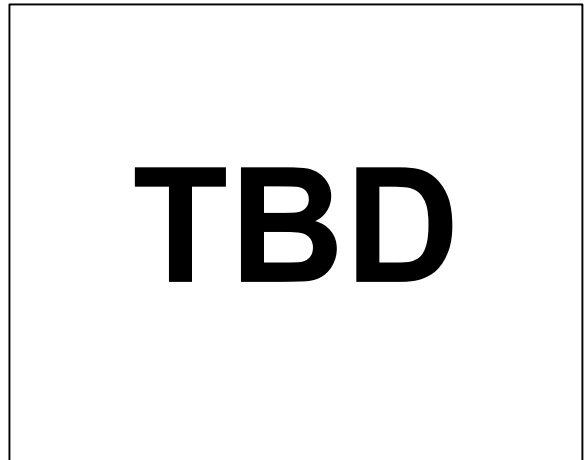

Figure 13. INL AD5669R-1

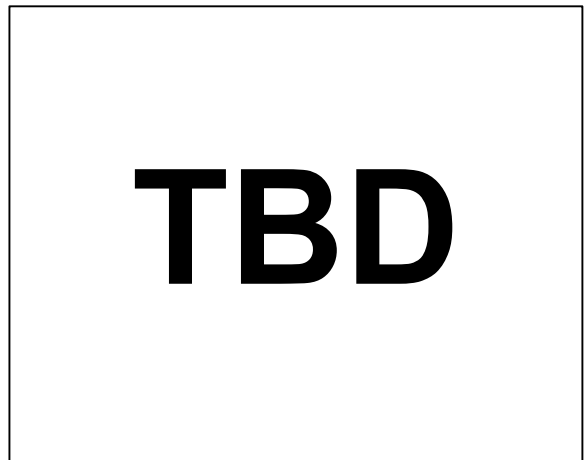

Figure 15. DNL AD5629R-1

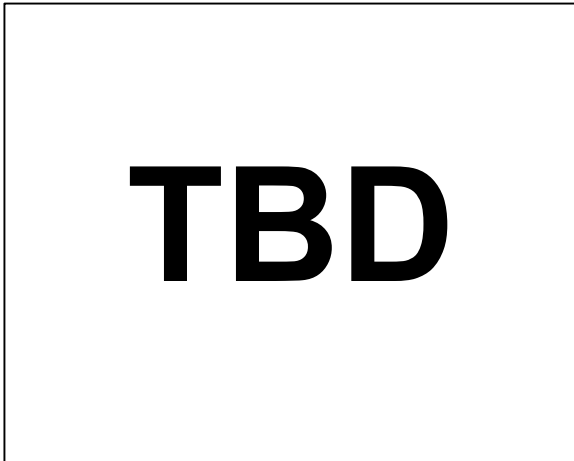

Figure 16.

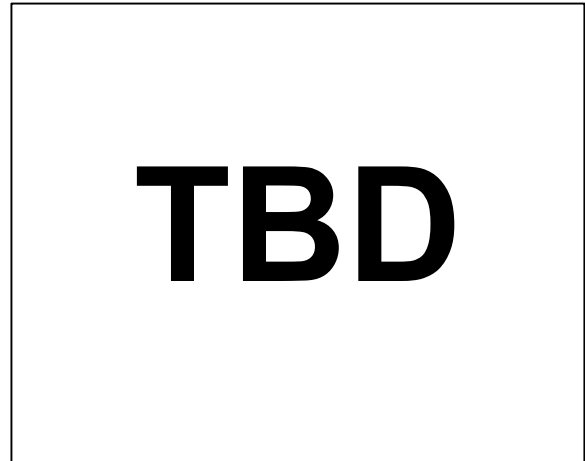

Figure 20.

Figure 17. Gain Error and Full-Scale Error vs. Temperature

Figure 21. Gain Error and Full-Scale Error vs. Supply Voltage

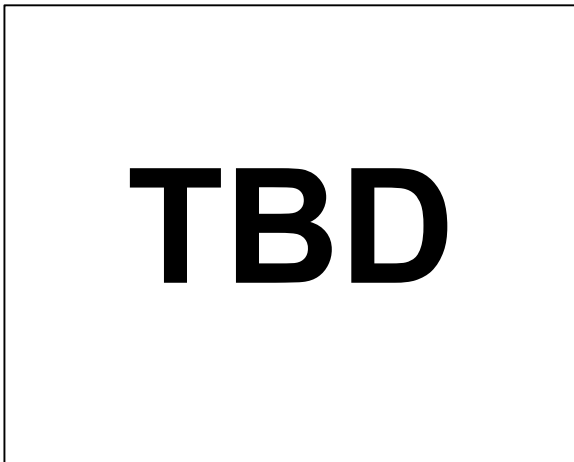

Figure 18.

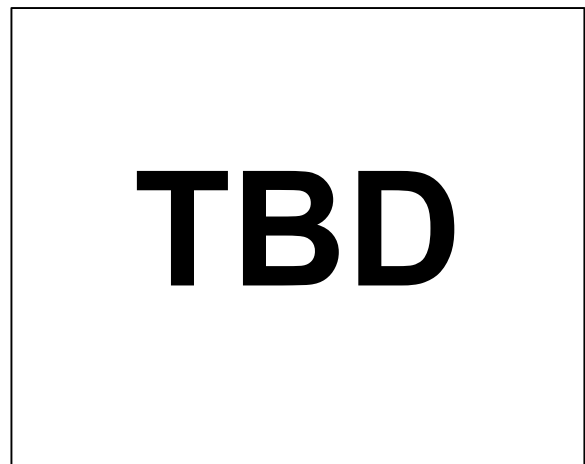

Figure 22.

Figure 23. Zero-Scale Error and Offset Error vs. Supply Voltage

Figure 19. Zero-Scale Error and Offset Error vs. Temperature

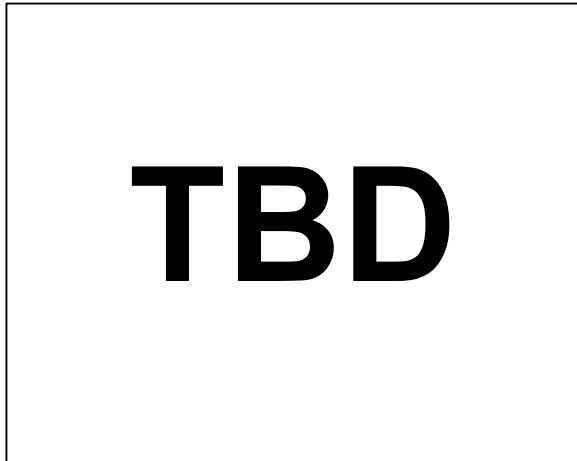

Figure 24.

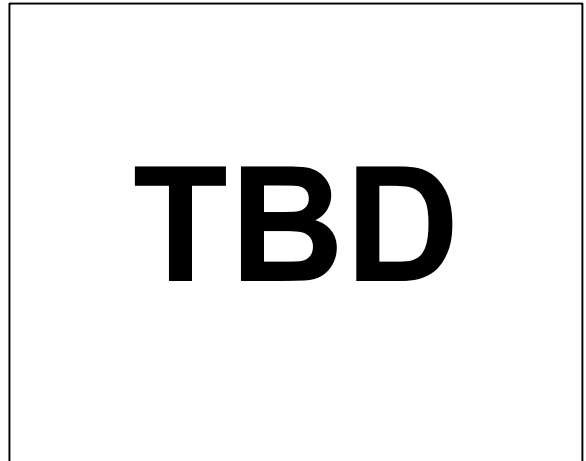

Figure 27.

Figure 25.  $I_{DD}$  Histogram with External Reference

Figure 28. Headroom at Rails vs. Source and Sink

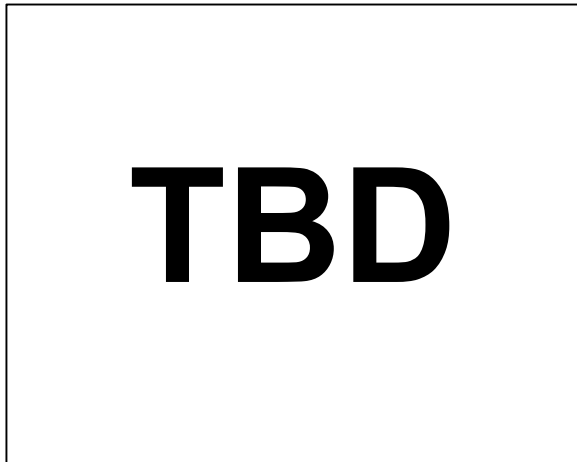

Figure 26.  $I_{DD}$  Histogram with Internal Reference

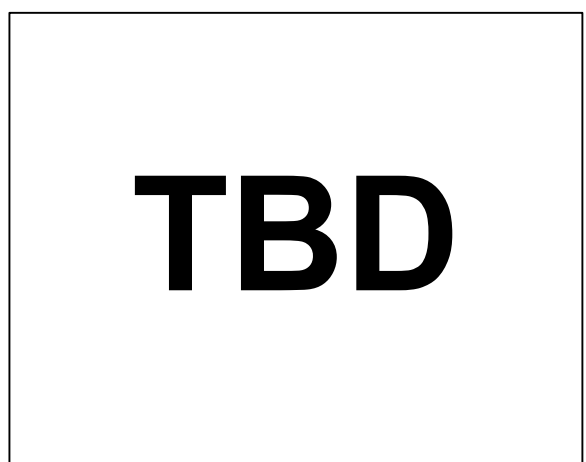

Figure 29.

Figure 30. AD5669R-2/AD5669R-3 Source and Sink Capability

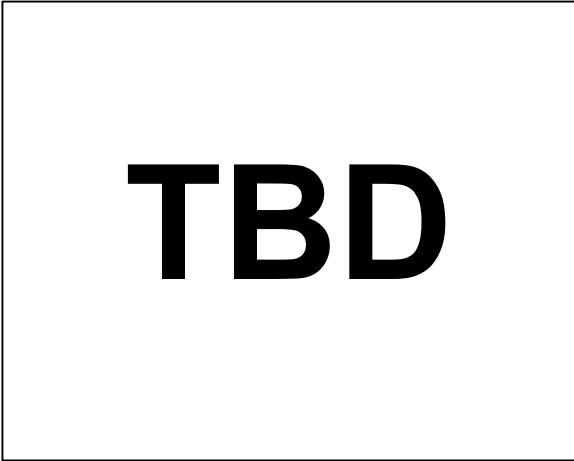

Figure 31.

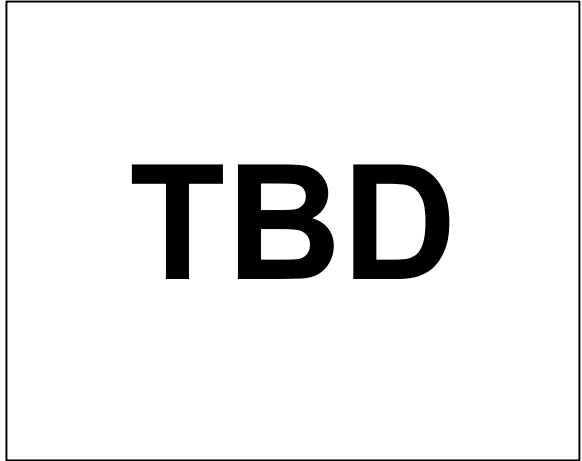

Figure 35.

Figure 32. AD5669R-1 Source and Sink Capability

Figure 36. Supply Current vs. Temperature

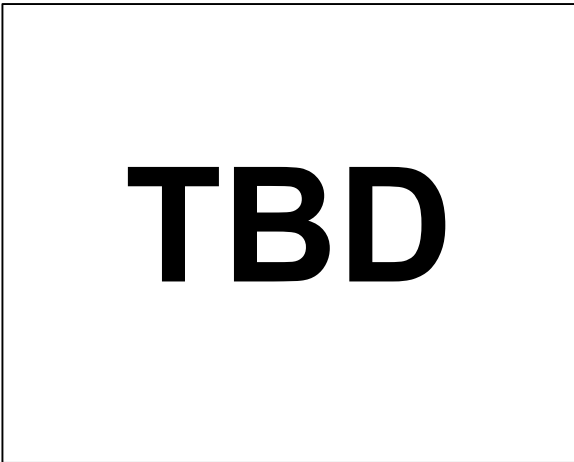

Figure 33.

Figure 34. Supply Current vs. Code

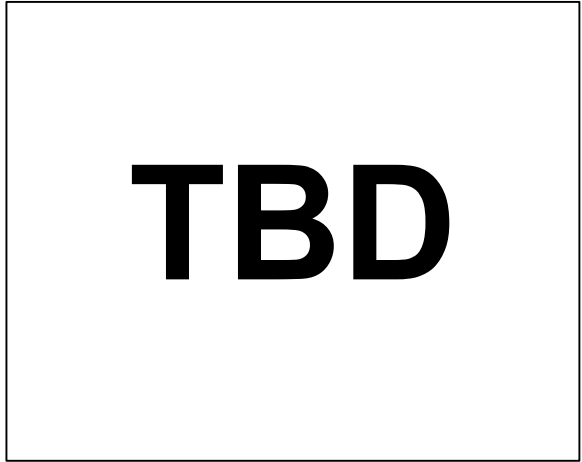

Figure 37.

Figure 38. Supply Current vs. Supply Voltage



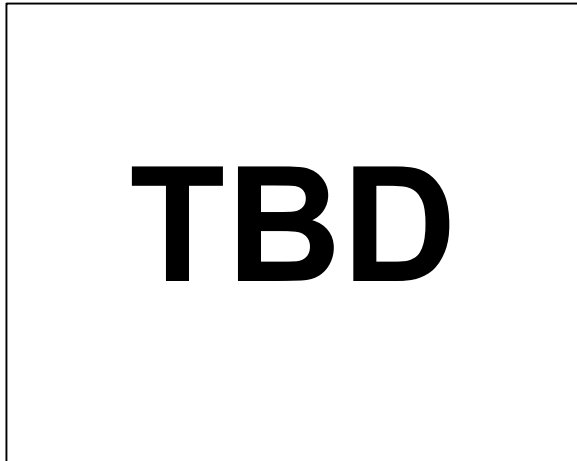

Figure 39.

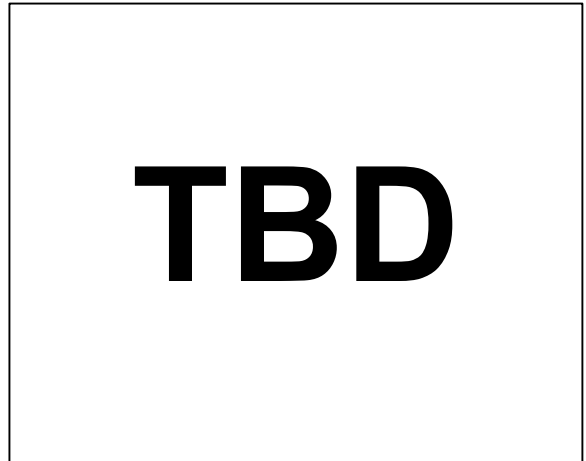

Figure 43. Power-On Reset to 0 V

Figure 40. Supply Current vs. Logic Input Voltage

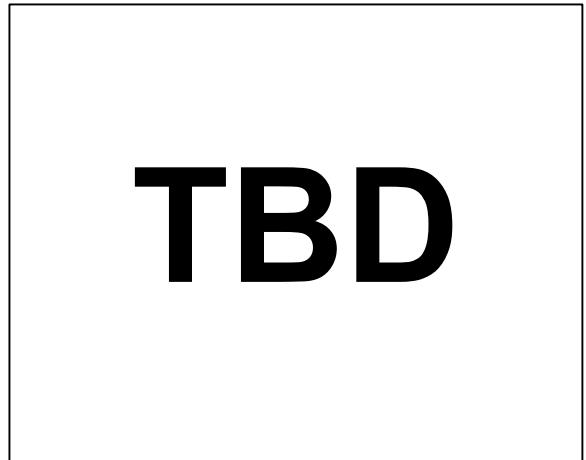

Figure 44.

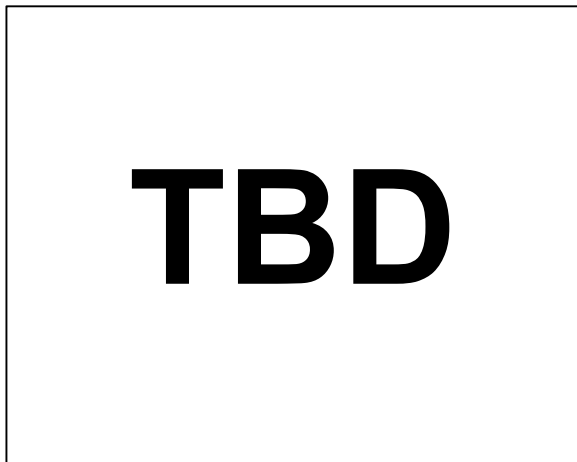

Figure 41.

Figure 45. Power-On Reset to Midscale

Figure 42. Full-Scale Settling Time, 5 V

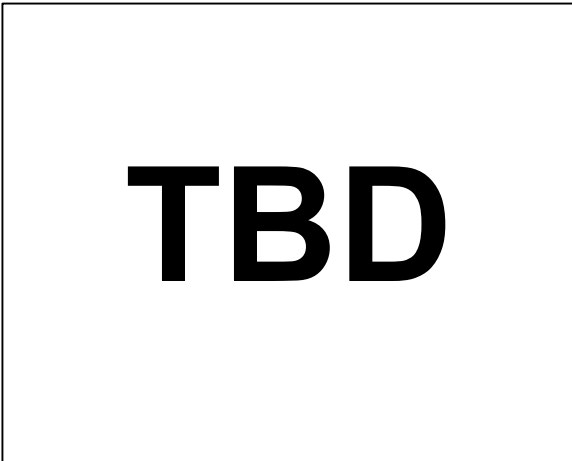

Figure 46.

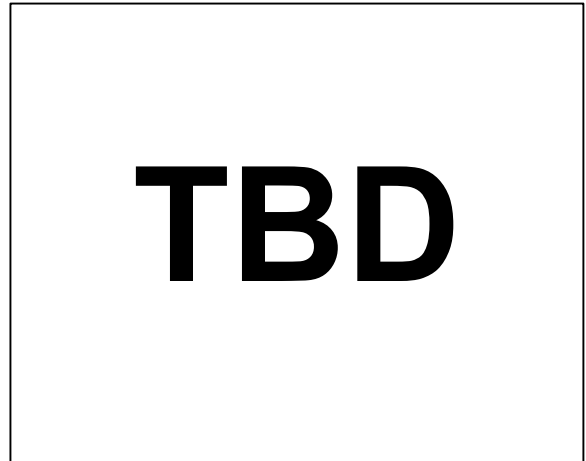

Figure 50.

Figure 47. Exiting Power-Down to Midscale

Figure 51. Analog Crosstalk

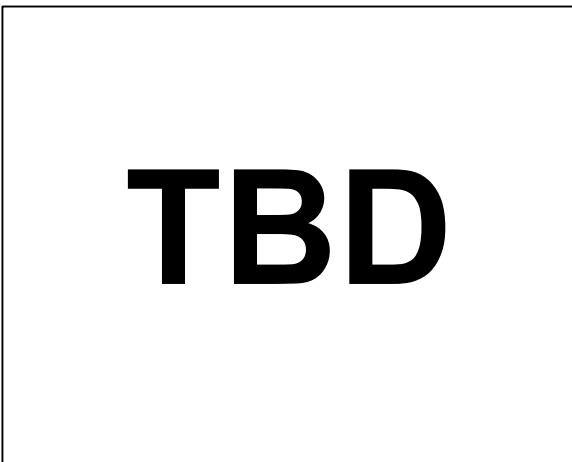

Figure 48.

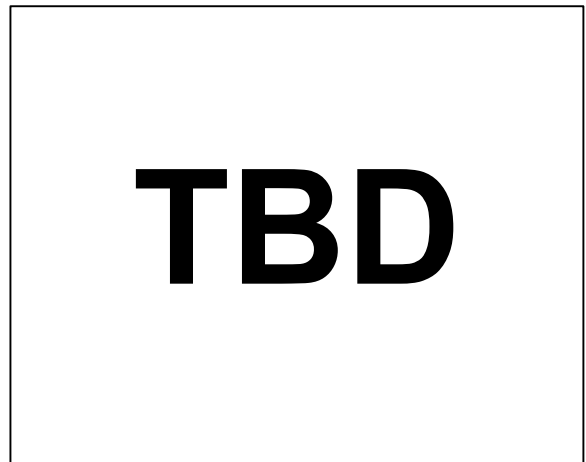

Figure 52.

Figure 49. Digital-to-Analog Glitch Impulse (Negative)

Figure 53. DAC-to-DAC Crosstalk

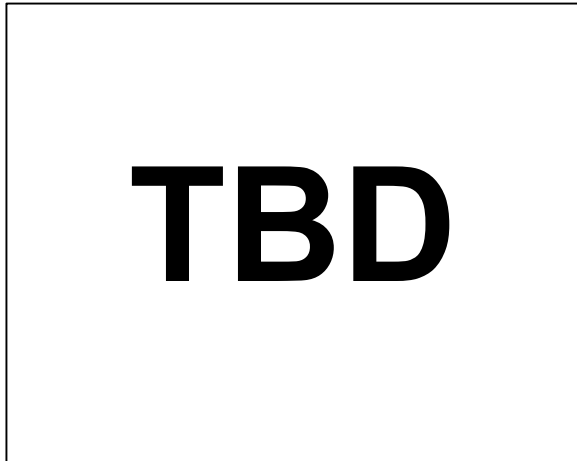

Figure 54.

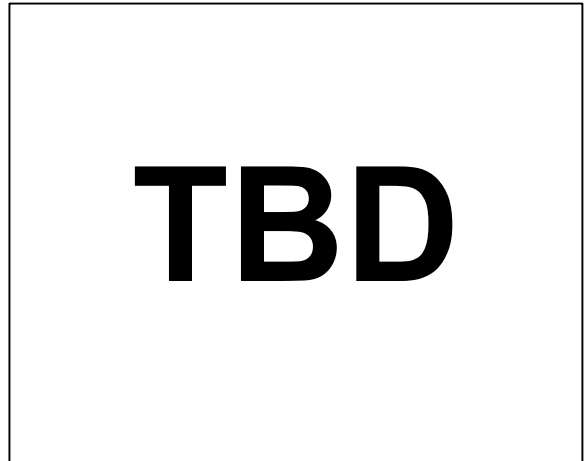

Figure 58.

Figure 55. 0.1 Hz to 10 Hz Output Noise Plot, External Reference

Figure 59. 0.1 Hz to 10 Hz Output Noise Plot, Internal Reference

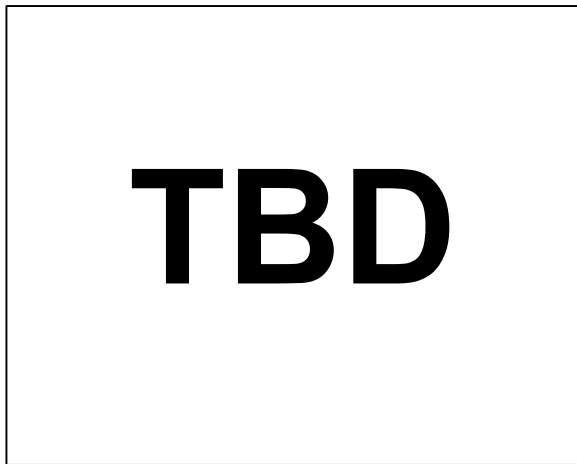

Figure 56

Figure 57. 0.1 Hz to 10 Hz Output Noise Plot, Internal Reference

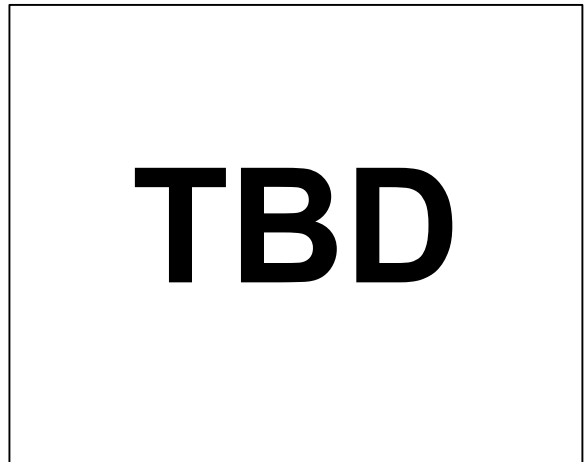

Figure 60.

Figure 61. Noise Spectral Density, Internal Reference



TBD

Figure 62.



TBD

Figure 66.

Figure 63. Total Harmonic Distortion

Figure 67. Hardware  $\overline{CLR}$



TBD

Figure 64.



TBD

Figure 68.

Figure 65. Settling Time vs. Capacitive Load

Figure 69. Multiplying Bandwidth

## TERMINOLOGY

### Relative Accuracy

For the DAC, relative accuracy, or integral nonlinearity (INL), is a measure of the maximum deviation in LSBs from a straight line passing through the endpoints of the DAC transfer function. Figure 4 to Figure 5, Figure 8 to Figure 10, and Figure 13 to Figure 14 show plots of typical INL vs. code.

### Differential Nonlinearity

Differential nonlinearity (DNL) is the difference between the measured change and the ideal 1 LSB change between any two adjacent codes. A specified differential nonlinearity of  $\pm 1$  LSB maximum ensures monotonicity. This DAC is guaranteed monotonic by design. Figure 6 to Figure 7, Figure 11 to Figure 12, and **Error! Reference source not found.** to **Error! Reference source not found.** show plots of typical DNL vs. code.

### Offset Error

Offset error is a measure of the difference between the actual  $V_{OUT}$  and the ideal  $V_{OUT}$ , expressed in millivolts in the linear region of the transfer function. Offset error is measured on the AD5669R with Code 512 loaded into the DAC register. It can be negative or positive and is expressed in millivolts.

### Zero-Code Error

Zero-code error is a measure of the output error when zero code (0x0000) is loaded into the DAC register. Ideally, the output should be 0 V. The zero-code error is always positive because the output of the DAC cannot go below 0 V. It is due to a combination of the offset errors in the DAC and output amplifier. Zero-code error is expressed in millivolts. Figure 23 shows a plot of typical zero-code error vs. temperature.

### Gain Error

Gain error is a measure of the span error of the DAC. It is the deviation in slope of the DAC transfer characteristic from the ideal, expressed as a percentage of the full-scale range.

### Zero-Code Error Drift

Zero-code error drift is a measure of the change in zero-code error with a change in temperature. It is expressed in  $\mu\text{V}/^\circ\text{C}$ .

### Gain Error Drift

Gain error drift is a measure of the change in gain error with changes in temperature. It is expressed in (ppm of full-scale range)/ $^\circ\text{C}$ .

### Full-Scale Error

Full-scale error is a measure of the output error when full-scale code (0xFFFF) is loaded into the DAC register. Ideally, the output should be  $V_{DD} - 1$  LSB. Full-scale error is expressed as a percentage of the full-scale range. Figure 17 shows a plot of typical full-scale error vs. temperature.

### Digital-to-Analog Glitch Impulse

Digital-to-analog glitch impulse is the impulse injected into the analog output when the input code in the DAC register changes state. It is normally specified as the area of the glitch in nV-s and is measured when the digital input code is changed by 1 LSB at the major carry transition (0x7FFF to 0x8000). See Figure 49.

### DC Power Supply Rejection Ratio (PSRR)

PSRR indicates how the output of the DAC is affected by changes in the supply voltage. PSRR is the ratio of the change in  $V_{OUT}$  to a change in  $V_{DD}$  for full-scale output of the DAC. It is measured in decibels.  $V_{REF}$  is held at 2 V, and  $V_{DD}$  is varied  $\pm 10\%$ .

### DC Crosstalk

DC crosstalk is the dc change in the output level of one DAC in response to a change in the output of another DAC. It is measured with a full-scale output change on one DAC (or soft power-down and power-up) while monitoring another DAC kept at midscale. It is expressed in microvolts.

DC crosstalk due to load current change is a measure of the impact that a change in load current on one DAC has to another DAC kept at midscale. It is expressed in microvolts per milliamp.

### Reference Feedthrough

Reference feedthrough is the ratio of the amplitude of the signal at the DAC output to the reference input when the DAC output is not being updated (that is,  $\overline{\text{LDAC}}$  is high). It is expressed in decibels.

### Digital Feedthrough

Digital feedthrough is a measure of the impulse injected into the analog output of a DAC from the digital input pins of the device, but is measured when the DAC is not being written to. It is specified in nV-s and measured with a full-scale change on the digital input pins, that is, from all 0s to all 1s or vice versa.

### Digital Crosstalk

Digital crosstalk is the glitch impulse transferred to the output of one DAC at midscale in response to a full-scale code change (all 0s to all 1s or vice versa) in the input register of another DAC. It is measured in standalone mode and is expressed in nV-s.

### Analog Crosstalk

Analog crosstalk is the glitch impulse transferred to the output of one DAC due to a change in the output of another DAC. It is measured by loading one of the input registers with a full-scale code change (all 0s to all 1s or vice versa) while keeping  $\overline{\text{LDAC}}$  high, and then pulsing  $\overline{\text{LDAC}}$  low and monitoring the output of the DAC whose digital code has not changed. The area of the glitch is expressed in nV-s.

### DAC-to-DAC Crosstalk

DAC-to-DAC crosstalk is the glitch impulse transferred to the output of one DAC due to a digital code change and subsequent output change of another DAC. This includes both digital and analog crosstalk. It is measured by loading one of the DACs with a full-scale code change (all 0s to all 1s or vice versa) with  $\overline{\text{LDAC}}$  low and monitoring the output of another DAC. The energy of the glitch is expressed in nV-s.

**Multiplying Bandwidth**

The amplifiers within the DAC have a finite bandwidth. The multiplying bandwidth is a measure of this. A sine wave on the reference (with full-scale code loaded to the DAC) appears on the output. The multiplying bandwidth is the frequency at which the output amplitude falls to 3 dB below the input.

**Total Harmonic Distortion (THD)**

Total harmonic distortion is the difference between an ideal sine wave and its attenuated version using the DAC. The sine wave is used as the reference for the DAC, and the THD is a measure of the harmonics present on the DAC output. It is measured in decibels.

## THEORY OF OPERATION

### D/A SECTION

The AD5629R/AD5669R are fabricated on a CMOS process. The architecture consists of a string of DACs followed by an output buffer amplifier. Each part includes an internal 1.25 V/2.5 V, 5 ppm/°C reference with an internal gain of 2. Figure 71 shows a block diagram of the DAC architecture.

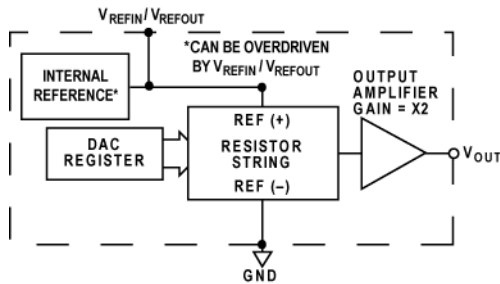

Figure 70 DAC Architecture for internal reference configuration

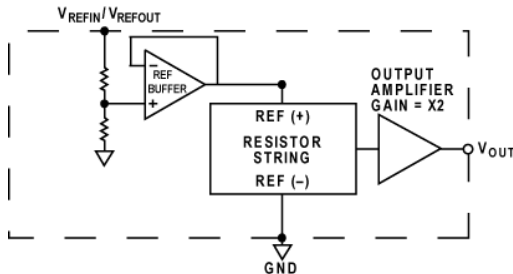

Figure 71. DAC Architecture for external reference configuration

Because the input coding to the DAC is straight binary, the ideal output voltage when using an external reference is given by

$$V_{OUT} = V_{REFIN} \times \left(\frac{D}{2^N}\right)$$

The ideal output voltage when using the internal reference is given by

$$V_{OUT} = 2 \times V_{REFOUT} \times \left(\frac{D}{2^N}\right)$$

where:

$D$  = decimal equivalent of the binary code that is loaded to the DAC register.

0 to 4095 for AD5629R (12 bits).

0 to 65,535 for AD5669R (16 bits).

$N$  = the DAC resolution.

### RESISTOR STRING

The resistor string section is shown in Figure 72. It is simply a string of resistors, each of value  $R$ . The code loaded into the DAC register determines at which node on the string the voltage is tapped off to be fed into the output amplifier. The voltage is tapped off by closing one of the switches connecting

the string to the amplifier. Because it is a string of resistors, it is guaranteed monotonic.

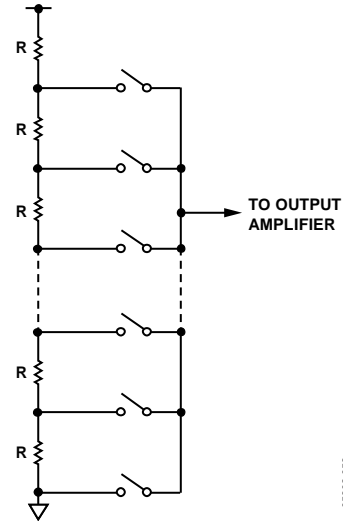

Figure 72. Resistor String

06302-063

### INTERNAL REFERENCE

The AD5629R/AD5669R have an on-chip reference with an internal gain of 2. The AD5629R/AD5669R have a 1.25 V, 5 ppm/°C reference, giving a full-scale output of 2.5 V; or a 2.5 V, 5 ppm/°C reference, which will only work from 4.5 to 5.5V giving a full-scale output of 5 V. The on-board reference is off at power-up, allowing the use of an external reference. The internal reference is enabled via a write to the control register (see Table 8).

The internal reference associated with each part is available at the  $V_{REFOUT}$  pin. A buffer is required if the reference output is used to drive external loads. When using the internal reference, it is recommended that a 100 nF capacitor be placed between the reference output and GND for reference stability.

Individual channel power-down is not supported while using the internal reference.

## OUTPUT AMPLIFIER

The output buffer amplifier can generate rail-to-rail voltages on its output, which gives an output range of 0 V to  $V_{DD}$ . The amplifier is capable of driving a load of 2 k $\Omega$  in parallel with 1000 pF to GND. The source and sink capabilities of the output amplifier can be seen in Figure 30 and Figure 32. The slew rate is 1.5 V/ $\mu$ s with a  $\frac{1}{4}$  to  $\frac{3}{4}$  scale settling time of 10  $\mu$ s.

## SERIAL INTERFACE

The AD5629R/AD5669R have 2-wire I<sup>2</sup>C-compatible serial interfaces (refer to *The I<sup>2</sup>C-Bus Specification*, Version 2.1, January 2000, available from Philips Semiconductor). The AD5629R/AD5669R can be connected to an I<sup>2</sup>C bus as a slave device, under the control of a master device. See Figure X for a timing diagram of a typical write sequence.

The AD5629R/AD5669R support standard (100 kHz) and fast (400 kHz) modes. High speed operation is only available on selected models.

See the ordering guide for a full list of models. Support is not provided for 10-bit addressing and general call addressing.

The AD5629R/AD5669R each has a 7-bit slave address. The part have a slave address whose five MSBs are 10101, and the two LSBs are set by the state of the A0 address pin, which determines the state of the A0 and A1 address bits.

The facility to make hardwired changes to the A0 pin allows the user to incorporate up to three of these devices on one bus, as outlined in Table 7.

**Table 7. ADDR Pin Settings (16-Lead Package)**

A0 Pin Connection	A1	A0
$V_{DD}$	0	0
NC	1	0
GND	1	1

The 2-wire serial bus protocol operates as follows:

1. The master initiates data transfer by establishing a start condition when a high-to-low transition on the SDA line occurs while SCL is high. The following byte is the address byte, which consists of the 7-bit slave address. The slave address corresponding to the transmitted address responds by pulling SDA low during the ninth clock pulse (this is termed the acknowledge bit). At this stage, all other devices on the bus remain idle while the selected device waits for data to be written to or read from its shift register.

2. Data is transmitted over the serial bus in sequences of nine clock pulses (eight data bits followed by an acknowledge bit). The transitions on the SDA line must occur during the low period of SCL and remain stable during the high period of SCL.

When all data bits have been read or written, a stop condition is established. In write mode, the master pulls the SDA line high during the 10<sup>th</sup> clock pulse to establish a stop condition. In read mode, the master issues a no acknowledge for the ninth clock pulse (that is, the SDA line remains high). The master brings the SDA line low before the 10<sup>th</sup> clock pulse, and then high during the 10<sup>th</sup> clock pulse to establish a stop condition.

## WRITE OPERATION

When writing to the AD5629R/AD5669R, the user must begin with a start command followed by an address byte ( $R/\overline{W} = 0$ ), after which the DAC acknowledges that it is prepared to receive data by pulling SDA low. The AD5629R/AD5669R requires two bytes of data for the DAC and a command byte that controls various DAC functions. Three bytes of data must therefore be written to the DAC, the command byte followed by the most significant data byte and the least significant data byte, as shown in Figures. After these data bytes are acknowledged by the AD5629R/AD5669R, a stop condition follows.

## READ OPERATION

When reading data back from the AD5629R/AD5669R, the user begins with a start command followed by an address byte ( $R/\overline{W} = 1$ ), after which the DAC acknowledges that it is prepared to transmit data by pulling SDA low. Two bytes of data are then read from the DAC, which are both acknowledged by the master as shown in Figure 74 and Figure XX. A stop condition follows.



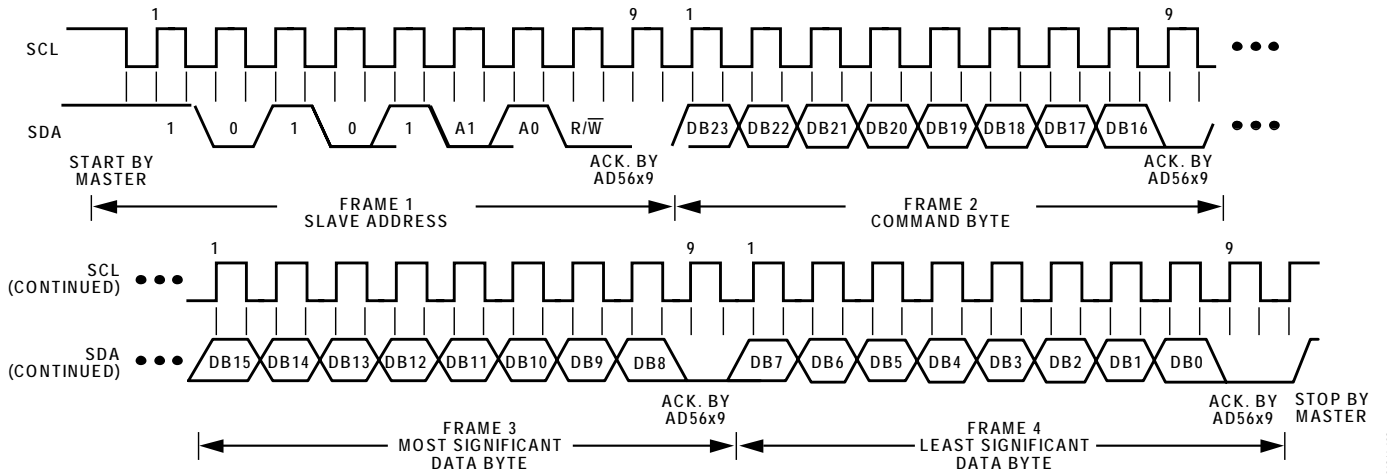

Figure 73. I<sup>2</sup>C Write Operation

06341-103

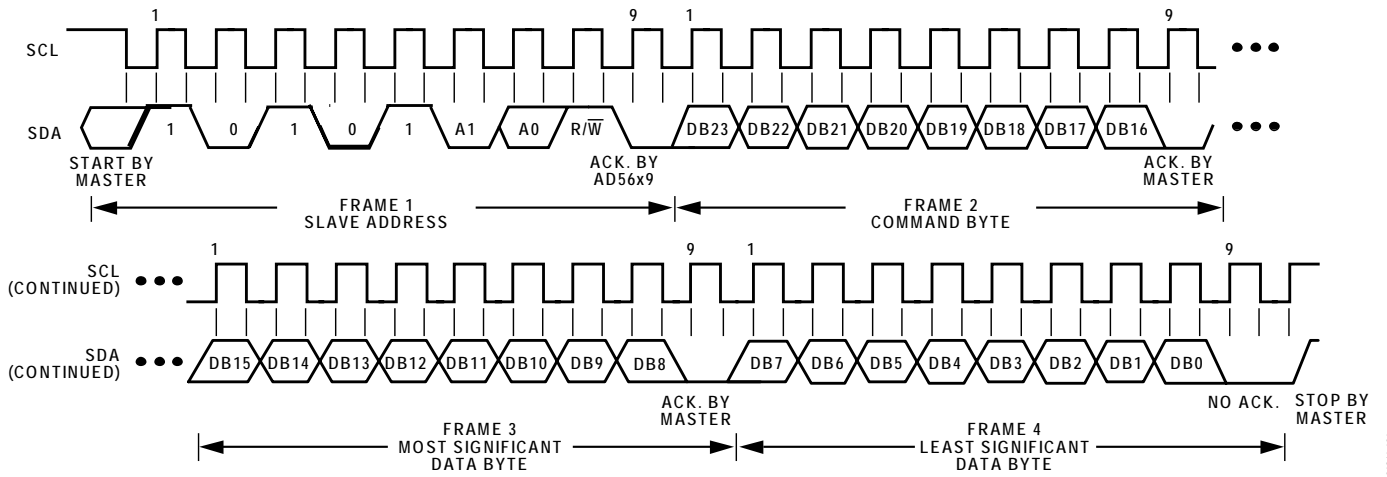

Figure 74. I<sup>2</sup>C Read Operation

06341-101

Table 8. Command Definitions

Command				Description
C3	C2	C1	C0	
0	0	0	0	Write to Input Register n
0	0	0	1	Update DAC Register n
0	0	1	0	Write to Input Register n, update all (software LDAC)
0	0	1	1	Write to and update DAC Channel n
0	1	0	0	Power down/power up DAC <sup>1</sup>
0	1	0	1	Load clear code register
0	1	1	0	Load LDAC register
0	1	1	1	Reset (power-on reset)
1	0	0	0	Set up internal REF register
1	0	0	1	Enable multiple byte mode
–	–	–	–	Reserved
1	1	1	1	Reserved

Table 9. Address Commands

Address (n)				Selected DAC Channel
A3	A2	A1	A0	
0	0	0	0	DAC A
0	0	0	1	DAC B
0	0	1	0	DAC C
0	0	1	1	DAC D
0	1	0	0	DAC E
0	1	0	1	DAC F
0	1	1	0	DAC G
0	1	1	1	DAC H
1	1	1	1	All DACs

<sup>1</sup> Available on AD5629R and AD5669R versions only.

**INPUT SHIFT REGISTER**

The input shift register is 24 bits wide. Data is loaded into the device as a 24-bit word under the control of a serial clock input, SCL. The timing diagram for this operation is shown in Figure X. The eight MSBs make up the command byte. DB23-DB20 are the command bits (C3, C2, C1, and C0) that control the mode of operation of the device. See Table 9 for details. The last four bits of the first byte are the address bits (A3, A2, A1, and A0). See Table 10 for details. The rest of the bits are the 16-/12-bit data word. The data word comprises the 16-/12-bit input code followed by four don't cares for the device (see Figure 57 and Figure 58).

**MULTIPLE BYTE OPERATION**

Multiple byte operation is supported on the AD5629R /AD5669R. Command 1001 is reserved for multiple byte operation (see Table 8). A 2-byte operation is useful for applications that require fast DAC updating and do not need to change the command byte. The S bit (DB22) in the command register can be set to 1 for 2-byte mode of operation (see Figure 62). For standard 3-byte and 4-byte operation, the S bit (DB22) in the command byte should be set to 0 (see Figure 61).

DB23	DB22	DB21	DB20	DB19	DB18	DB17	DB16	DB15	DB14	DB13	DB12	DB11	DB10	DB9	DB8	DB7	DB6	DB5	DB4	DB3	DB2	DB1	DB0
C3	C2	C1	C0	A3	A2	A1	A0	D15	D14	D13	D12	D11	D10	D9	D8	D7	D6	D5	D4	D3	D2	D1	D0
COMMAND				DAC ADDRESS				DAC DATA								DAC DATA							
COMMAND BYTE								DATA HIGH BYTE								DATA LOW BYTE							

Figure 75. AD5669R/AD5669 Input Register Contents

DB23	DB22	DB21	DB20	DB19	DB18	DB17	DB16	DB15	DB14	DB13	DB12	DB11	DB10	DB9	DB8	DB7	DB6	DB5	DB4	DB3	DB2	DB1	DB0
C3	C2	C1	C0	A3	A2	A1	A0	D11	D10	D9	D8	D7	D6	D5	D4	D3	D2	D1	D0	X	X	X	X
COMMAND				DAC ADDRESS				DAC DATA								DAC DATA							
COMMAND BYTE								DATA HIGH BYTE								DATA LOW BYTE							

Figure 76. AD5629R/AD5629 Input Register Contents

**INTERNAL REFERENCE REGISTER**

The internal reference is available on all versions. The on-board reference is off at power-up by default. This allows the use of an external reference if the application requires it. The on-board reference can be turned on or off by a user-programmable internal REF register by setting Bit DB0 high or low (see Table 10). DB1 selects the internal reference value. When DB1 is set to 1 the 1.25V reference is selected. When DB1 is set to 0 the 2.5V internal reference is selected. Command 1000 is reserved for setting the internal REF register (see Table 8). Table 12 shows how the state of the bits in the input shift register corresponds to the mode of operation of the device. Command 1000 is not functional in AD5669/29 models because there is no internal reference available.

**POWER-ON RESET**

The AD5629R/AD5669R family contains a power-on reset circuit that controls the output voltage during power-up. The AD5629R/AD5669R DAC output powers up to 0 V, and the AD5669R-3 DAC output powers up to midscale. The output remains powered up at this level until a valid write sequence is

made to the DAC. This is useful in applications where it is important to know the state of the output of the DAC while it is in the process of powering up. There is also a software executable reset function that resets the DAC to the power-on reset code. Command 0111 is reserved for this reset function (see Table 8). Any events on  $\overline{LDAC}$  or  $\overline{CLR}$  during power-on reset are ignored.

**POWER-DOWN MODES**

The AD5629R/AD5669R contain four separate modes of operation. Command 0100 is reserved for the power-down function (see Table 8). These modes are software-programmable by setting two bits, Bit DB9 and Bit DB8, in the control register.

Table 12 shows how the state of the bits corresponds to the mode of operation of the device. Any or all DACs (DAC H to DAC A) can be powered down to the selected mode by setting the corresponding eight bits (DB7 to DB0) to 1. See Table 13. Internal reference setup

DB9	DB8	Operating Mode
0	0	Internal reference off

0	1	2.5V internal reference on
1	0	Internal reference off
1	1	1.25V internal reference on

Table 14 for the contents of the input shift register during power-down/power-up operation. When using the internal reference, only all channel power-down to the selected modes is supported.

When both bits are set to 0, the part works normally with its normal power consumption of 1.3 mA at 5 V. However, for the three power-down modes, the supply current falls to 0.4  $\mu$ A at 5 V (0.2  $\mu$ A at 3 V). Not only does the supply current fall, but the output stage is also internally switched from the output of the amplifier to a resistor network of known values. This has the advantage that the output impedance of the part is known while the part is in power-down mode. There are three different options. The output is connected internally to GND through either a 1 k $\Omega$  or a 100 k $\Omega$  resistor, or it is left open-circuited (three-state). The output stage is illustrated in Figure 77.

The bias generator of the selected DAC(s), output amplifier, resistor string, and other associated linear circuitry are shut down when the power-down mode is activated. The internal reference is powered down only when all channels are powered down. However, the contents of the DAC register are unaffected when in power-down. The time to exit power-down is typically 4  $\mu$ s for  $V_{DD} = 5$  V and for  $V_{DD} = 3$  V. See Figure 47 for a plot.

Any combination of DACs can be powered up by setting PD1 and PD0 to 0 (normal operation). The output powers up to the

value in the input register ( $\overline{\text{LDAC}}$  low) or to the value in the DAC register before powering down ( $\overline{\text{LDAC}}$  high).

### CLEAR CODE REGISTER

The AD5629R/AD5669R have a hardware  $\overline{\text{CLR}}$  pin that is an asynchronous clear input. The  $\overline{\text{CLR}}$  input is falling edge sensitive. Bringing the  $\overline{\text{CLR}}$  line low clears the contents of the input register and the  $\overline{\text{DAC}}$  registers to the data contained in the user-configurable  $\overline{\text{CLR}}$  register and sets the analog outputs accordingly. This function can be used in system calibration to load zero scale, midscale, or full scale to all channels together. These clear code values are user-programmable by setting two bits, Bit DB1 and Bit DB0, in the  $\overline{\text{CLR}}$  control register (see

Table 15). The default setting clears the outputs to 0 V. Command 0101 is reserved for loading the clear code register (see Table 8).

The part exits clear code mode on the 32<sup>nd</sup> falling edge of the next write to the part. If  $\overline{\text{CLR}}$  is activated during a write sequence, the write is aborted.

The  $\overline{\text{CLR}}$  pulse activation time—the falling edge of  $\overline{\text{CLR}}$  to when the output starts to change—is typically 280 ns. However, if outside the DAC linear region, it typically takes 520 ns after executing  $\overline{\text{CLR}}$  for the output to start changing (see Figure 67).

See Table 16 for contents of the input shift register during the loading clear code register operation.

Table 10. Internal Reference Register

Internal REF Register (DB0)	Action
0	Reference off (default)
1	Reference on

Table 11. 32-Bit Input Shift Register Contents for Reference Set-Up Command

DB23	DB22	DB21	DB20	DB19	DB18	DB17	DB16	DB15 to DB2	DB1	DB0
1	0	0	0	X	X	X	X	X	1/0	1/0
Command bits (C3 to C0)				Address bits (A3 to A0)—don't cares				Don't cares	2.5V/1.25V internal REF	Internal REF on/off

Table 12. Power-Down Modes of Operation

DB9	DB8	Operating Mode
0	0	Normal operation
		Power-down modes
0	1	1 kΩ to GND
1	0	100 kΩ to GND
1	1	Three-state

Table 13. Internal reference setup

DB9	DB8	Operating Mode
0	0	Internal reference off
0	1	2.5V internal reference on
1	0	Internal reference off
1	1	1.25V internal reference on

Table 14. 32-Bit Input Shift Register Contents for Power-Down/Power-Up Function

DB23	DB22	DB21	DB20	DB19	DB18	DB17	DB16	DB15 to DB10	DB9	DB8	DB7	DB6	DB5	DB4	DB3	DB2	DB1	DB0	
0	1	0	0	X	X	X	X	X	PD1	PD0	DAC H	DAC G	DAC F	DAC E	DAC D	DAC C	DAC B	DAC A	
Command bits (C3 to C0)				Address bits (A3 to A0)—don't cares				Don't cares	Power-down mode	Power-down/power-up channel selection—set bit to 1 to select									

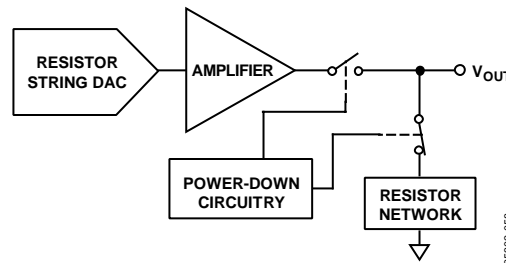

Figure 77. Output Stage During Power-Down

Table 15. Clear Code Register

Clear Code Register		Clears to Code
DB1	DB0	
CR1	CR0	
0	0	0x0000
0	1	0x8000

1	0	0xFFFF
1	1	No operation

Table 16. 32-Bit Input Shift Register Contents for Clear Code Function

										LSB	
DB23	DB22	DB21	DB20	DB19	DB18	DB17	DB16	DB15 to DB2	DB1	DB0	
0	1	0	1	X	X	X	X	X	CR1	CR0	
Command bits (C3 to C0)				Address bits (A3 to A0)—don't cares				Don't cares	Clear code register		

## LDAC FUNCTION

The outputs of all DACs can be updated simultaneously using the hardware  $\overline{\text{LDAC}}$  pin.

**Synchronous  $\overline{\text{LDAC}}$ :** After new data is read, the DAC registers are updated on.  $\overline{\text{LDAC}}$  can be permanently low or pulsed as in Figure.

**Asynchronous  $\overline{\text{LDAC}}$ :** The outputs are not updated at the same time that the input registers are written to. When  $\overline{\text{LDAC}}$  goes low, the DAC registers are updated with the contents of the input register.

Alternatively, the outputs of all DACs can be updated simultaneously using the software  $\overline{\text{LDAC}}$  function by writing to Input Register n and updating all DAC registers. Command 0011 is reserved for this software  $\overline{\text{LDAC}}$  function.

An  $\overline{\text{LDAC}}$  register gives the user extra flexibility and control over the hardware  $\overline{\text{LDAC}}$  pin. This register allows the user to select which combination of channels to simultaneously update when the hardware  $\overline{\text{LDAC}}$  pin is executed. Setting the  $\overline{\text{LDAC}}$  bit register to 0 for a DAC channel means that this channel's update is controlled by the  $\overline{\text{LDAC}}$  pin. If this bit is set to 1, this channel updates synchronously; that is, the DAC register is updated after new data is read, regardless of the state of the  $\overline{\text{LDAC}}$  pin. It effectively sees the  $\overline{\text{LDAC}}$  pin as being tied low. (See Table 17 for the  $\overline{\text{LDAC}}$  register mode of operation.) This flexibility is useful in applications where the user wants to simultaneously update select channels while the rest of the channels are synchronously updating. Writing to the DAC using command 0110 loads the 8-bit  $\overline{\text{LDAC}}$  register (DB7 to DB0). The default for each channel is 0, that is, the  $\overline{\text{LDAC}}$  pin works normally. Setting the bits to 1 means the DAC channel is updated regardless of the state of the  $\overline{\text{LDAC}}$  pin. See Table 18 for the contents of the input shift register during the load  $\overline{\text{LDAC}}$  register mode of operation.

## POWER SUPPLY BYPASSING AND GROUNDING

When accuracy is important in a circuit, it is helpful to carefully consider the power supply and ground return layout on the board. The printed circuit board containing the AD5629R/AD5669R should have separate analog and digital sections. If the AD5629R/AD5669R are in a system where other devices require an AGND-to-DGND connection, the connection should be made at one point only. This ground point should be as close as possible to the AD5629R/AD5669R.

The power supply to the AD5629R/AD5669R should be bypassed with 10  $\mu\text{F}$  and 0.1  $\mu\text{F}$  capacitors. The capacitors should physically be as close as possible to the device, with the 0.1  $\mu\text{F}$  capacitor ideally right up against the device. The 10  $\mu\text{F}$  capacitors are the tantalum bead type. It is important that the 0.1  $\mu\text{F}$  capacitor has low effective series resistance (ESR) and low effective series inductance (ESI), such as is typical of common ceramic types of capacitors. This 0.1  $\mu\text{F}$  capacitor provides a low impedance path to ground for high frequencies caused by transient currents due to internal logic switching.

The power supply line should have as large a trace as possible to provide a low impedance path and reduce glitch effects on the supply line. Clocks and other fast switching digital signals should be shielded from other parts of the board by digital ground. Avoid crossover of digital and analog signals if possible. When traces cross on opposite sides of the board, ensure that they run at right angles to each other to reduce feedthrough effects through the board. The best board layout technique is the microstrip technique, where the component side of the board is dedicated to the ground plane only and the signal traces are placed on the solder side. However, this is not always possible with a 2-layer board.

Table 17.  $\overline{\text{LDAC}}$  Register

Load DAC Register		$\overline{\text{LDAC}}$ Operation
$\overline{\text{LDAC}}$ Bits (DB7 to DB0)	$\overline{\text{LDAC}}$ Pin	
0	1/0	Determined by $\overline{\text{LDAC}}$ pin.
1	X—don't care	DAC channels update, overriding the $\overline{\text{LDAC}}$ pin. DAC channels see $\overline{\text{LDAC}}$ as 0.

Table 18. 32-Bit Input Shift Register Contents for  $\overline{\text{LDAC}}$  Register Function

																LSB
DB23	DB22	DB21	DB20	DB19	DB18	DB17	DB16	DB15 to DB8	DB7	DB6	DB5	DB4	DB3	DB2	DB1	DB0
0	1	1	0	X	X	X	X	X	DAC H	DAC G	DAC F	DAC E	DAC D	DAC C	DAC B	DAC A
Command bits (C3 to C0)				Address bits (A3 to A0)— don't cares				Don't cares	Setting $\overline{\text{LDAC}}$ bit to 1 overrides $\overline{\text{LDAC}}$ pin							

OUTLINE DIMENSIONS

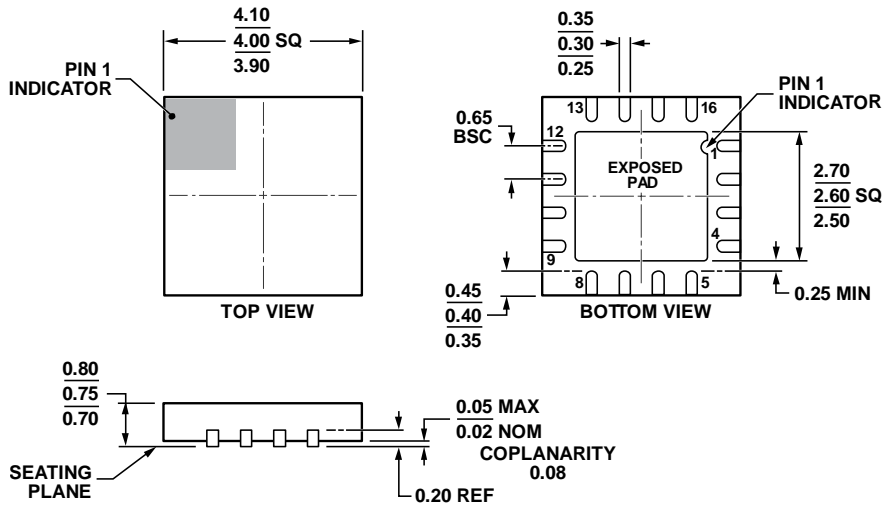

COMPLIANT TO JEDEC STANDARDS MO-220-WGGC.

Figure 78. 16-Lead Lead Frame Chip Scale Package [LFCS]  
(CP-16-17)

Dimensions shown in millimeters

012909-B

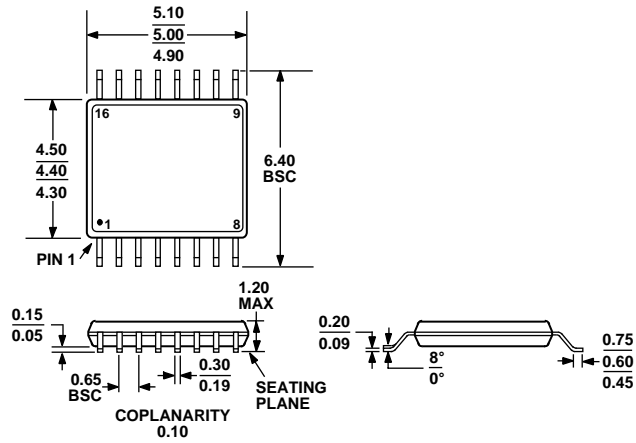

COMPLIANT TO JEDEC STANDARDS MO-153-AB

Figure 79. 16-Lead Thin Shrink Small Outline Package [TSSOP]  
(RU-16)

Dimensions shown in millimeters



## AD5629R ORDERING GUIDE

Model	Temperature Range	Package Description	Package Option	Power-On Reset to Code	Accuracy
AD5629RACPZ <sup>1</sup>	-40°C to +105°C	16-Lead LFCSP	CP-16-17	Zero	±2 LSB INL
AD5629RBCPZ <sup>1</sup>	-40°C to +105°C	16-Lead LFCSP	CP-16-17	Zero	±1 LSB INL
AD5629RARUZ <sup>1</sup>	-40°C to +105°C	16-Lead TSSOP	RU-16	Zero	±2 LSB INL
AD5629RBRUZ <sup>1</sup>	-40°C to +105°C	16-Lead TSSOP	RU-16	Zero	±1 LSB INL

<sup>1</sup> Z = Pb-free part.

## AD5669R ORDERING GUIDE

Model	Temperature Range	Package Description	Package Option	Power-On Reset to Code	Accuracy
AD5669RACPZ <sup>1</sup>	-40°C to +105°C	16-Lead LFCSP	CP-16-17	Zero	±32 LSB INL
AD5669RACPZ-3 <sup>1</sup>	-40°C to +105°C	16-Lead LFCSP	CP-16-17	Midscale	±32 LSB INL
AD5669RBCPZ <sup>1</sup>	-40°C to +105°C	16-Lead LFCSP	CP-16-17	Zero	±16 LSB INL
AD5669RARUZ <sup>1</sup>	-40°C to +105°C	16-Lead TSSOP	RU-16	Zero	±32 LSB INL
AD5669RARUZ-3 <sup>1</sup>	-40°C to +105°C	16-Lead TSSOP	RU-16	Midscale	±32 LSB INL
AD5669RBRUZ <sup>1</sup>	-40°C to +105°C	16-Lead TSSOP	RU-16	Zero	±16 LSB INL
EVAL-AD5669REBZ-RU		LFCSP Evaluation board			
EVAL-AD5669REBZ-CP		TSSOP Evaluation board			

<sup>1</sup> Z = Pb-free part.