

Features

- 2.8A, 20V, $R_{DS(on)}$ (Max 65m Ω)@ $V_{GS}=-4.5V$
- 1.2 V Rated for Low Voltage Gate Drive
- SOT-23 Surface Mount for Small Footprint
- Single Pulse Avalanche Energy Rated
- Halogen-free

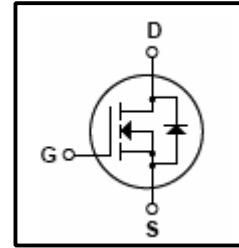

General Description

This Power MOSFET is produced using Winsemi's advanced MOS technology. This latest technology has been especially designed to minimize on-state resistance, have a high rugged avalanche characteristics. This devices is specially well suited for Load switching and PA switching.

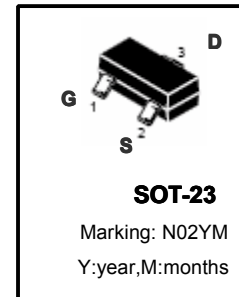

Absolute Maximum Ratings($T_c=25^{\circ}C$ unless otherwise noted)

Symbol	Parameter	Value	Units
V_{DSS}	Drain Source Voltage	20	V
I_D	Continuous Drain Current	2.8	A
I_{DM}	Drain Current Pulsed	8	A
P_D	Total Power Dissipation(Note 1)	0.9	W
		$T_c=75^{\circ}C$	
V_{GS}	Gate to Source Voltage	± 8	V
ESD	ESD Capability (Note 3)	$C=100pF, R_s = 1500\Omega$	225 V
T_J, T_{stg}	Junction and Storage Temperature	-55~150	$^{\circ}C$
T_L	Maximum lead Temperature for soldering purposes	260	$^{\circ}C$

Maximum ratings are those values beyond which device damage can occur. Maximum ratings applied to the device are individual stress limit values (not normal operating conditions) and are not valid simultaneously. If these limits are exceeded, device functional operation is not implied, damage may occur and reliability may be affected.

Thermal Characteristics

Symbol	Parameter	Value			Units
		Min	Typ	Max	
R_{QJA}	Thermal Resistance, Junction-to-Ambient(Note 1)	-	-	170	$^{\circ}C/W$
R_{QJA}	Thermal Resistance, Junction-to-Ambient(Note 1)			110	$^{\circ}C/W$
R_{QJA}	Thermal Resistance, Junction-to-Ambient(Note 2)			300	$^{\circ}C/W$

Note 1: Surface-mounted on FR4 board using 1 in sq pad size (Cu area = 1.127 in sq [1 oz] including traces)
 Note 2: Surface-mounted on FR4 board using the minimum recommended pad size.
 Note 3: ESD Rating Information: HBM Class 0

Electrical Characteristics (T_c = 25°C)

Characteristics		Symbol	Test Condition	Min	Type	Max	Unit
Gate leakage current(Note 4)		I _{GSS}	V _{GS} = ±8 V, V _{DS} = 0 V	-	-	±100	nA
Drain cut-off current(Note 4)		I _{DSS}	V _{DS} = 16 V, V _{GS} = 0 V	-	-	-1	μA
Drain-source breakdown voltage		V _{(BR)DSS}	I _D = 250 μA, V _{GS} = 0 V	20	-	-	V
Gate threshold voltage		V _{GS(th)}	V _{DS} = V _{DS} I _D = 250 μA	0.65	-	1.2	V
Drain-source ON resistance		R _{DS(ON)}	V _{GS} = 4.5 V, I _D = 2.8 A	-	40	65	mΩ
			V _{GS} = 2.5 V, I _D = 2.0 A		50	95	
Forward Transconductance		g _{fs}	V _{DS} = 5.0 V, I _D = 2.8 A	-	6.5	-	S
Input capacitance		C _{iss}	V _{DS} = 6 V,	-	428	-	pF
Reverse transfer capacitance		C _{rss}	V _{GS} = 0 V,	-	57	-	
Output capacitance		C _{oss}	f = 1 MHz	-	80	-	
Switching time (Note 5)	Turn-on Delay time	t _{d(on)}	V _{GS} = 4.5 V,	-	6.2	-	ns
	Turn-on Rise time	t _r	V _{DS} = 6.0 V,	-	7.5	-	
	Turn-off Delay time	t _{d(off)}	I _D = 1.0 A,	-	16.0	-	
	Turn-off Fall time	t _f	R _G = 6 Ω, R _L = 10 Ω	-	4.2	-	
Total gate charge		Q _g	V _{GS} = 4.5V,	-	7.5	8.5	nC
Gate-source charge		Q _{gs}	V _{DS} = 6 V,	-	1.2	-	
Gate-drain ("miller") Charge		Q _{gd}	I _D = 2.8 A	-	2.2	-	

Source-Drain Ratings and Characteristics (T_a = 25°C)

Characteristics	Symbol	Test Condition	Min	Type	Max	Unit
Continuous drain reverse current	I _{DR}	-	-	-	2.8	A
Pulse drain reverse current	I _{DRP}	-	-	-	8.0	A
Forward voltage (diode)	V _{DSF}	I _{DR} = 1.6A, V _{GS} = 0 V	-	0.76	1.2	V

Note 4: Pulse Test: Pulse Width ≤300μs, Duty Cycle 3 2%.

Note 5: Switching characteristics are independent of operating junction temperature.

This transistor is an electrostatic sensitive device

Please handle with caution

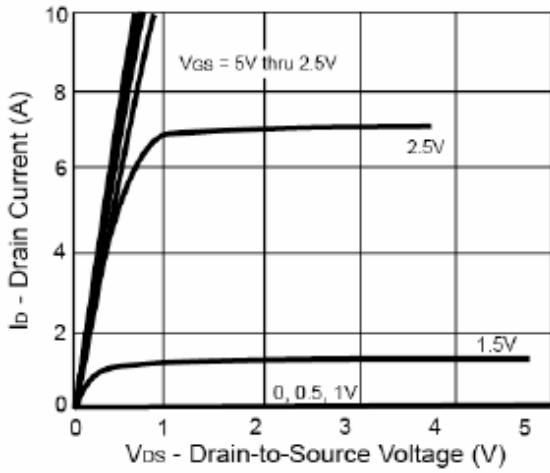

Fig. 1 On-State Characteristics

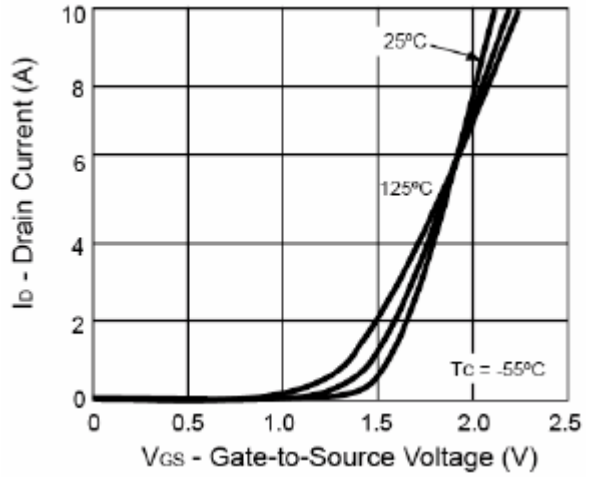

Fig. 2 Transfer Current Characteristics

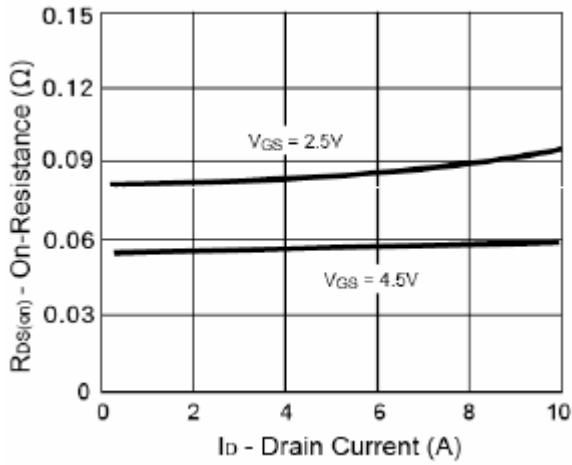

Fig. 3 On-Resistance vs. Drain Current

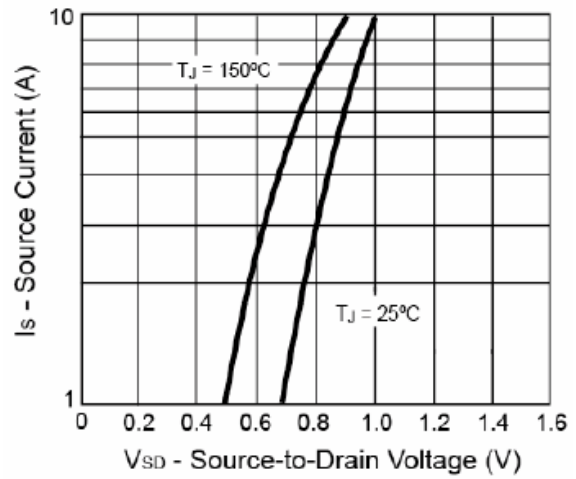

Fig. 4 Diode Forward Voltage vs. Current

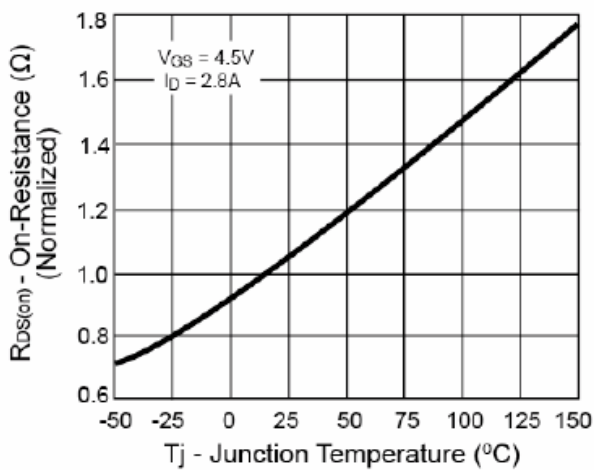

Fig. 5 On-Resistance Variation vs. Junction Temperature

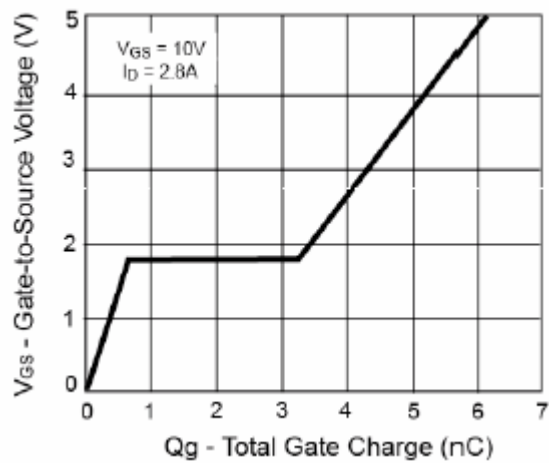

Fig. 6 Gate Charge Characteristics

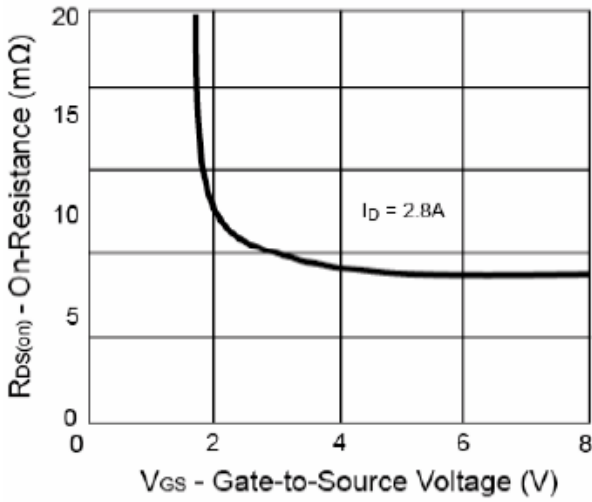

Fig.7 On-Resistance vs. Gate-Source Voltage

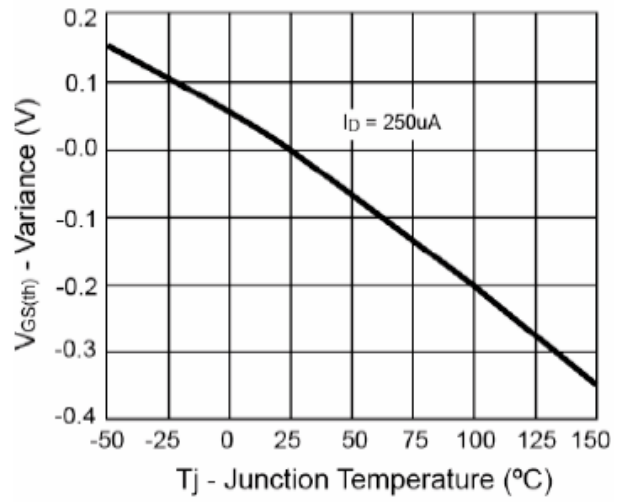

Fig.8 Threshold Voltage

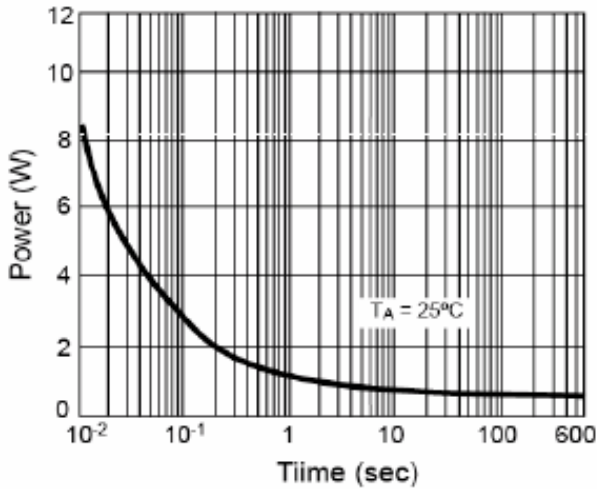

Fig.9 Single Pulse Power

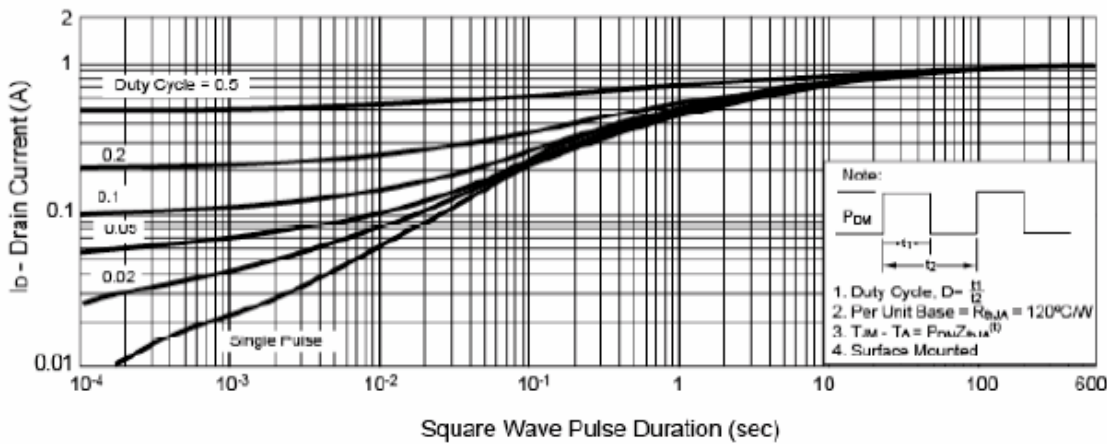

Fig.10 Drain Current and Temperature

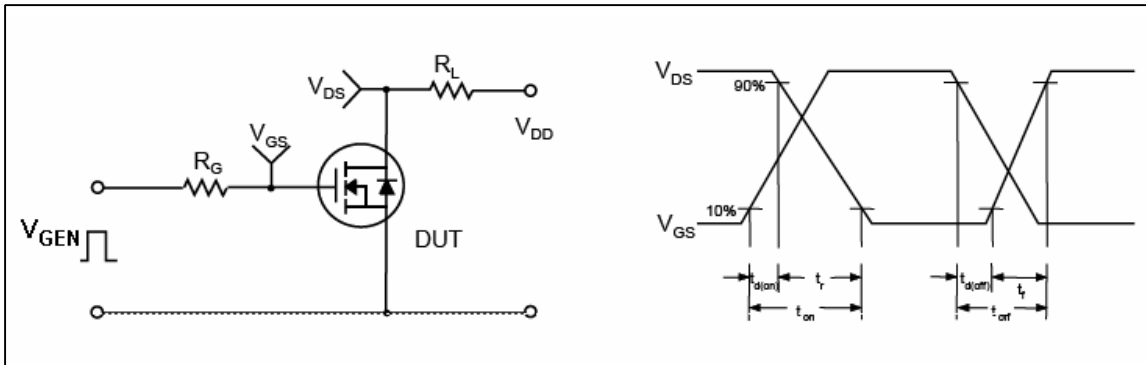

Fig.11 Resistive Switching Test & Waveforms

SOT-23 Package Dimension

DIM	MILLIMETERS		INCHES	
	MIN	MAX	MIN	MAX
A	0.95		0.037	
A1	1.90		0.074	
B	2.60	3.00	0.102	0.118
C	1.40	1.70	0.055	0.067
D	2.80	3.10	0.110	0.122
E	1.00	1.30	0.039	0.051
F	0.00	0.10	0.000	0.004
G	0.35	0.50	0.014	0.020
H	0.10	0.20	0.004	0.008
I	0.30	0.60	0.012	0.024
J	50°	10°	50°	10°

