

Compliance with RoHS Directive

FEATURES

1. Super miniature design

14 × 8.6 × 7.2 mm .551 × .339 × .283 inch
(standard PC board terminal)

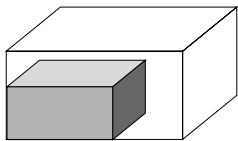

60% OFF in volume
(Compared to
RK relay)

2. Lineup includes silent type. (75Ω type only)

Operation noise (Unit: dB)

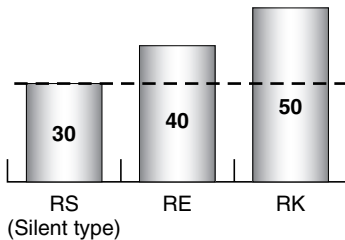

3. Excellent high frequency characteristics

- Impedance: 50Ω
(Standard PC board terminal)

Frequency	to 900 MHz	to 3 GHz
V. S. W. R. (Max.)	1.20	1.40
Insertion loss (dB, Max.)	0.10	0.35
Isolation (dB, Min.)	60	35

- Impedance: 75Ω
(Standard PC board terminal)

Frequency	to 900 MHz	to 3 GHz
V. S. W. R. (Max.)	1.15	1.40
Insertion loss (dB, Max.)	0.10	0.30
Isolation (dB, Min.)	60	30

- Impedance: 50Ω
(Surface-mount terminal)

Frequency	to 900 MHz	to 3 GHz
V. S. W. R. (Max.)	1.20	1.40
Insertion loss (dB, Max.)	0.20	0.40
Isolation (dB, Min.)	55	30

- Impedance: 75Ω
(Surface-mount terminal)

Frequency	to 900 MHz	to 3 GHz
V. S. W. R. (Max.)	1.20	1.50
Insertion loss (dB, Max.)	0.20	0.50
Isolation (dB, Min.)	55	30

4. Lineup includes surface-mount terminal type

E and Y layouts available.

5. Lineup includes reversed contact type

Great design freedom is possible using reversed contact type in which the positions of the N.O. and N.C. contacts are switched.

TYPICAL APPLICATIONS

1. Broadcasting and video equipment markets

- Digital broadcasting equipment
- STB/tuner, etc.

2. Mobile phone base stations

3. Communications market

- Antenna switching
- All types of wireless devices

4. Measurement equipment market

- Spectrum analyzer and oscilloscope, etc.

If you wish to use in applications with low level loads or with high frequency switching, please consult us.

ORDERING INFORMATION

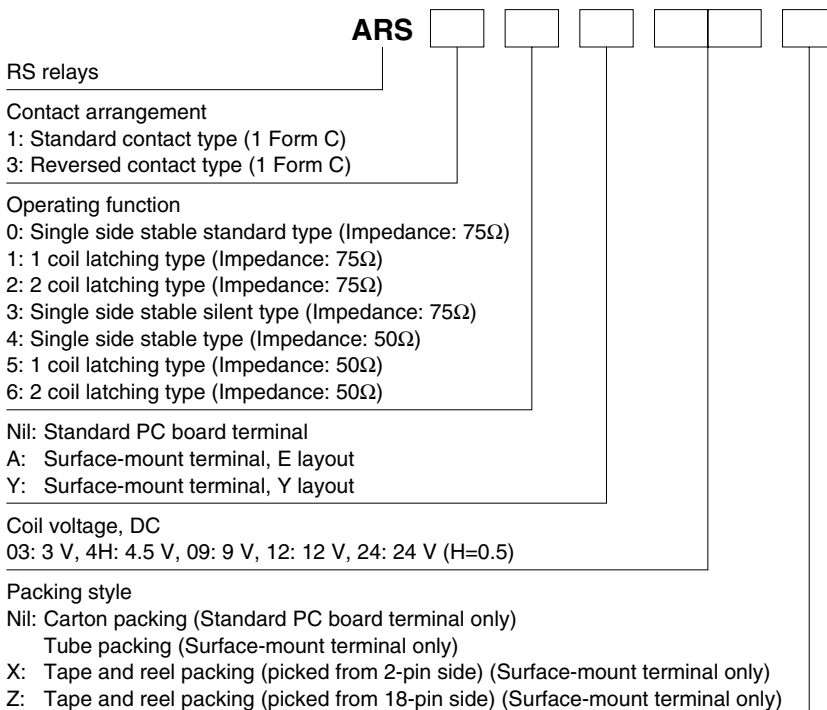

RS (ARS)

TYPES

1. Standard PC board terminal and standard contact type

Impedance	Nominal coil voltage	Part No.		
		Single side stable type	1 coil latching type	2 coil latching type
50Ω	3 V DC	ARS1403	ARS1503	ARS1603
	4.5 V DC	ARS144H	ARS154H	ARS164H
	9 V DC	ARS1409	ARS1509	ARS1609
	12 V DC	ARS1412	ARS1512	ARS1612
	24 V DC	ARS1424	ARS1524	ARS1624

Impedance	Nominal coil voltage	Part No.			
		Standard type			Silent type
		Single side stable type	1 coil latching type	2 coil latching type	Single side stable type
75Ω	3 V DC	ARS1003	ARS1103	ARS1203	ARS1303
	4.5 V DC	ARS104H	ARS114H	ARS124H	ARS134H
	9 V DC	ARS1009	ARS1109	ARS1209	ARS1309
	12 V DC	ARS1012	ARS1112	ARS1212	ARS1312
	24 V DC	ARS1024	ARS1124	ARS1224	ARS1324

Standard packing: 50 pcs. in an inner package; 500 pcs. in an outer package

2. Standard PC board terminal and reversed contact type

Impedance	Nominal coil voltage	Part No.		
		Single side stable type	1 coil latching type	2 coil latching type
50Ω	3 V DC	ARS3403	ARS3503	ARS3603
	4.5 V DC	ARS344H	ARS354H	ARS364H
	9 V DC	ARS3409	ARS3509	ARS3609
	12 V DC	ARS3412	ARS3512	ARS3612
	24 V DC	ARS3424	ARS3524	ARS3624

Impedance	Nominal coil voltage	Part No.			
		Standard type			Silent type
		Single side stable type	1 coil latching type	2 coil latching type	Single side stable type
75Ω	3 V DC	ARS3003	ARS3103	ARS3203	ARS3303
	4.5 V DC	ARS304H	ARS314H	ARS324H	ARS334H
	9 V DC	ARS3009	ARS3109	ARS3209	ARS3309
	12 V DC	ARS3012	ARS3112	ARS3212	ARS3312
	24 V DC	ARS3024	ARS3124	ARS3224	ARS3324

Standard packing: 50 pcs. in an inner package; 500 pcs. in an outer package

3. Surface-mount terminal and standard contact type, E layout

Impedance	Nominal coil voltage	Part No.		
		Single side stable type	1 coil latching type	2 coil latching type
50Ω	3 V DC	ARS14A03□	ARS15A03□	ARS16A03□
	4.5 V DC	ARS14A4H□	ARS15A4H□	ARS16A4H□
	9 V DC	ARS14A09□	ARS15A09□	ARS16A09□
	12 V DC	ARS14A12□	ARS15A12□	ARS16A12□
	24 V DC	ARS14A24□	ARS15A24□	ARS16A24□
75Ω	3 V DC	ARS10A03□	ARS11A03□	ARS12A03□
	4.5 V DC	ARS10A4H□	ARS11A4H□	ARS12A4H□
	9 V DC	ARS10A09□	ARS11A09□	ARS12A09□
	12 V DC	ARS10A12□	ARS11A12□	ARS12A12□
	24 V DC	ARS10A24□	ARS11A24□	ARS12A24□

Standard packing: 40 pcs. in an inner package (tube); 1,000 pcs. in an outer package

Standard packing: 500 pcs. in an inner package (tape and reel); 1,000 pcs. in an outer package

Note: The box at the end of a part number shows where packing type is indicated. If there is no indication, tube packing will be used.

If "X" or "Z" is added, tape and reel packing will be used. Example: ARS14A03 (tube packing), ARS14A03X (tape and reel packing)

4. Surface-mount terminal and standard contact type, Y layout

Impedance	Nominal coil voltage	Part No.		
		Single side stable type	1 coil latching type	2 coil latching type
50Ω	3 V DC	ARS14Y03□	ARS15Y03□	ARS16Y03□
	4.5 V DC	ARS14Y4H□	ARS15Y4H□	ARS16Y4H□
	9 V DC	ARS14Y09□	ARS15Y09□	ARS16Y09□
	12 V DC	ARS14Y12□	ARS15Y12□	ARS16Y12□
	24 V DC	ARS14Y24□	ARS15Y24□	ARS16Y24□
75Ω	3 V DC	ARS10Y03□	ARS11Y03□	ARS12Y03□
	4.5 V DC	ARS10Y4H□	ARS11Y4H□	ARS12Y4H□
	9 V DC	ARS10Y09□	ARS11Y09□	ARS12Y09□
	12 V DC	ARS10Y12□	ARS11Y12□	ARS12Y12□
	24 V DC	ARS10Y24□	ARS11Y24□	ARS12Y24□

Standard packing: 40 pcs. in an inner package (tube); 1,000 pcs. in an outer package

Standard packing: 500 pcs. in an inner package (tape and reel); 1,000 pcs. in an outer package

Note: The box at the end of a part number shows where packing type is indicated. If there is no indication, tube packing will be used.

If "X" or "Z" is added, tape and reel packing will be used. Example: ARS14Y03 (tube packing), ARS14Y03X (tape and reel packing)

5. Surface-mount terminal and reversed contact type, E layout

Impedance	Nominal coil voltage	Part No.		
		Single side stable type	1 coil latching type	2 coil latching type
50Ω	3 V DC	ARS34A03□	ARS35A03□	ARS36A03□
	4.5 V DC	ARS34A4H□	ARS35A4H□	ARS36A4H□
	9 V DC	ARS34A09□	ARS35A09□	ARS36A09□
	12 V DC	ARS34A12□	ARS35A12□	ARS36A12□
	24 V DC	ARS34A24□	ARS35A24□	ARS36A24□
75Ω	3 V DC	ARS30A03□	ARS31A03□	ARS32A03□
	4.5 V DC	ARS30A4H□	ARS31A4H□	ARS32A4H□
	9 V DC	ARS30A09□	ARS31A09□	ARS32A09□
	12 V DC	ARS30A12□	ARS31A12□	ARS32A12□
	24 V DC	ARS30A24□	ARS31A24□	ARS32A24□

Standard packing: 40 pcs. in an inner package (tube); 1,000 pcs. in an outer package

Standard packing: 500 pcs. in an inner package (tape and reel); 1,000 pcs. in an outer package

Note: The box at the end of a part number shows where packing type is indicated. If there is no indication, tube packing will be used.

If "X" or "Z" is added, tape and reel packing will be used. Example: ARS34A03 (tube packing), ARS34A03X (tape and reel packing)

6. Surface-mount terminal and reversed contact type, Y layout

Impedance	Nominal coil voltage	Part No.		
		Single side stable type	1 coil latching type	2 coil latching type
50Ω	3 V DC	ARS34Y03□	ARS35Y03□	ARS36Y03□
	4.5 V DC	ARS34Y4H□	ARS35Y4H□	ARS36Y4H□
	9 V DC	ARS34Y09□	ARS35Y09□	ARS36Y09□
	12 V DC	ARS34Y12□	ARS35Y12□	ARS36Y12□
	24 V DC	ARS34Y24□	ARS35Y24□	ARS36Y24□
75Ω	3 V DC	ARS30Y03□	ARS31Y03□	ARS32Y03□
	4.5 V DC	ARS30Y4H□	ARS31Y4H□	ARS32Y4H□
	9 V DC	ARS30Y09□	ARS31Y09□	ARS32Y09□
	12 V DC	ARS30Y12□	ARS31Y12□	ARS32Y12□
	24 V DC	ARS30Y24□	ARS31Y24□	ARS32Y24□

Standard packing: 40 pcs. in an inner package (tube); 1,000 pcs. in an outer package

Standard packing: 500 pcs. in an inner package (tape and reel); 1,000 pcs. in an outer package

Note: The box at the end of a part number shows where packing type is indicated. If there is no indication, tube packing will be used.

If "X" or "Z" is added, tape and reel packing will be used. Example: ARS34Y03 (tube packing), ARS34Y03X (tape and reel packing)

RATING

1. Coil data

1) Single side stable type

Nominal coil voltage	Pick-up voltage (at 20°C 68°F)	Drop-out voltage (at 20°C 68°F)	Nominal operating current [±10%] (at 20°C 68°F)	Coil resistance [±10%] (at 20°C 68°F)	Nominal operating power	Max. applied voltage (at 60°C 140°F)
3 V DC	75%V or less of nominal voltage (Initial)	10%V or more of nominal voltage (Initial)	66.7 mA	45 Ω	200 mW	110%V or less of nominal voltage
4.5 V DC			44.4 mA	101.3Ω		
9 V DC			22.2 mA	405 Ω		
12 V DC			16.7 mA	720 Ω		
24 V DC			8.3 mA	2,880 Ω		

2) 1 coil latching type

Nominal coil voltage	Set voltage (at 20°C 68°F)	Reset voltage (at 20°C 68°F)	Nominal operating current [±10%] (at 20°C 68°F)	Coil resistance [±10%] (at 20°C 68°F)	Nominal operating power	Max. applied voltage (at 60°C 140°F)
3 V DC	75%V or less of nominal voltage (Initial)	75%V or less of nominal voltage (Initial)	66.7 mA	45 Ω	200 mW	110%V or less of nominal voltage
4.5 V DC			44.4 mA	101.3Ω		
9 V DC			22.2 mA	405 Ω		
12 V DC			16.7 mA	720 Ω		
24 V DC			8.3 mA	2,880 Ω		

3) 2 coil latching type

Nominal coil voltage	Set voltage (at 20°C 68°F)	Reset voltage (at 20°C 68°F)	Nominal operating current [±10%] (at 20°C 68°F)	Coil resistance [±10%] (at 20°C 68°F)	Nominal operating power	Max. applied voltage (at 60°C 140°F)
3 V DC	75%V or less of nominal voltage (Initial)	75%V or less of nominal voltage (Initial)	133.3 mA	22.5Ω	400 mW	110%V or less of nominal voltage
4.5 V DC			88.9 mA	50.6Ω		
9 V DC			44.4 mA	202.5Ω		
12 V DC			33.3 mA	360 Ω		
24 V DC			16.7 mA	1,440 Ω		

RS (ARS)

2. Specifications

Item		Specifications	
Contact	Arrangement	1 Form C	
	Contact material	Gold plating	
	Contact resistance (Initial)	Max. 100 mΩ (By voltage drop 10 V AC 10mA)	
Rating	Nominal switching capacity	1W (at 3 GHz, Impedance: 50/75Ω, V.S.W.R.: Max. 1.4), 10 mA 24 V DC (resistive load)	
	Contact carrying power	Max. 10W (at 3GHz, Impedance: 50/75Ω, V.S.W.R.: Max. 1.4)	
	Max. switching voltage	30 V DC	
	Max. switching current	0.5 A DC	
	Nominal operating power	Single side stable type	200mW
		1 coil latching type	200mW
2 coil latching type		400mW	
High frequency characteristics, Impedance: 50Ω (Initial)	V.S.W.R.	Max. 1.20/900MHz, Max. 1.40/3GHz (Standard PC board terminal) Max. 1.20/900MHz, Max. 1.40/3GHz (Surface-mount terminal)	
	Insertion loss (without D.U.T. board's loss)	Max. 0.10dB/900MHz, Max. 0.35dB/3GHz (Standard PC board terminal) Max. 0.20dB/900MHz, Max. 0.40dB/3GHz (Surface-mount terminal)	
	Isolation	Min. 60dB/900MHz, Min. 35dB/3GHz (Standard PC board terminal) Min. 55dB/900MHz, Min. 30dB/3GHz (Surface-mount terminal)	
High frequency characteristics, Impedance: 75Ω (Initial)	V.S.W.R.	Max. 1.15/900MHz, Max. 1.40/3GHz (Standard PC board terminal) Max. 1.20/900MHz, Max. 1.50/3GHz (Surface-mount terminal)	
	Insertion loss (without D.U.T. board's loss)	Max. 0.10dB/900MHz, Max. 0.30dB/3GHz (Standard PC board terminal) Max. 0.20dB/900MHz, Max. 0.50dB/3GHz (Surface-mount terminal)	
	Isolation	Min. 60dB/900MHz, Min. 30dB/3GHz (Standard PC board terminal) Min. 55dB/900MHz, Min. 30dB/3GHz (Surface-mount terminal)	
Electrical characteristics	Insulation resistance (Initial)	Min. 100MΩ (at 500V DC, Measurement at same location as "Breakdown voltage" section.)	
	Breakdown voltage (Initial)	Between open contacts	500 Vrms for 1min. (Detection current: 10mA)
		Between contact and earth terminal	500 Vrms for 1min. (Detection current: 10mA)
		Between contact and coil	1,000 Vrms for 1min. (Detection current: 10mA)
	Temperature rise (at 20°C 68°F)	Max. 60°C 140°F (By resistive method, nominal voltage applied to the coil, contact carrying current: 10mA)	
	Operate time (at 20°C 68°F)	Max. 10 ms (Nominal voltage applied to the coil, excluding contact bounce time)	
	Release time (at 20°C 68°F)	Max. 6 ms (Nominal voltage applied to the coil, excluding contact bounce time) (without diode)	
Set time and Reset time (at 20°C 68°F)	Max. 10 ms (Nominal voltage applied to the coil, excluding contact bounce time)		
Mechanical characteristics	Shock resistance	Functional	Min. 196 m/s ² (Half-wave pulse of sine wave: 11 ms, detection time: 10μs)
		Destructive	Min. 980 m/s ² (Half-wave pulse of sine wave: 6 ms)
	Vibration resistance	Functional	10 to 55 Hz at double amplitude of 3 mm (Detection time: 10μs)
		Destructive	10 to 55 Hz at double amplitude of 5 mm
Operation noise*	Standard type	Approx. 40dB	
	Silent type (75Ω, PC board terminal type only)	Approx. 30dB	
Expected life	Mechanical life	Single side stable standard type	Min. 5×10 ⁶ (at 180 cpm)
		Single side stable silent type	Min. 10 ⁶ (at 180 cpm)
		Latching type	Min. 10 ⁶ (at 180 cpm)
	Electrical life	50Ω type	Min. 10 ⁶ (Standard PC board terminal), Min. 3×10 ⁵ (Surface-mount terminal) (10V DC 10mA resistive load)/Min. 3×10 ⁵ (24V DC 10mA resistive load) Min. 10 ⁶ (Standard PC board terminal), Min. 3×10 ⁵ (Surface-mount terminal) (1W, at 3GHz, Impedance: 50Ω, V.S.W.R: Max. 1.4) (at 20 cpm)
75Ω type		Min. 3×10 ⁵ (10mA 24V DC resistive load) Min. 3×10 ⁵ (1W, at 3GHz, Impedance: 75Ω, V.S.W.R: Max. 1.4) (at 20 cpm)	
Conditions	Conditions for operation, transport and storage	Ambient temperature: -40 to 70°C -40°F to 158°F (Single side stable standard and Latching type) Ambient temperature: -40 to 60°C -40°F to 140°F (Single side stable silent type) Humidity: 5 to 85% R.H. (Not freezing and condensing at low temperature)	
Unit weight		Approx. 2 g .071 oz	

* Measured the operation noise of the relay alone (with diodes at both ends of the coil) 30cm away from top side, by the A-weighted, FAST method while applying the rated voltage.

(Reference) Operation noise of RK relay (existing model): Approx. 50dB

REFERENCE DATA

1.-(1) High frequency characteristics (Impedance: 50Ω, Standard PC board terminal)

Sample: ARS144H; Measuring method: Measured with Agilent Technologies network analyzer (E8363B). *For details see No. 7 under "NOTES".

• V.S.W.R. characteristics

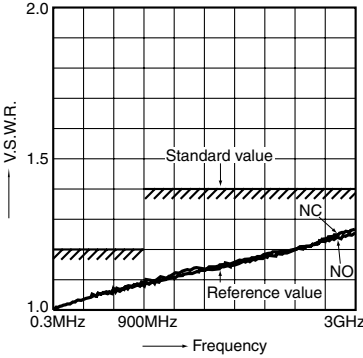

• Insertion loss characteristics (without D.U.T. board's loss)

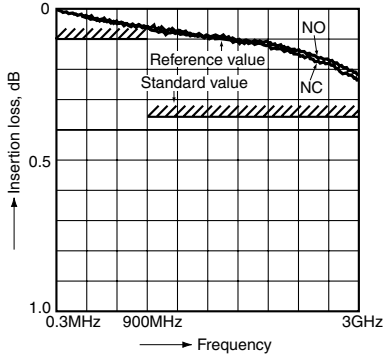

• Isolation characteristics

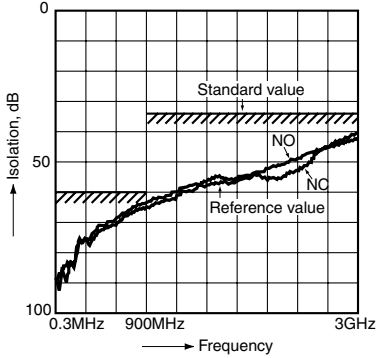

1.-(2) High frequency characteristics (Impedance: 75Ω, Standard PC board terminal)

Sample: ARS104H; Measuring method: Measured with Agilent Technologies network analyzer (E8363B). *For details see No. 7 under "NOTES".

• V.S.W.R. characteristics

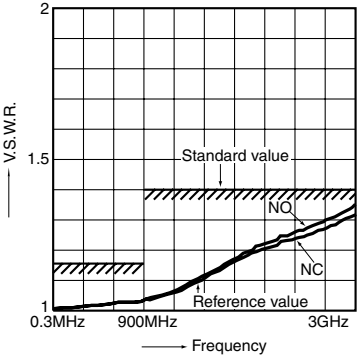

• Insertion loss characteristics (without D.U.T. board's loss)

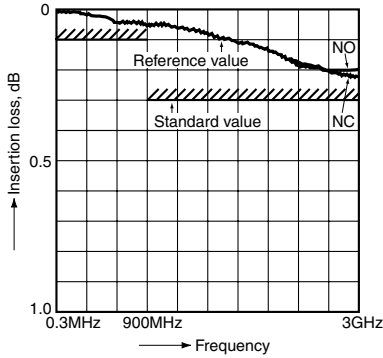

• Isolation characteristics

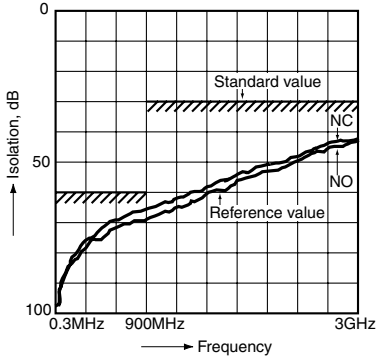

1.-(3) High frequency characteristics (Impedance: 50Ω, Surface-mount terminal)

Sample: ARS14A4H; Measuring method: Measured with Agilent Technologies network analyzer (E8363B). *For details see No. 7 under "NOTES".

• V.S.W.R. characteristics

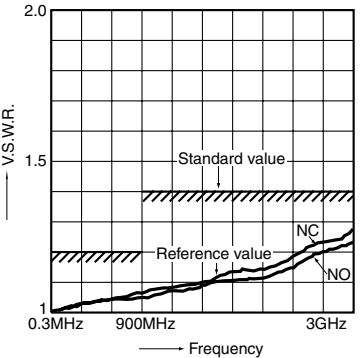

• Insertion loss characteristics (without D.U.T. board's loss)

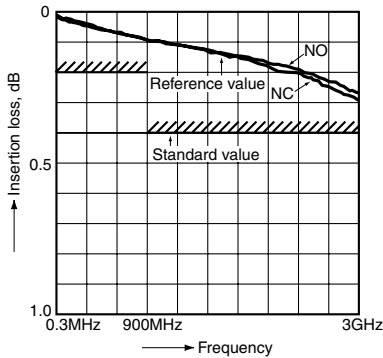

• Isolation characteristics

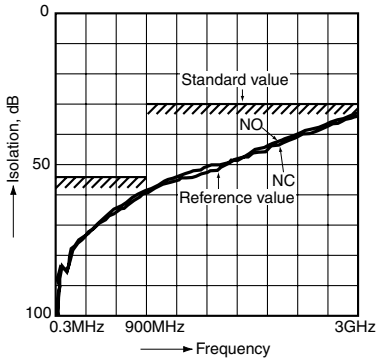

1.-(4) High frequency characteristics (Impedance: 75Ω, Surface-mount terminal)

Sample: ARS10A4H; Measuring method: Measured with Agilent Technologies network analyzer (E8363B). *For details see No. 7 under "NOTES".

• V.S.W.R. characteristics

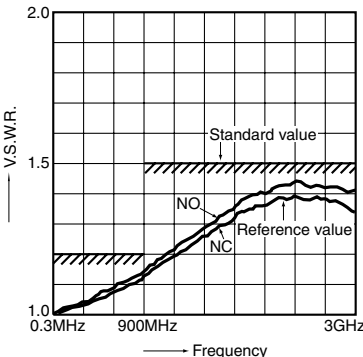

• Insertion loss characteristics (without D.U.T. board's loss)

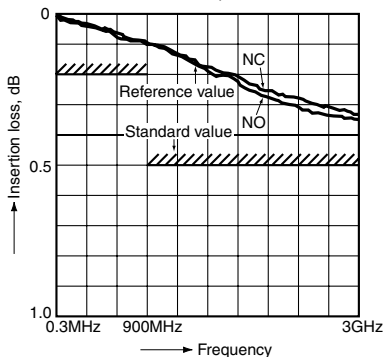

• Isolation characteristics

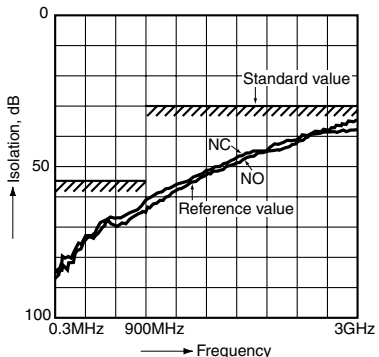

RS (ARS)

2.-(1) Operation noise distribution

Sample: ARS134H (single side stable silent type), 50 pcs.
 Coil voltage: rated voltage applied (with diode)
 Equipment setting: A weighted sound pressure level, FAST.
 Background noise: approx. 20 dB
 Method of measurement: See figure below.

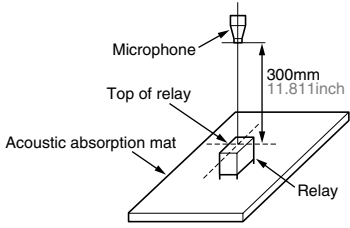

When operated

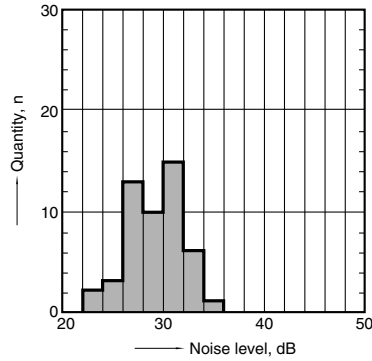

When released

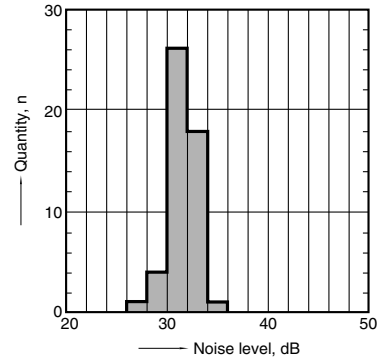

2.-(2) Operation noise distribution

Sample: ARS104H (single side stable standard type), 50 pcs.
 Coil voltage: rated voltage applied (with diode)
 Equipment setting: A weighted sound pressure level, FAST.
 Background noise: approx. 20 dB
 Method of measurement: See figure below.

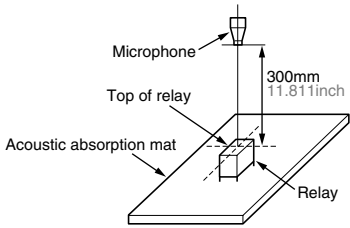

When operated

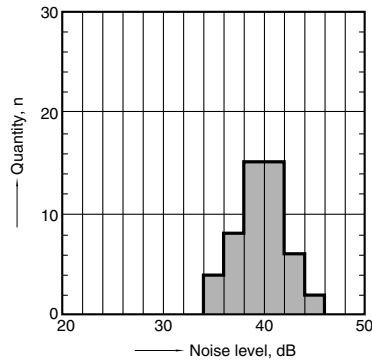

When released

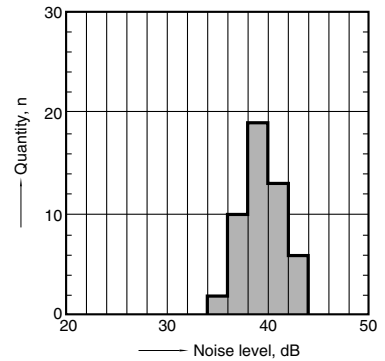

2.-(3) Operation noise distribution

Sample: ARS114H (latching type), 50 pcs.
 Coil voltage: rated voltage applied (with diode)
 Equipment setting: A weighted sound pressure level, FAST.
 Background noise: approx. 20 dB
 Method of measurement: See figure below.

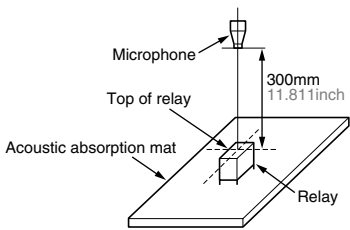

When set and reset

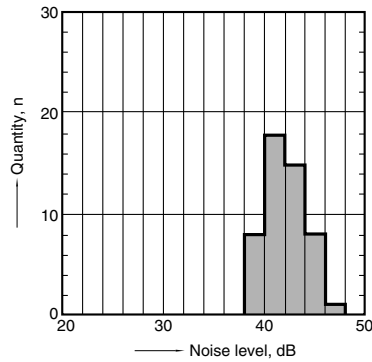

DIMENSIONS (mm inch)

<Standard PC board terminal>

1. 50Ω type

CAD Data



The CAD data of the products with a **CAD Data** mark can be downloaded from: <http://panasonic-electric-works.net/ac>

External dimensions

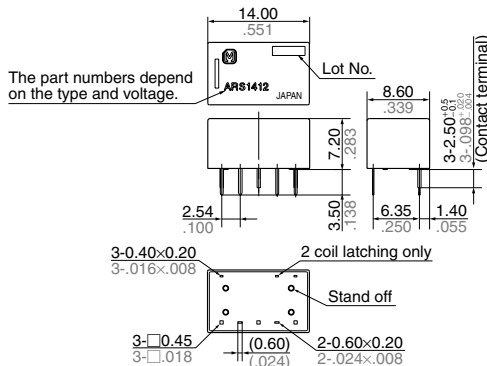

Tolerance: $\pm 0.3 \pm 0.12$

PC board pattern (Bottom view)

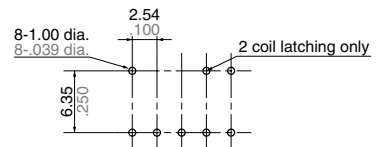

Tolerance: $\pm 0.1 \pm 0.04$

2. 75Ω type

CAD Data



External dimensions

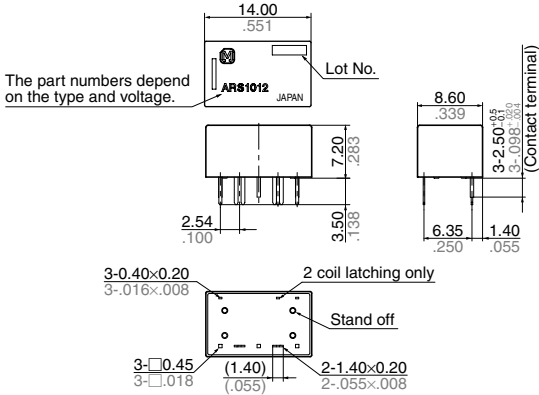

PC board pattern (Bottom view)

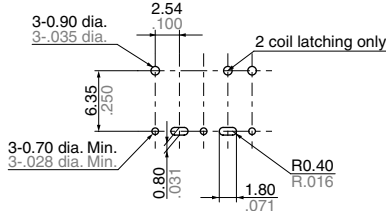

Tolerance: ±0.1 ±0.04

Tolerance: ±0.3 ±0.12

Schematic (Bottom view)

1. Standard contact type

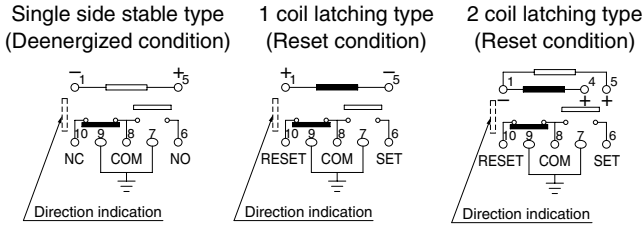

2. Reversed contact type

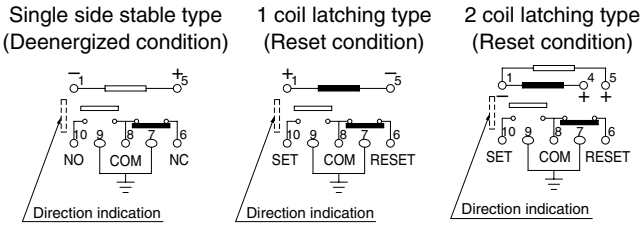

<Surface-mount terminal>

1. Impedance: 50Ω type

1) E layout



External dimensions

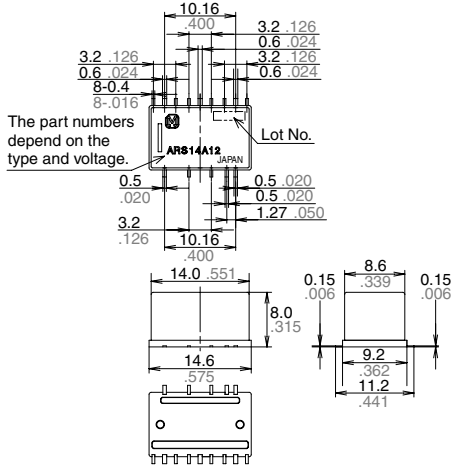

Tolerance: ±0.3 ±0.12

Schematic (Top view)

<Standard contact type>

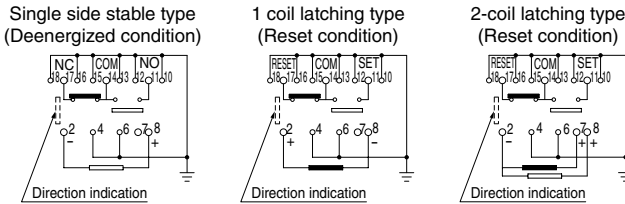

<Reversed contact type>

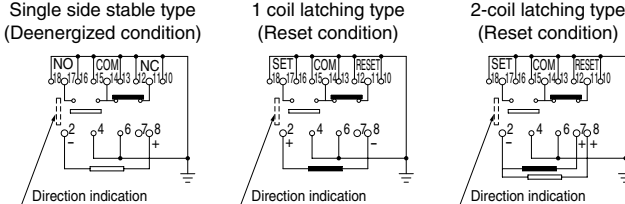

RS (ARS)

2) Y layout



External dimensions

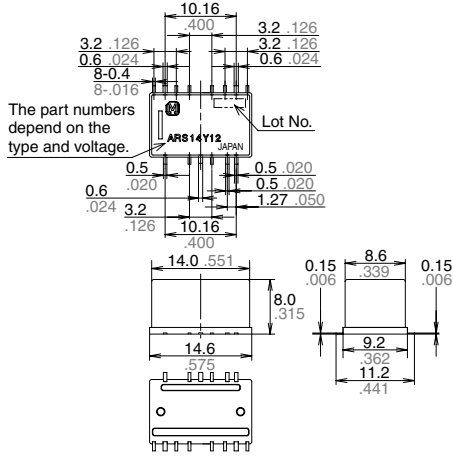

Tolerance: $\pm 0.3 \pm 0.12$

Schematic (Top view)

<Standard contact type>

Single side stable type
(Deenergized condition)

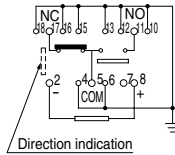

1 coil latching type
(Reset condition)

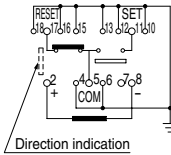

2-coil latching type
(Reset condition)

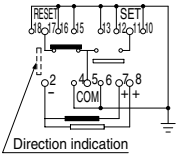

<Reversed contact type>

Single side stable type
(Deenergized condition)

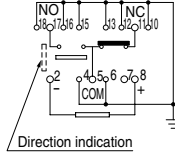

1 coil latching type
(Reset condition)

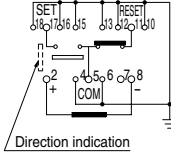

2-coil latching type
(Reset condition)

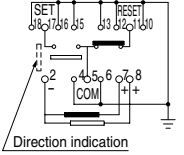

2. Impedance: 75Ω type

1) E layout



External dimensions

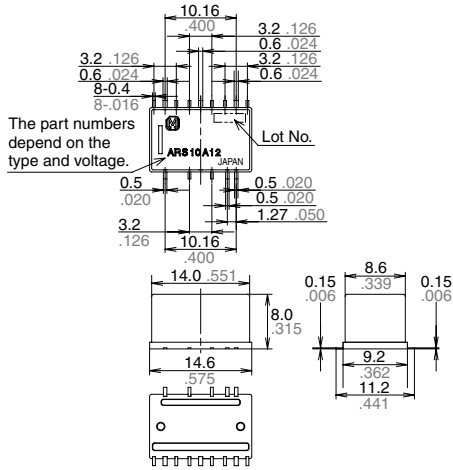

Tolerance: $\pm 0.3 \pm 0.12$

Schematic (Top view)

<Standard contact type>

Single side stable type
(Deenergized condition)

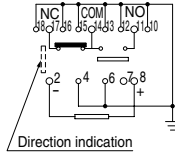

1 coil latching type
(Reset condition)

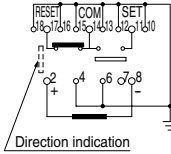

2-coil latching type
(Reset condition)

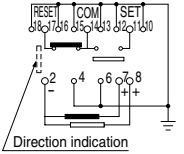

<Reversed contact type>

Single side stable type
(Deenergized condition)

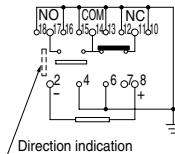

1 coil latching type
(Reset condition)

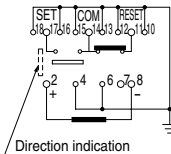

2-coil latching type
(Reset condition)

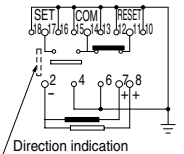

2) Y layout



External dimensions

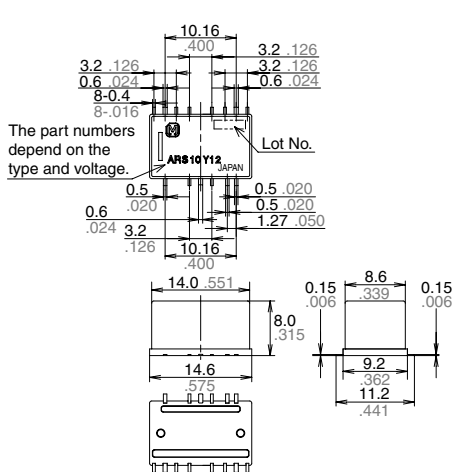

Tolerance: $\pm 0.3 \pm 0.12$

Schematic (Top view)

<Standard contact type>

Single side stable type
(Deenergized condition)

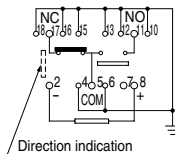

1 coil latching type
(Reset condition)

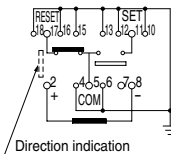

2-coil latching type
(Reset condition)

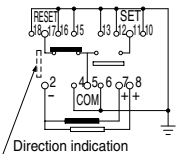

<Reversed contact type>

Single side stable type
(Deenergized condition)

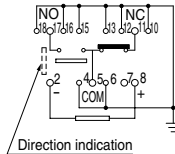

1 coil latching type
(Reset condition)

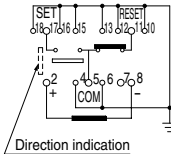

2-coil latching type
(Reset condition)

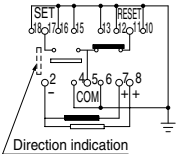

NOTES

1. Coil operating power

Pure DC current should be applied to the coil. The wave form should be rectangular. If it includes ripple, the ripple factor should be less than 5%. However, check it with the actual circuit since the characteristics may be slightly different. The nominal operating voltage should be applied to the coil for more than 30 ms to set/reset the latching type relay.

2. Coil connection

When connecting coils, refer to the wiring diagram to prevent mis-operation or malfunction.

3. External magnetic field

Since RS relays are highly sensitive polarized relays, their characteristics will be affected by a strong external magnetic field. Avoid using the relay under that condition.

4. Cleaning

For automatic cleaning, the boiling method is recommended. Avoid ultrasonic cleaning which subjects the relays to high frequency vibrations, which may cause the contacts to stick. It is recommended that alcoholic solvents be used.

5. Conditions for operation, transport and storage conditions

- 1) Temperature
 - Single side stable standard and latching type: -40 to 70°C -40 to 158°F
 - Single side stable silent type: -40 to 60°C -40 to 140°F
- 2) Humidity: 5 to 85% RH (Avoid freezing and condensation.) The humidity range varies with the temperature. Use within the range indicated in the graph below.
- 3) Atmospheric pressure: 86 to 106 kPa Temperature and humidity range for usage, transport, and storage: Single side stable standard and latching type

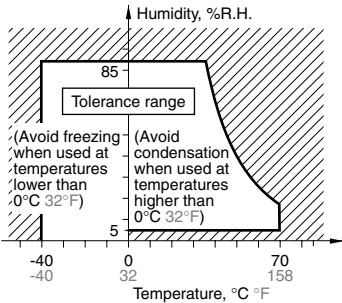

Single side stable silent type

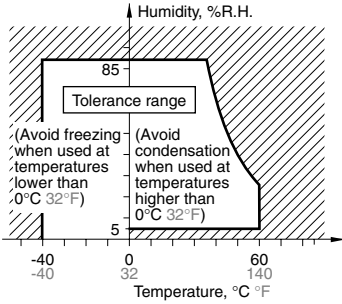

4) Condensation

Condensation forms when there is a sudden change in temperature under high temperature and high humidity conditions. Condensation will cause deterioration of the relay insulation.

5) Freezing

Condensation or other moisture may freeze on the relay when the temperature is lower than 0°C 32°F. This causes problems such as sticking of movable parts or operational time lags.

6) Low temperature, low humidity environments

The plastic becomes brittle if the relay is exposed to a low temperature, low humidity environment for long periods of time.

7) Storage requirements

Since the relay is sensitive to humidity, the surface-mount type is packaged with tightly sealed anti-humidity packaging. However, when storing, please be careful of the following.

- (1) Please use promptly once the anti-humidity pack is opened. If relays are left as is after unpacking, they will absorb moisture which will result in loss of air tightness as a result of case expansion due to thermal stress when reflow soldering during the mounting process. (within one day, 30°C and 60%R.H or less)
- (2) When storing for a long period after opening the anti-humidity pack, storage in anti-humidity packaging with an anti-humidity bag to which silica gel has been added, is recommended.

*Furthermore, if the relay is solder mounted when it has been subjected to excessive humidity, cracks and leaks can occur. Be sure to mount the relay under the required mounting conditions.

6. Soldering

- 1) Please meet the following conditions if this relay is to be automatically soldered.
 - (1) Preheating: Max. 120°C 248°F (terminal solder surface) for max. 120 seconds
 - (2) Soldering: Max. 260±5°C 500±9°F for max. 6 seconds

*Relays are influenced by the type of PC board used. Please confirm with the actual PC board you plan to use.
*Please avoid reflow soldering.

- 2) Surface-mount terminal In case of automatic soldering, the following conditions should be observed
 - (1) Position of measuring temperature

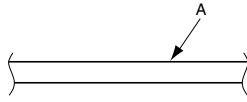

A: Surface of PC board where relay is mounted.

(2) IR (infrared reflow) soldering method

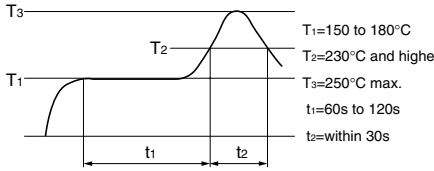

• Mounting cautions
Rise in relay temperature depends greatly on the component mix on a given PC board and the heating method of the reflow equipment. Therefore, please test beforehand using actual equipment to ensure that the temperature where the relay terminals are soldered and the temperature at the top of the relay case are within the conditions given above.

- 3) Please meet the following conditions if this relay is to be soldered by hand.
 - (1) 260°C 500°F for max. 10 seconds
 - (2) 350°C 662°F for max. 3 seconds
 The effect on the relay depends on the actual substrate used. Please verify the substrate to be used.
 - (3) Avoid ultrasonic cleaning. Doing so will adversely affect relay characteristics. Please use alcohol-based cleaning solvents when cleaning relays.

7. Tape and reel packing

1) Tape dimensions

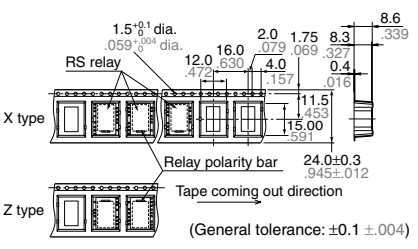

2) Dimensions of plastic reel

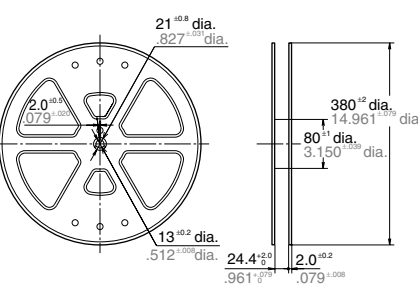

RS (ARS)

8. Measuring method

1) 50Ω type

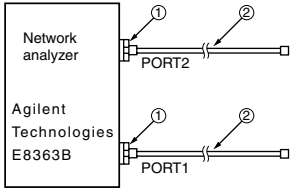

Connect connectors 1 and 2 respectively to PORT 1 and PORT 2. Perform calibration using the 3.5 mm calibration kit (HP85052B).

No.	Product name	Contents
1	Agilent 85130-60011	Adapter 2.4mm-3.5mm female .095inch-.138inch female
2	SUHNER SUCOFLEX104	Cable 3.5mm-3.5mm male .138inch-.138inch male

After calibration, connect the D.U.T. board and measure. However, connectors other than those for measurement should be connected with a 50Ω termination resistor.

<Standard PC board terminal>

PC board

Dimensions (mm inch)

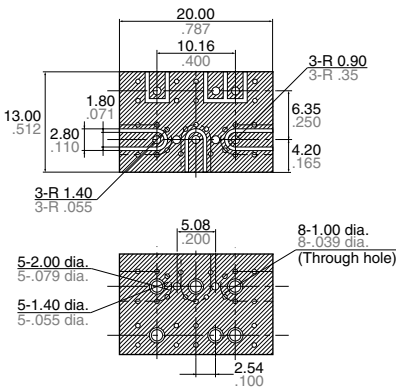

<Surface-mount terminal and E layout>

PC board

Dimensions (mm inch)

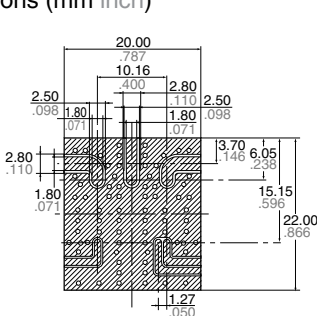

<Surface-mount terminal and Y layout>

PC board

Dimensions (mm inch)

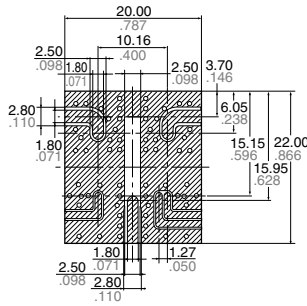

PC board for correction

Dimensions (mm inch)

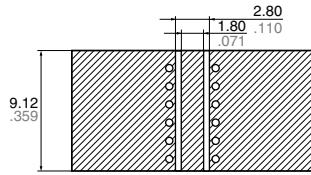

Material: Glass PTFE double-sided through hole PC board R-4737 (Panasonic Electric Works)
Board thickness: $t = 0.8 \text{ mm}$.031 inch
Copper plating: 18 μm
Connector (SMA type receptacle)
Product name: 01K1808-00 (Waka Manufacturing Co., Ltd.)

Insertion loss compensation

The insertion loss of relay itself is given by subtracting the insertion loss of shortcircuit the Com and the NC (or NO). (signal path and two connectors)

2) 75Ω type

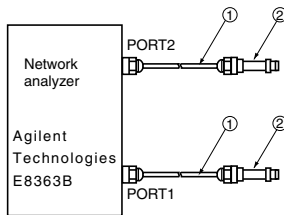

Connect connectors 1 and 2 respectively to PORT 1 and PORT 2. Perform calibration using the 3.5 mm calibration kit (HP85039B).

No.	Product name	Contents
1	85134-60003	Test port cable
2	11852B	Conversion adapter; 50Ω N type (female) to 75Ω N type (male)
2	85039-60011	Conversion adapter; 75Ω N type (female) to 75Ω F type (male)

After calibration, connect the D.U.T. board and measure. However, connectors other than those for measurement should be connected with a 75Ω termination resistor.

<Standard PC board terminal>

PC board

Dimensions (mm inch)

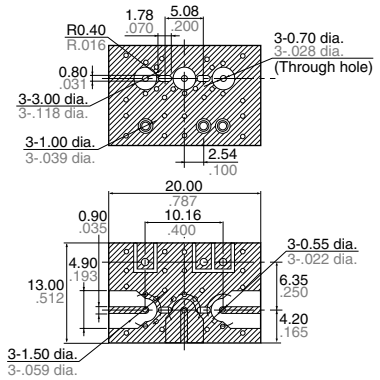

<Surface-mount terminal and E layout>

PC board

Dimensions (mm inch)

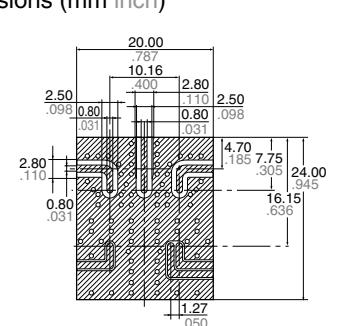

<Surface-mount terminal and Y layout>

PC board

Dimensions (mm inch)

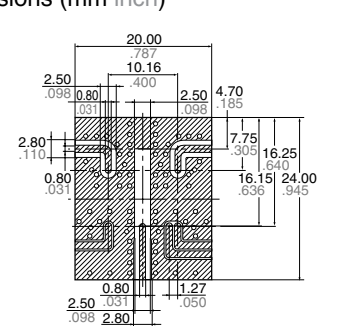

PC board for correction

Dimensions (mm inch)

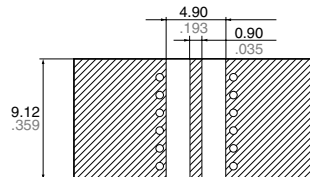

Material: Glass PTFE double-sided through hole PC board R-4737 (Panasonic Electric Works)
Board thickness: $t = 0.8 \text{ mm}$.031 inch
Copper plating: 18 μm
Connector (F type receptacle)
Product name: C05-0236 (Komine Musen Electric Corporation)

Insertion loss compensation

The insertion loss of relay itself is given by subtracting the insertion loss of shortcircuit the COM and the NC (or NO). (signal path and two connectors)

9. Others

1) The switching lifetime is defined under the standard test condition specified in the JIS* C 5442 standard (temperature 15 to 35°C 59 to 95°F, humidity 25 to 75%). Check this with the real device as it is affected by coil driving circuit, load type, activation frequency, activation phase, ambient conditions and other factors.

Also, be especially careful of loads such as those listed below.

- When used for AC load-operating and the operating phase is synchronous, rocking and fusing can easily occur due to contact shifting.
- When high-frequency opening and closing of the relay is performed with a load that causes arcs at the contacts, nitrogen and oxygen in the air is fused by the arc energy and HNO₃ is formed. This can corrode metal materials.

Three countermeasures for these are listed here.

- (1) Incorporate an arc-extinguishing circuit.
 - (2) Lower the operating frequency
 - (3) Lower the ambient humidity
- 2) Use the relay within specifications such as coil rating, contact rating and on/off service life. If used beyond limits, the relay may overheat, generate smoke or catch fire.
- 3) Be careful not to drop the relay. If accidentally dropped, carefully check its appearance and characteristics before use.
- 4) Be careful to wire the relay correctly. Otherwise, malfunction, overheat, fire or other trouble may occur.
- 5) If a relay stays on in a circuit for many months or years at a time without being activated, circuit design should be reviewed so that the relay can remain non-excited. A coil that receives current all the time heats, which degrades insulation earlier than expected. A latching type relay is recommended for such circuits.

6) To ensure accurate operation of the latching type amidst surrounding temperature changes and other factors that might affect the set and reset pulse times, we recommend a coil impress set and reset pulse width of at least 30 ms at the rated operation voltage.

7) The latching type relay is shipped in the reset position. But jolts during transport or impacts during installation can change the reset position. It is, therefore, advisable to build a circuit in which the relay can be initialized (set and reset) just after turning on the power.

8) If silicone materials (e.g., silicone rubbers, silicone oils, silicone coating agents, silicone sealers) are used in the vicinity of the relay, the gas emitted from the silicone may adhere to the contacts of the relay during opening and closing and lead to improper contact. If this is the case, use a material other than silicone.

For general cautions for use, please refer to the “General Application Guidelines”.