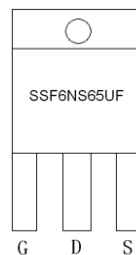
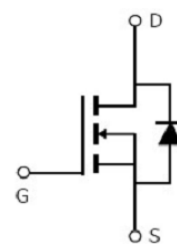

Main Product Characteristics:

V_{DSS}	650V
$R_{DS(on)}$	0.78 Ω (typ.)
I_D	6A ①

TO-220F

Marking and pin Assignment

Schematic diagram
Features and Benefits:

- High dv/dt and avalanche capabilities
- 100% avalanche tested
- Low input capacitance and gate charge
- Low gate input resistance

Description:

The SSF6NS65UF series MOSFETs is a new technology, which combines an innovative technology and advance process. This new technology achieves low $R_{DS(on)}$, energy saving, high reliability and uniformity, superior power density and space saving.

Absolute max Rating:

Symbol	Parameter	Max.	Units
I_D @ TC = 25°C	Continuous Drain Current, V_{GS} @ 10V	6 ①	A
I_D @ TC = 100°C	Continuous Drain Current, V_{GS} @ 10V	3.7①	
I_{DM}	Pulsed Drain Current ②	18	
P_D @TC = 25°C	Power Dissipation ③	29	W
	Linear Derating Factor	0.23	W/°C
V_{DS}	Drain-Source Voltage	650	V
V_{GS}	Gate-to-Source Voltage	± 30	V
E_{AS}	Single Pulse Avalanche Energy @ L=22.5mH	49.6	mJ
I_{AS}	Avalanche Current @ L=22.5mH	2.1	A
T_J T_{STG}	Operating Junction and Storage Temperature Range	-55 to +150	°C

Thermal Resistance

Symbol	Characterizes	Typ.	Max.	Units
$R_{\theta JC}$	Junction-to-case ③	—	4.3	$^{\circ}C/W$
$R_{\theta JA}$	Junction-to-ambient ($t \leq 10s$) ④	—	80	$^{\circ}C/W$

Electrical Characterizes @ $T_A=25^{\circ}C$ unless otherwise specified

Symbol	Parameter	Min.	Typ.	Max.	Units	Conditions
$V_{(BR)DSS}$	Drain-to-Source breakdown voltage	650	—	—	V	$V_{GS} = 0V, I_D = 250\mu A$
$R_{DS(on)}$	Static Drain-to-Source on-resistance	—	0.78	0.9	Ω	$V_{GS}=10V, I_D = 1A$ $T_J = 125^{\circ}C$
		—	1.7	—		
		—	0.84	1.0	Ω	$V_{GS}=10V, I_D = 2.8A$ $T_J = 125^{\circ}C$
		—	1.98	—		
$V_{GS(th)}$	Gate threshold voltage	2	—	4	V	$V_{DS} = V_{GS}, I_D = 250\mu A$ $T_J = 125^{\circ}C$
		—	2.4	—		
I_{DSS}	Drain-to-Source leakage current	—	—	1	μA	$V_{DS} = 650V, V_{GS} = 0V$ $T_J = 125^{\circ}C$
		—	—	50		
I_{GSS}	Gate-to-Source forward leakage	—	—	100	nA	$V_{GS} = 30V$ $V_{GS} = -30V$
		—	—	-100		
Q_g	Total gate charge	—	12	—	nC	$I_D = 1.5A,$ $V_{DS}=480V,$ $V_{GS} = 10V$
Q_{gs}	Gate-to-Source charge	—	2.3	—		
Q_{gd}	Gate-to-Drain("Miller") charge	—	2.5	—		
$t_{d(on)}$	Turn-on delay time	—	8.9	—	ns	$V_{GS}=10V, V_{DS} = 400V,$ $R_{GEN}=10.2\Omega, I_D = 1.5A$
t_r	Rise time	—	5.1	—		
$t_{d(off)}$	Turn-Off delay time	—	25	—		
t_f	Fall time	—	13	—		
C_{iss}	Input capacitance	—	342	—	pF	$V_{GS} = 0V$ $V_{DS} = 100V$ $f = 1MHz$
C_{oss}	Output capacitance	—	19	—		
C_{rss}	Reverse transfer capacitance	—	3.0	—		

Source-Drain Ratings and Characteristics

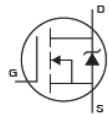
Symbol	Parameter	Min.	Typ.	Max.	Units	Conditions
I_S	Continuous Source Current (Body Diode)	—	—	6 ①	A	MOSFET symbol showing the integral reverse p-n junction diode. 
I_{SM}	Pulsed Source Current (Body Diode)	—	—	18	A	
V_{SD}	Diode Forward Voltage	—	0.83	1.2	V	$I_S=2.8A, V_{GS}=0V$
t_{rr}	Reverse Recovery Time	—	102	—	nS	$T_J = 25^{\circ}C, I_F = 1.5A,$
Q_{rr}	Reverse Recovery Charge	—	476	—	nC	$di/dt = 100A/\mu s$

Test circuits and Waveforms

EAS Test Circuit:

Gate charge test circuit:

Switching Time Test Circuit:

Switching Waveforms:

Notes:

- ① Calculated continuous current based on maximum allowable junction temperature.
- ② Repetitive rating; pulse width limited by max. junction temperature.
- ③ The power dissipation PD is based on max. junction temperature, using junction-to-case thermal resistance.
- ④ The value of $R_{\theta JA}$ is measured with the device mounted on 1 in 2 FR-4 board with 2oz. Copper, in a still air environment with $T_A = 25^\circ\text{C}$

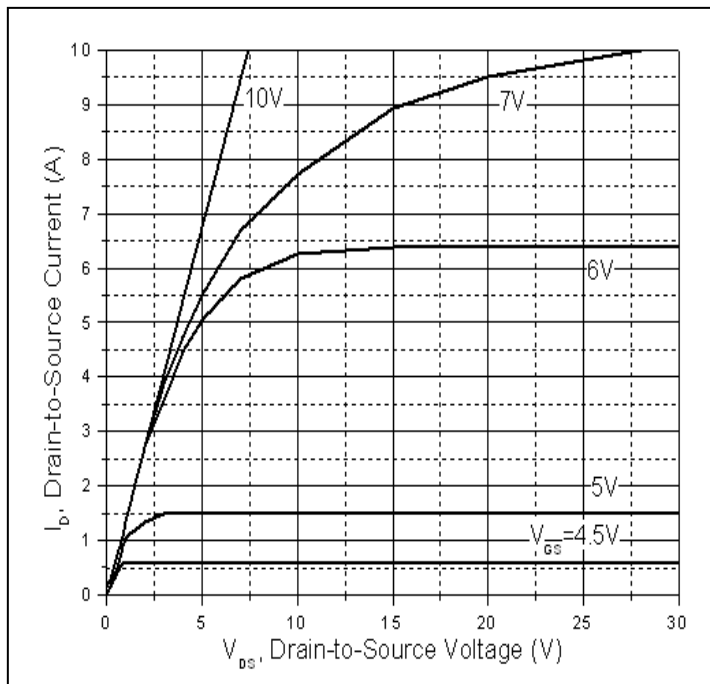
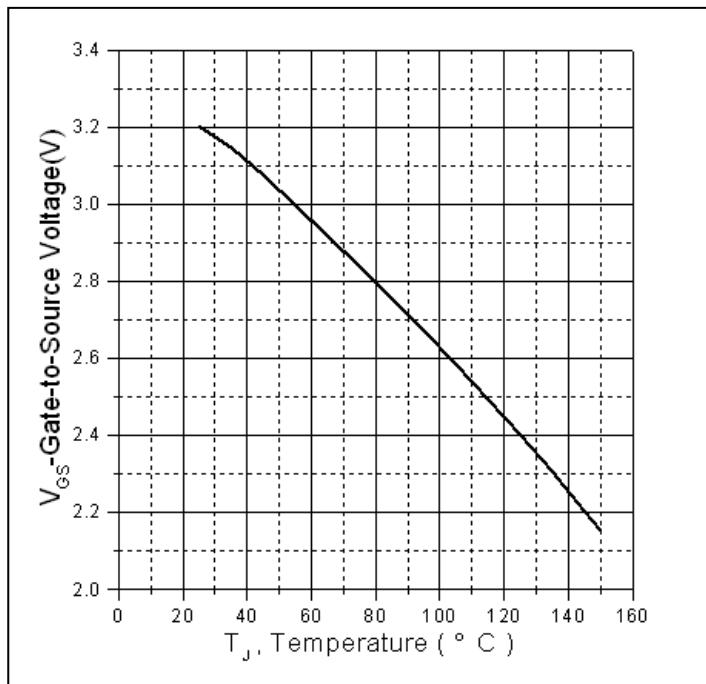
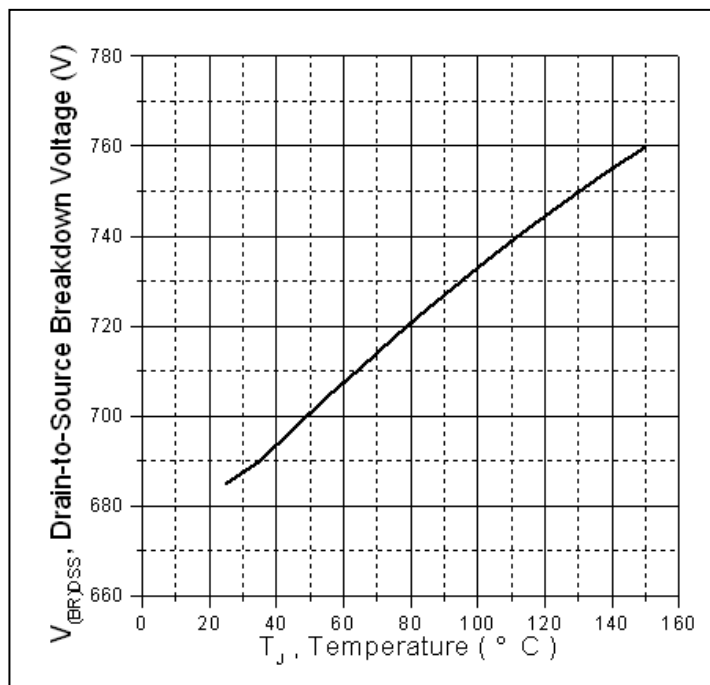
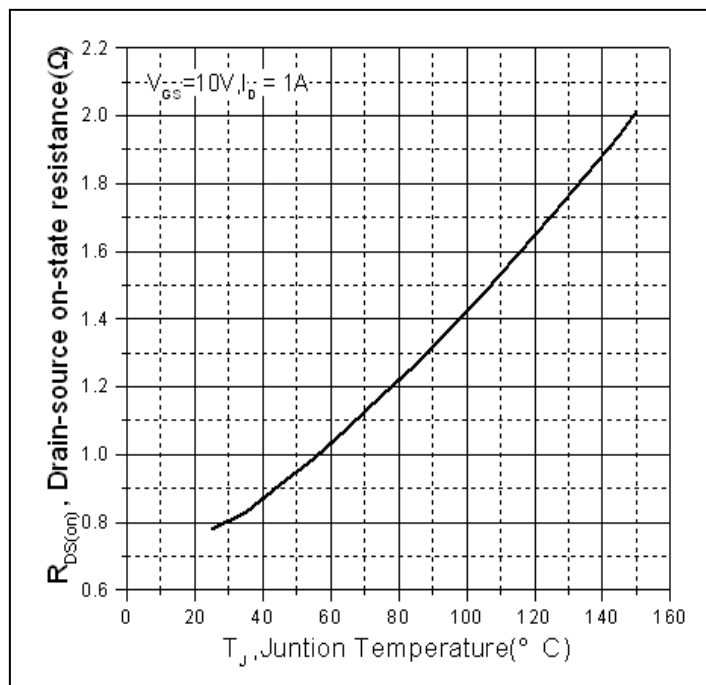
Typical electrical and thermal characteristics

Figure 1: Typical Output Characteristics

Figure 2. Gate to source cut-off voltage

Figure 3. Drain-to-Source Breakdown Voltage Vs. Case Temperature

Figure 4: Normalized On-Resistance Vs. Case Temperature

Typical electrical and thermal characteristics

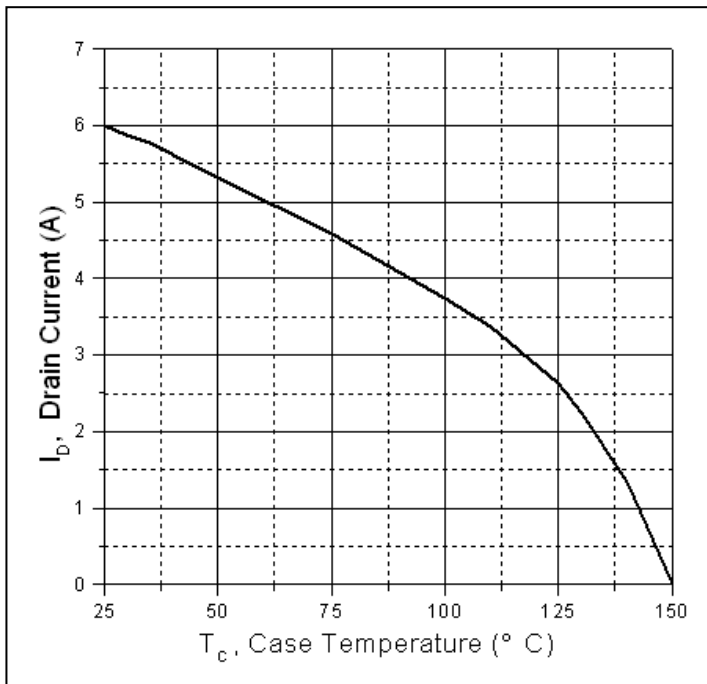

Figure 5. Maximum Drain Current Vs. Case Temperature

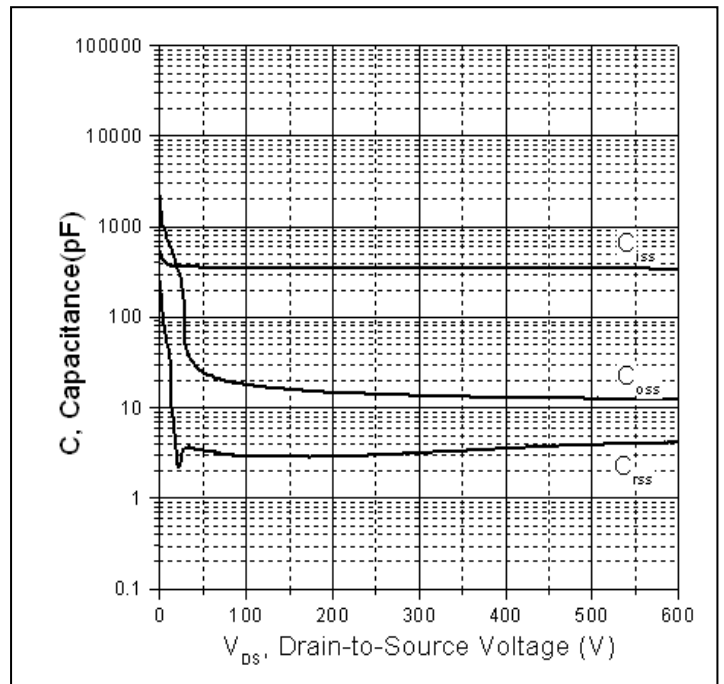

Figure 6. Typical Capacitance Vs. Drain-to-Source Voltage

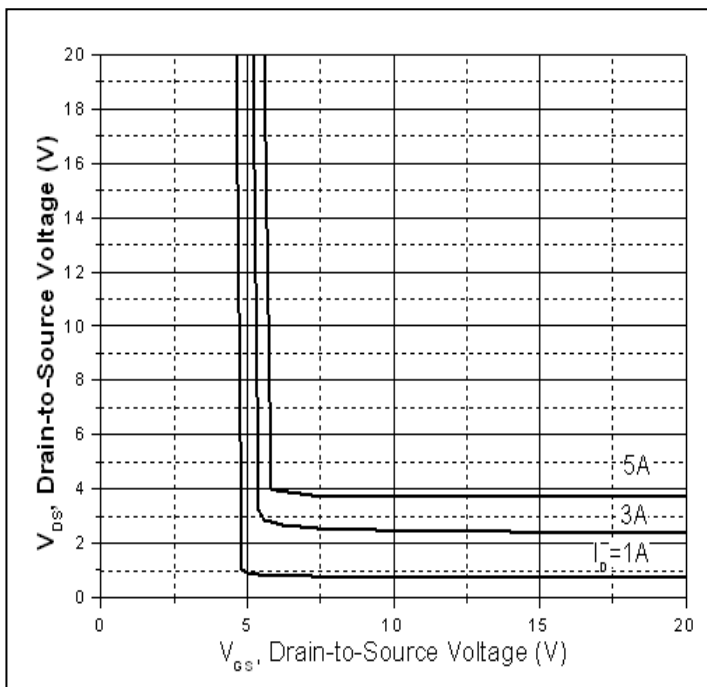

Figure 7. Drain-to-Source Voltage Vs. Gate-to-Source Voltage

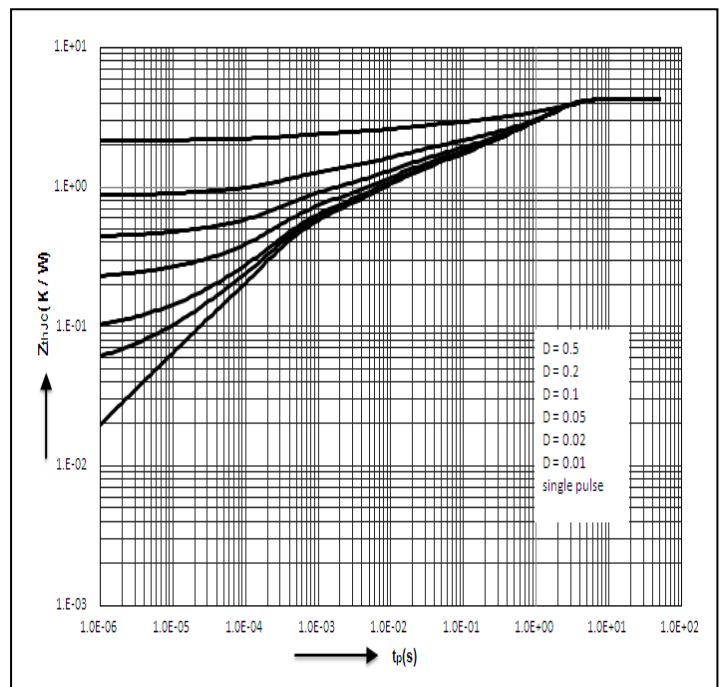
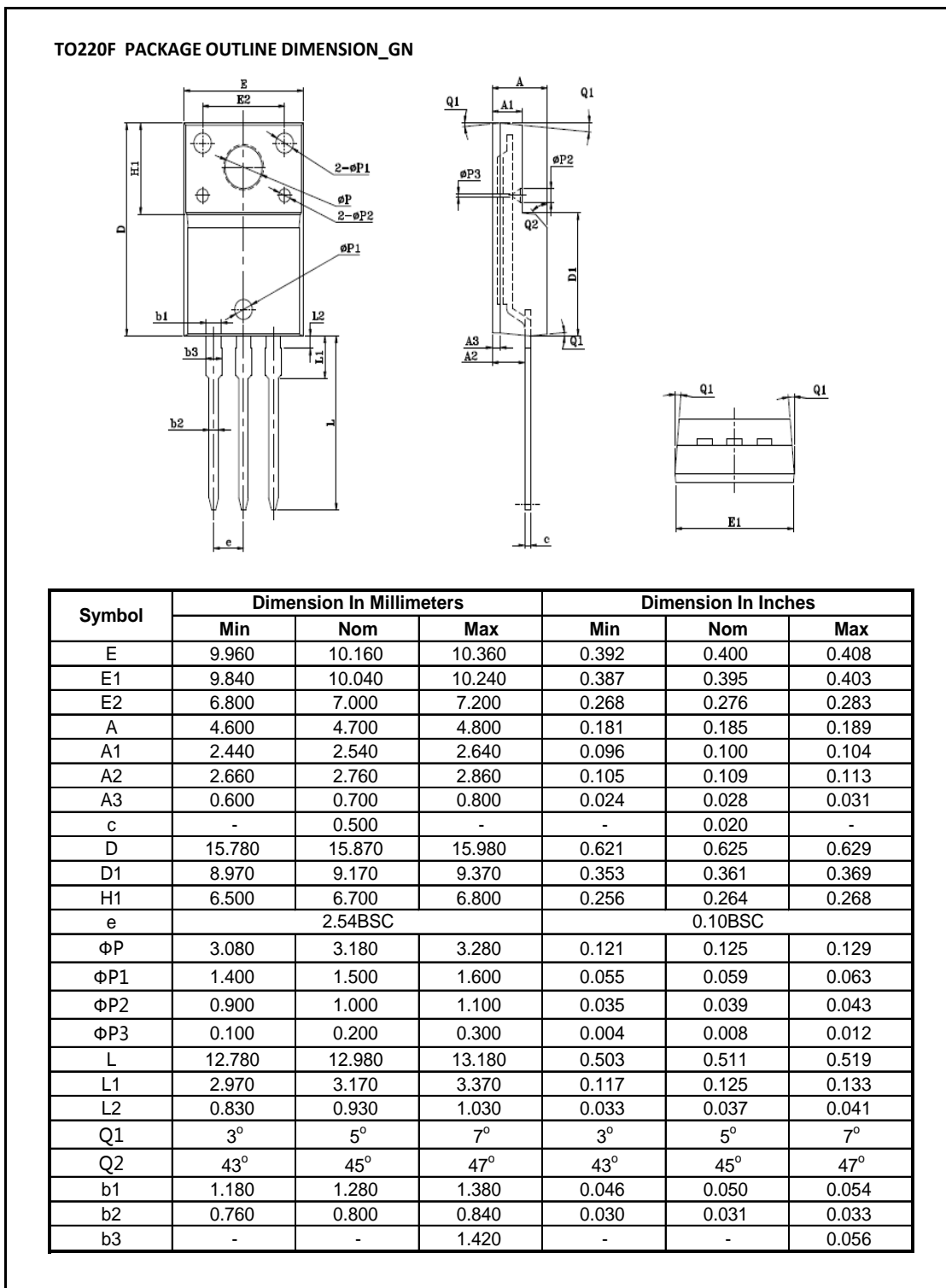

Figure 8. Maximum Effective Transient Thermal Impedance, Junction-to-Case

Mechanical Data:

Ordering and Marking Information
Device Marking: SSF6NS65UF

Package (Available)
TO-220F
Operating Temperature Range
C : -55 to 150 °C

Devices per Unit

Package Type	Units/Tube	Tubes/Inner Box	Units/Inner Box	Inner Boxes/Carton Box	Units/Carton Box
TO-220F	50	20	1000	6	6000

Reliability Test Program

Test Item	Conditions	Duration	Sample Size
High Temperature Reverse Bias(HTRB)	$T_j=125^{\circ}\text{C}$ to 150°C @ 80% of Max $V_{DSS}/V_{CES}/V_R$	168 hours 500 hours 1000 hours	3 lots x 77 devices
High Temperature Gate Bias(HTGB)	$T_j=150^{\circ}\text{C}$ @ 100% of Max V_{GSS}	168 hours 500 hours 1000 hours	3 lots x 77 devices

ATTENTION:

- Any and all Silikron products described or contained herein do not have specifications that can handle applications that require extremely high levels of reliability, such as life-support systems, aircraft's control systems, or other applications whose failure can be reasonably expected to result in serious physical and/or material damage. Consult with your Silikron representative nearest you before using any Silikron products described or contained herein in such applications.
- Silikron assumes no responsibility for equipment failures that result from using products at values that exceed, even momentarily, rated values (such as maximum ratings, operating condition ranges, or other parameters) listed in products specifications of any and all Silikron products described or contained herein.
- Specifications of any and all Silikron products described or contained herein stipulate the performance, characteristics, and functions of the described products in the independent state, and are not guarantees of the performance, characteristics, and functions of the described products as mounted in the customer's products or equipment. To verify symptoms and states that cannot be evaluated in an independent device, the customer should always evaluate and test devices mounted in the customer's products or equipment.
- Silikron Semiconductor CO.,LTD. strives to supply high-quality high-reliability products. However, any and all semiconductor products fail with some probability. It is possible that these probabilistic failures could give rise to accidents or events that could endanger human lives, that could give rise to smoke or fire, or that could cause damage to other property. When designing equipment, adopt safety measures so that these kinds of accidents or events cannot occur. Such measures include but are not limited to protective circuits and error prevention circuits for safe design, redundant design, and structural design.
- In the event that any or all Silikron products(including technical data, services) described or contained herein are controlled under any of applicable local export control laws and regulations, such products must not be exported without obtaining the export license from the authorities concerned in accordance with the above law.
- No part of this publication may be reproduced or transmitted in any form or by any means, electronic or mechanical, including photocopying and recording, or any information storage or retrieval system, or otherwise, without the prior written permission of Silikron Semiconductor CO.,LTD.
- Information (including circuit diagrams and circuit parameters) herein is for example only ; it is not guaranteed for volume production. Silikron believes information herein is accurate and reliable, but no guarantees are made or implied regarding its use or any infringements of intellectual property rights or other rights of third parties.
- Any and all information described or contained herein are subject to change without notice due to product/technology improvement, etc. When designing equipment, refer to the "Delivery Specification" for the Silikron product that you intend to use.

Customer Service**Worldwide Sales and Service:**

Sales@silikron.com

Technical Support:

Technical@silikron.com

Suzhou Silikron Semiconductor Corp.

11A, 428 Xinglong Street, Suzhou Industrial Park, P.R.China

TEL: (86-512) 62560688

FAX: (86-512) 65160705

E-mail: Sales@silikron.com