

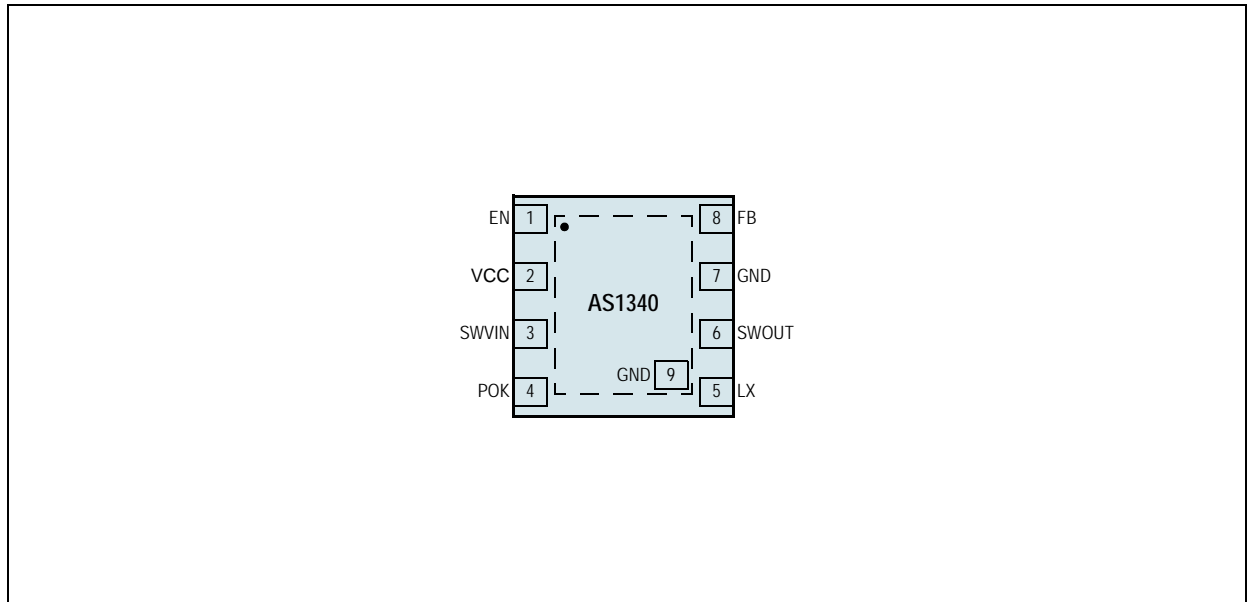



## 4 Pin Assignments

Figure 2. Pin Assignments (Top View)



### 4.1 Pin Descriptions

Table 1. Pin Descriptions

Pin Number	Pin Name	Description
1	EN	<b>Active-High Enable Input.</b> A logic low on this pin shuts down the device and reduces the supply current to 0.1μA. <b>Note:</b> Connect to Vcc for normal operation.
2	VCC	<b>+2.7V to +5.5V Supply Voltage.</b> Bypass this pin to GND with a ≥1μF capacitor.
3	SWVIN	<b>Shutdown Disconnect Switch In</b>
4	POK	<b>Power-OK.</b> 0 = VOUT < 90% of VOUTNOM. 1 = VOUT > 90% of VOUTNOM.
5	LX	<b>Inductor.</b> The drain of the internal N-channel MOSFET. <b>Note:</b> This pin is high impedance in shutdown.
6	SWOUT	<b>Shutdown Disconnect Switch Out.</b> Disconnects the input from the output during shutdown.
7	GND	<b>Ground.</b> This pin and pin 9 must be connected to GND to ensure normal operation.
8	FB	<b>Feedback Pin.</b> Feedback input to the gm error amplifier. Connect a resistor divider tap to this pin. The output voltage can be adjusted from VIN to 50V by: $V_{OUT} = 1.25V[1 + (R1/R2)]$
9	GND	<b>Ground.</b> This pin and pin 7 must be connected to GND to ensure normal operation.



## 5 Absolute Maximum Ratings

Stresses beyond those listed in [Table 2](#) may cause permanent damage to the device. These are stress ratings only, and functional operation of the device at these or any other conditions beyond those indicated in [Electrical Characteristics on page 4](#) is not implied. Exposure to absolute maximum rating conditions for extended periods may affect device reliability.

Table 2. Absolute Maximum Ratings

Parameter	Min	Max	Units	Comments
<b>Electrical Parameters</b>				
VCC, FB, EN to GND	-0.3	7	V	
SWVIN, SWOUT to GND	-0.3	7		
LX to GND		55		
Input Current (latch-up immunity)	-100	100	mA	Norm: JEDEC 78
<b>Electrostatic Discharge</b>				
Electrostatic Discharge HBM	1.5		kV	Norm: MIL 883 E method 3015
<b>Temperature Ranges and Storage Conditions</b>				
Thermal Resistance $\Theta_{JA}$	36.7		°C/W	on PCB
Junction Temperature		+150	°C	
Storage Temperature Range	-55	+125	°C	
Package Body Temperature		+260	°C	The reflow peak soldering temperature (body temperature) specified is in accordance with <i>IPC/JEDEC J-STD-020 "Moisture/Reflow Sensitivity Classification for Non-Hermetic Solid State Surface Mount Devices"</i> . The lead finish for Pb-free leaded packages is matte tin (100% Sn).
Humidity non-condensing	5	85	%	
Moisture Sensitive Level	1			Represents a max. floor life time of unlimited



## 6 Electrical Characteristics

$V_{CC} = EN = 2.7V$ ,  $T_{AMB} = -40$  to  $+85^{\circ}C$  (unless otherwise specified). Typical values are at  $T_{AMB} = +25^{\circ}C$ .

Table 3. Electrical Characteristics

Symbol	Parameter	Condition	Min	Typ	Max	Unit
$T_{AMB}$	Operating Temperature Range		-40		+85	$^{\circ}C$
$V_{CC}$	Supply Voltage		2.7		5.5	V
$V_{IN}$	Inductor Input Voltage Range		2.7		50	V
$V_{OUT}$	Output Voltage Range		2.7		50	V
$I_{CC}$	Quiescent Supply Current	$V_{FB} = 1.3V$ , $V_{IN} = 5V$		30	50	$\mu A$
	Enable Supply Current	$EN = GND$		0.1	1	$\mu A$
$\Delta V_{LNR}$	VCC Line Regulation	$V_{OUT} = 18V$ , $I_{LOAD} = 1mA$ , $V_{IN} = 5.5V$ , $V_{CC} = 2.7$ to $5.5V$		0.3		%/V
	$V_{IN}$ Line Regulation	$V_{OUT} = 18V$ , $I_{LOAD} = 1mA$ , $V_{CC} = 5V$ , $V_{IN} = 2.7$ to $5.5V$		0.25		%/V
$\Delta V_{LDR}$	Load Regulation	$V_{OUT} = 18V$ , $V_{CC} = V_{IN} = 5V$ , $I_{LOAD} = 0$ to $20mA$		0.02		%/mA
$\eta$	Efficiency	$L1 = 10\mu H$ , $V_{IN} = 5.5V$ , $V_{OUT} = 20V$ , $I_{LOAD} =$ $100mA$		88		%
$V_{FB}$	Feedback Set Point		1.225	1.25	1.275	V
$I_{FB}$	Feedback Input Bias Current	$V_{FB} = 1.3V$		5	100	nA
<b>DC-DC Switches</b>						
	$V_{OUT}$ max	$V_{IN} = 5.5V$ , $I_{LOAD} = 0mA$		50		V
$I_{LX(MAX)}$	LX Switch Current Limit	$V_{IN} = 5.5V$ , $I_{LOAD} > 20mA$		1.41		A
$R_{LX}$	LX On-Resistance	$V_{CC} = 5.5V$ , $I_{LX} = 100mA$		0.6		$\Omega$
$R_{P\_ON}$	Switch On-Resistance	$V_{IN} = 5.5V$ , PMOS		0.2		
$I_{LX\_LEAK}$	LX Leakage Current	$V_{LX} = 50V$		2		$\mu A$
$I_{P\_LEAK}$	Switch Leakage Current	$V_{IN} = 5.5V$ , PMOS		0.5		
<b>Control Inputs</b>						
$V_{IH}$	EN Input Threshold	$2.7V \leq V_{CC} \leq 5.5V$	$0.8 \times V_{CC}$			V
$V_{IL}$					$0.2 \times V_{CC}$	
$I_{EN}$	EN Input Bias Current	$V_{CC} = 5.5V$ , $V_{EN} = 0$ to $5.5V$	-1		+1	$\mu A$
<b>POK Output</b>						
$V_{OL}$	POK Output Low Voltage	POK sinking 1mA		0.01	0.2	V
	POK Output High Leakage Current	POK = 5.5V		100	500	nA
	POK Threshold	Rising edge, referenced to $V_{OUT(NOM)}$	87	90	93	%
<b>Oscillator</b>						
$f_{CLK}$	Oscillator Frequency		0.85	1	1.15	MHz
	Maximum Duty Cycle		85	90	95	%

**Note:** All limits are guaranteed. The parameters with min and max values are guaranteed with production tests or SQC (Statistical Quality Control) methods.



## 7 Typical Operating Characteristics

Parts used for measurements: 4.7 $\mu$ H (LPS4018-472ML) Inductor, 10 $\mu$ F (GRM32DR71C106KA01) C<sub>IN</sub> and 1 $\mu$ F (GRM31MR71H105KA88) C<sub>OUT</sub>.

Figure 3. Efficiency vs. Output Current; V<sub>OUT</sub> = 36V

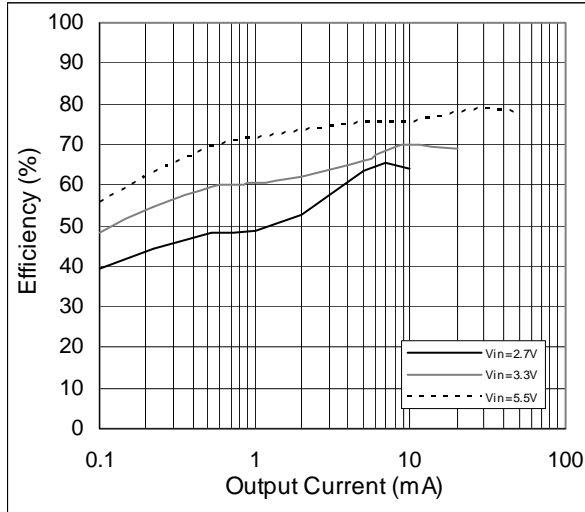

Figure 4. Efficiency vs. Output Current; V<sub>OUT</sub> = 24V

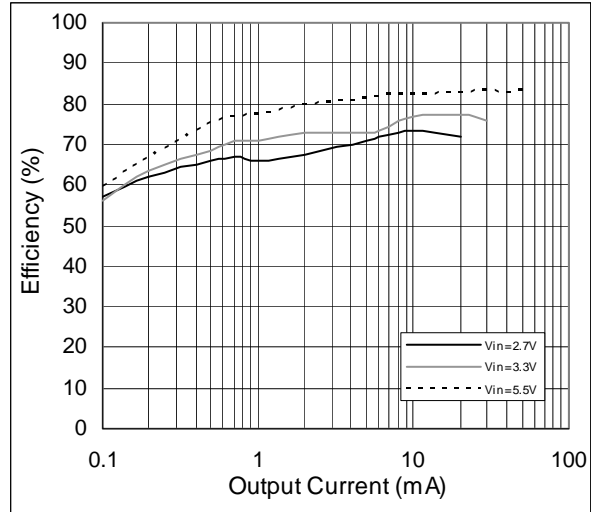

Figure 5. Efficiency vs. Output Current; V<sub>OUT</sub> = 12V

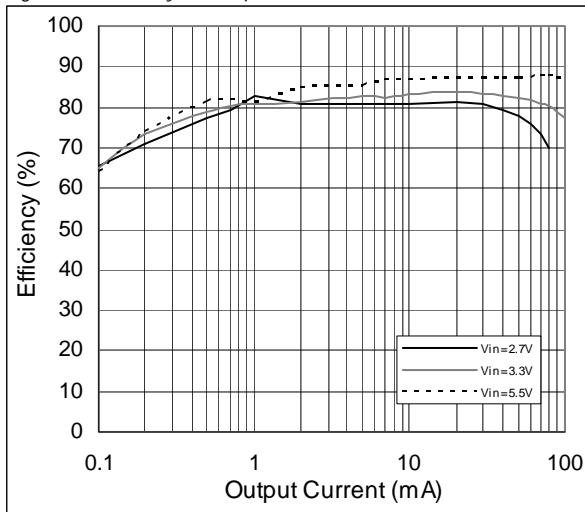

Figure 6. Efficiency vs. Output Current; V<sub>OUT</sub> = 6V

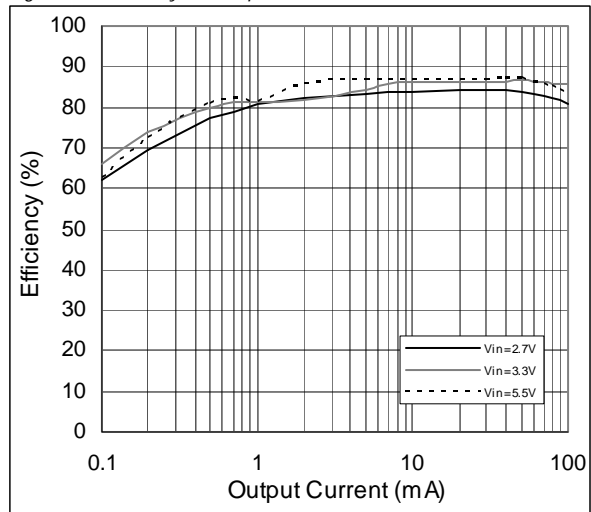

Figure 7. Efficiency vs. V<sub>IN</sub>; V<sub>OUT</sub>=18V, Split Supplies

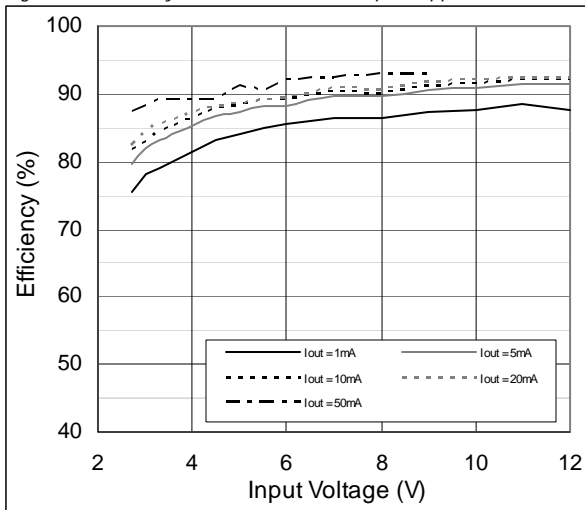

Figure 8. Efficiency vs. V<sub>IN</sub>; I<sub>OUT</sub> = 10mA

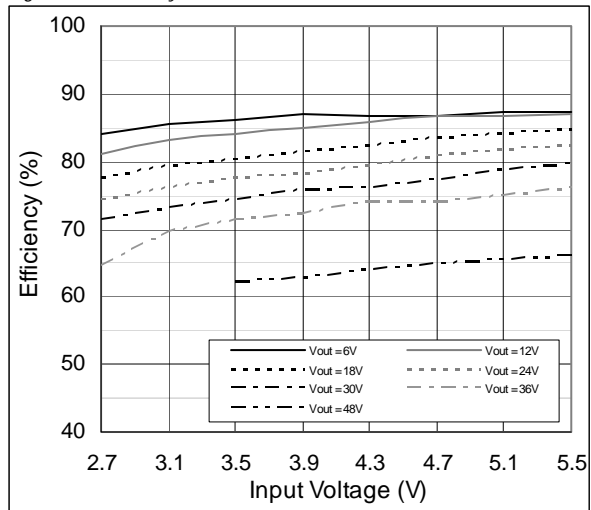



Figure 9. Output Voltage vs. Temperature;  
 $V_{OUT} = 18V$

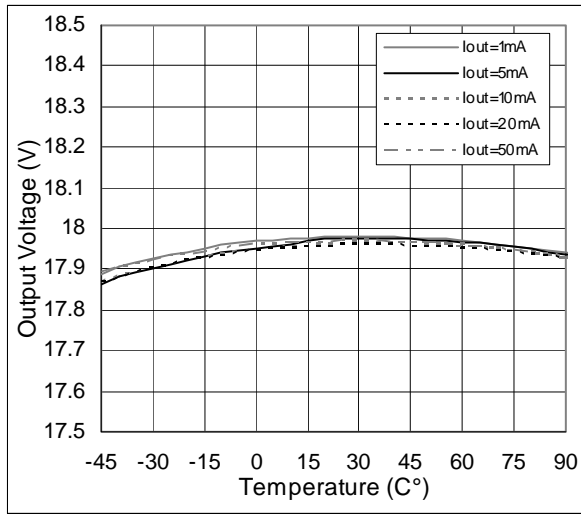

Figure 10. Output Voltage vs. Load Current;  
 $V_{OUT} = 18V, V_{IN} = 3.3V$

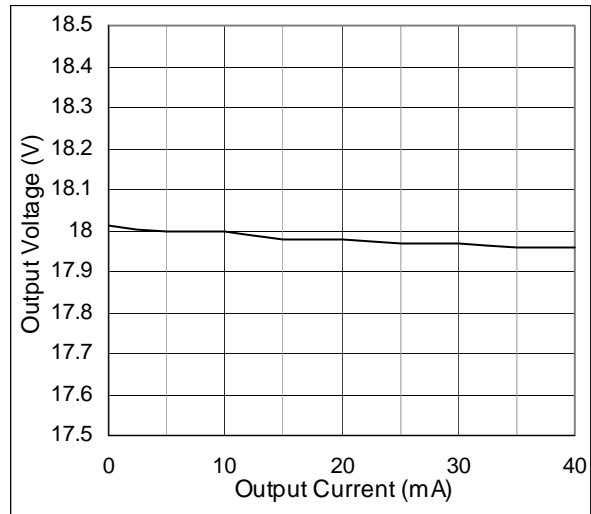

Figure 11. Output Voltage vs. Input Voltage;  
 $V_{OUT} = 18V, \text{Split Supplies}$

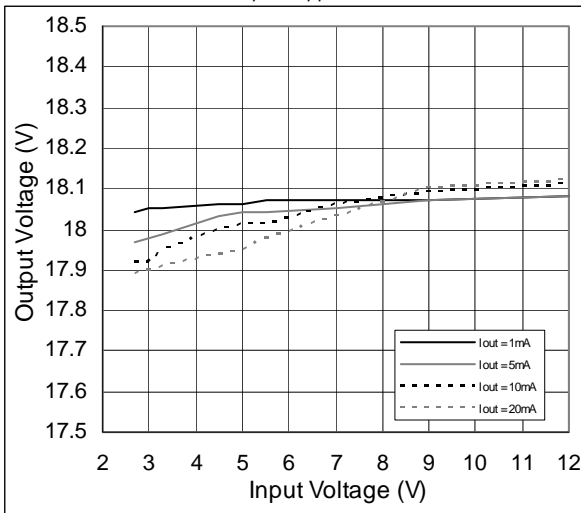

Figure 12. Output Voltage vs. Input Voltage;  
 $V_{OUT} = 18V$

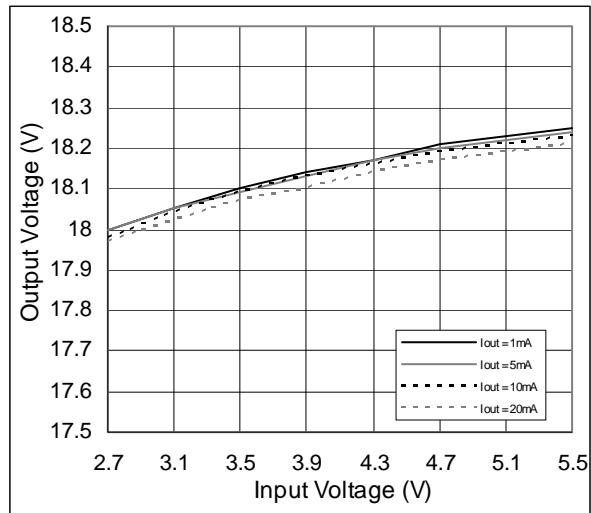

Figure 13. Output Current vs.  $V_{IN}$ ; Split Supplies

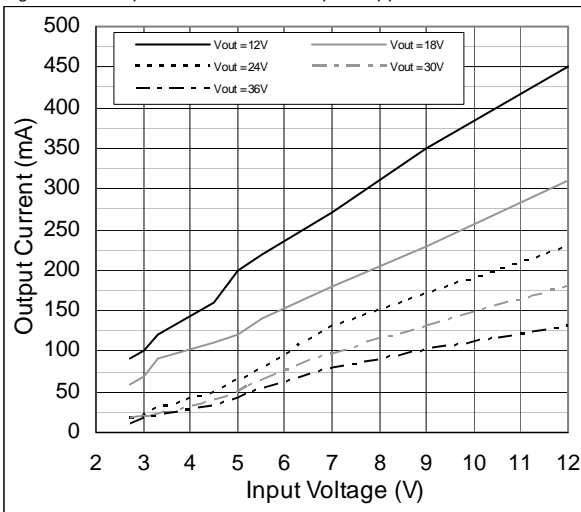

Figure 14. Output Current vs.  $V_{IN}$

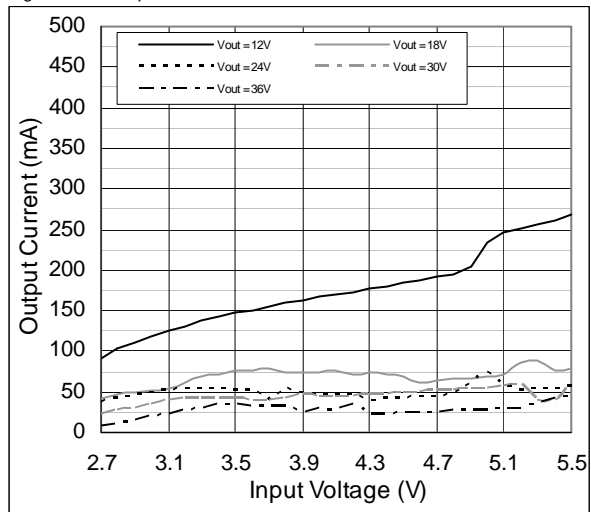



Figure 15. Startup Voltage vs. Output Current;  
VIN = 2.7 to 5.5V

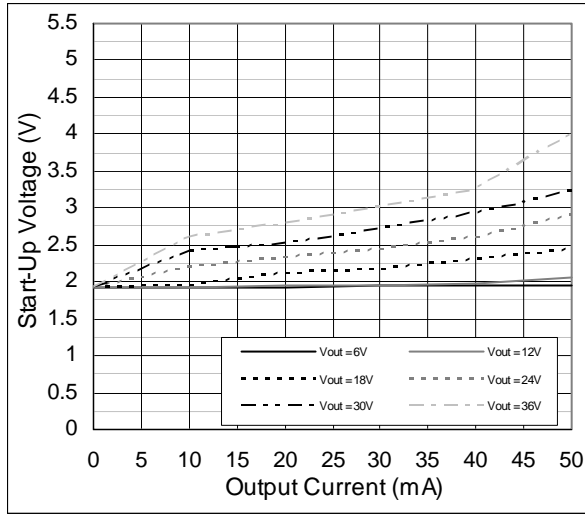

Figure 16. Input Current vs. Input Voltage;  
IOUT = 0mA, switching

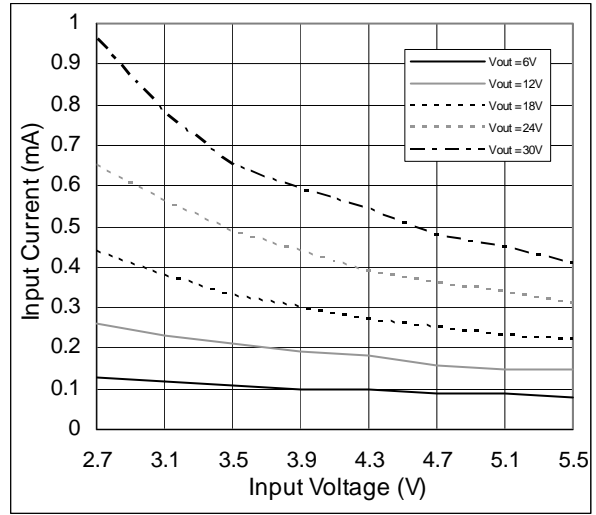

Figure 17. Input Current vs. Output Current;  
VOUT = 12V

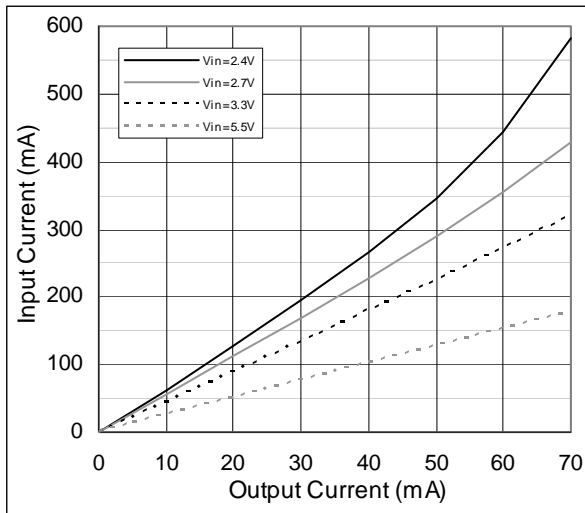

Figure 18. Input Current vs. Output Current;  
VOUT = 18V

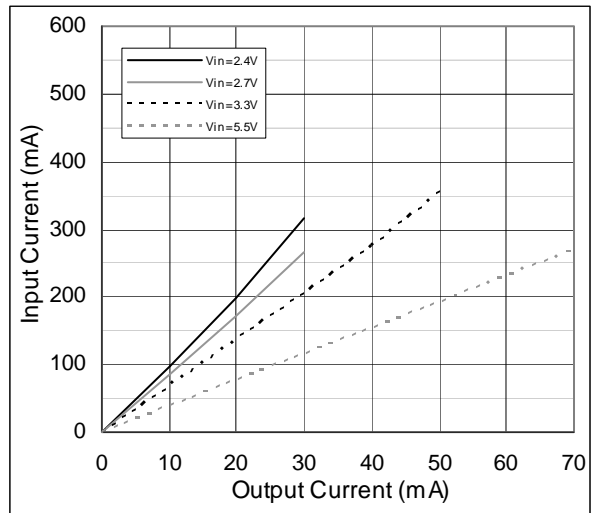

Figure 19. Startup Waveform

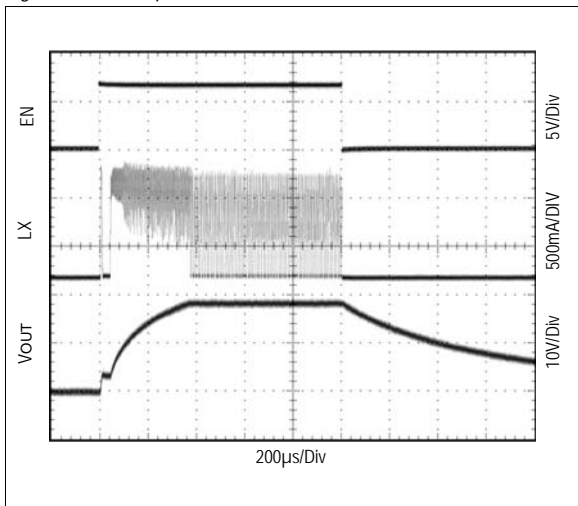

Figure 20. Startup Waveform - POK

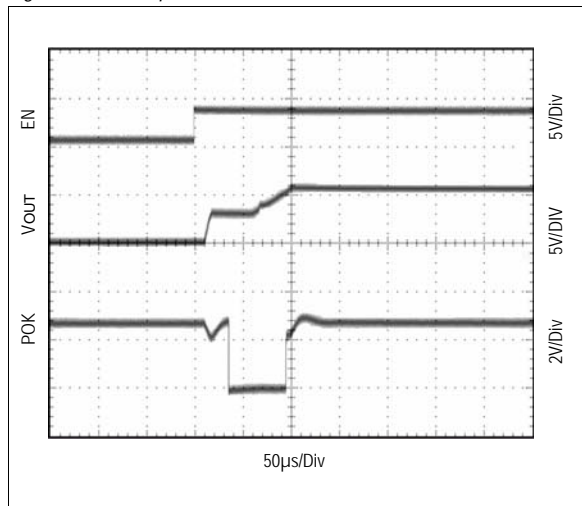



Figure 21. Transient Line Regulation;  
 $V_{OUT} = 18V, I_{LOAD} = 1mA$

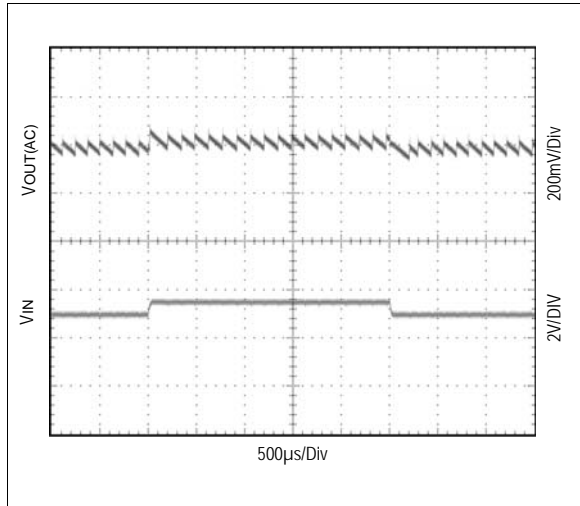

Figure 22. Transient Line Regulation;  
 $V_{OUT} = 18V, I_{LOAD} = 20mA$

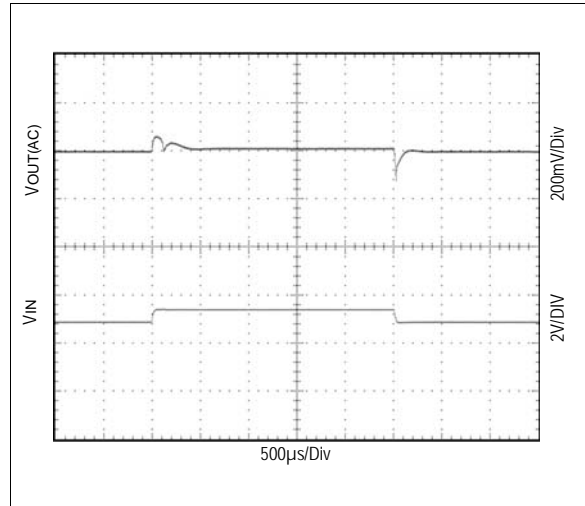

Figure 23. Output Voltage Ripple;  
 $V_{OUT} = 18V, I_{OUT} = 1mA$

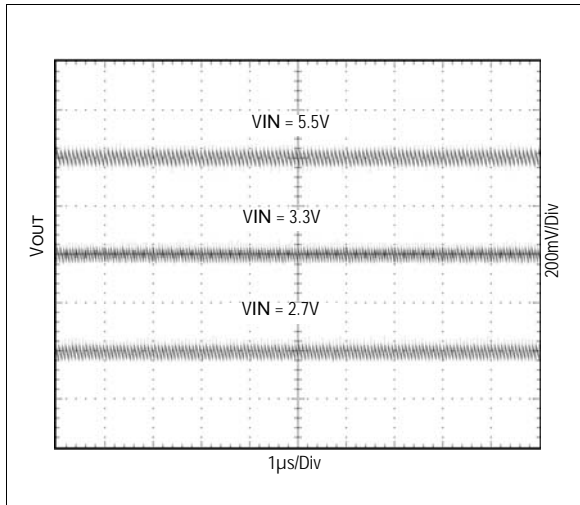

Figure 24. Output Voltage Ripple;  
 $V_{OUT} = 18V, I_{OUT} = 20mA$

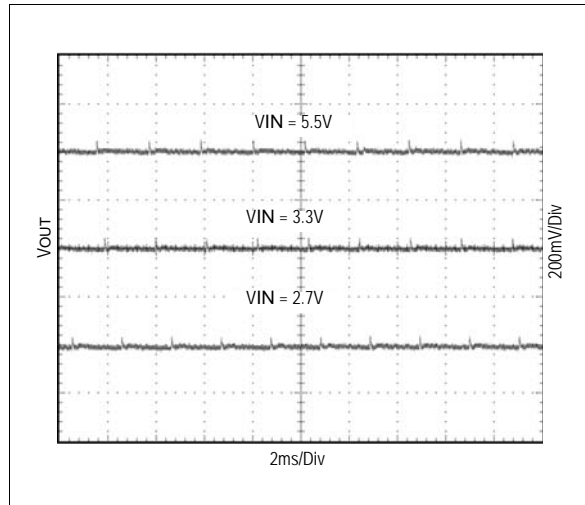

Figure 25. Load Transient Response;  
 $V_{IN} = 5.5V, V_{OUT} = 18V$

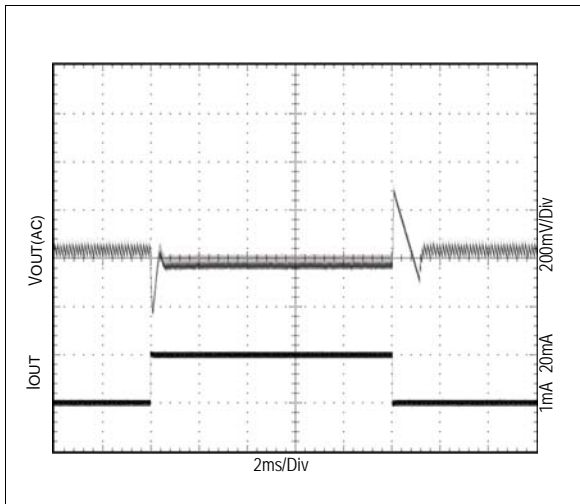
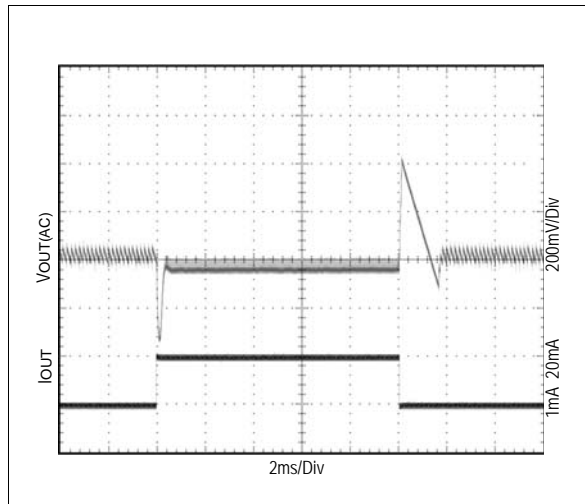

Figure 26. Fixed Frequency vs. Powersave Operation;  
 $V_{IN} = 2.7V, V_{OUT} = 18V$







## 8 Detailed Description

The AS1340 features a current limiting circuitry, a fixed-frequency PWM architecture, power-OK circuitry, thermal protection, and an automatic powersave mode in a tiny package, and maintains high efficiency at light loads.

Figure 27. AS1340 - Block Diagram with Shutdown Disconnect Switch

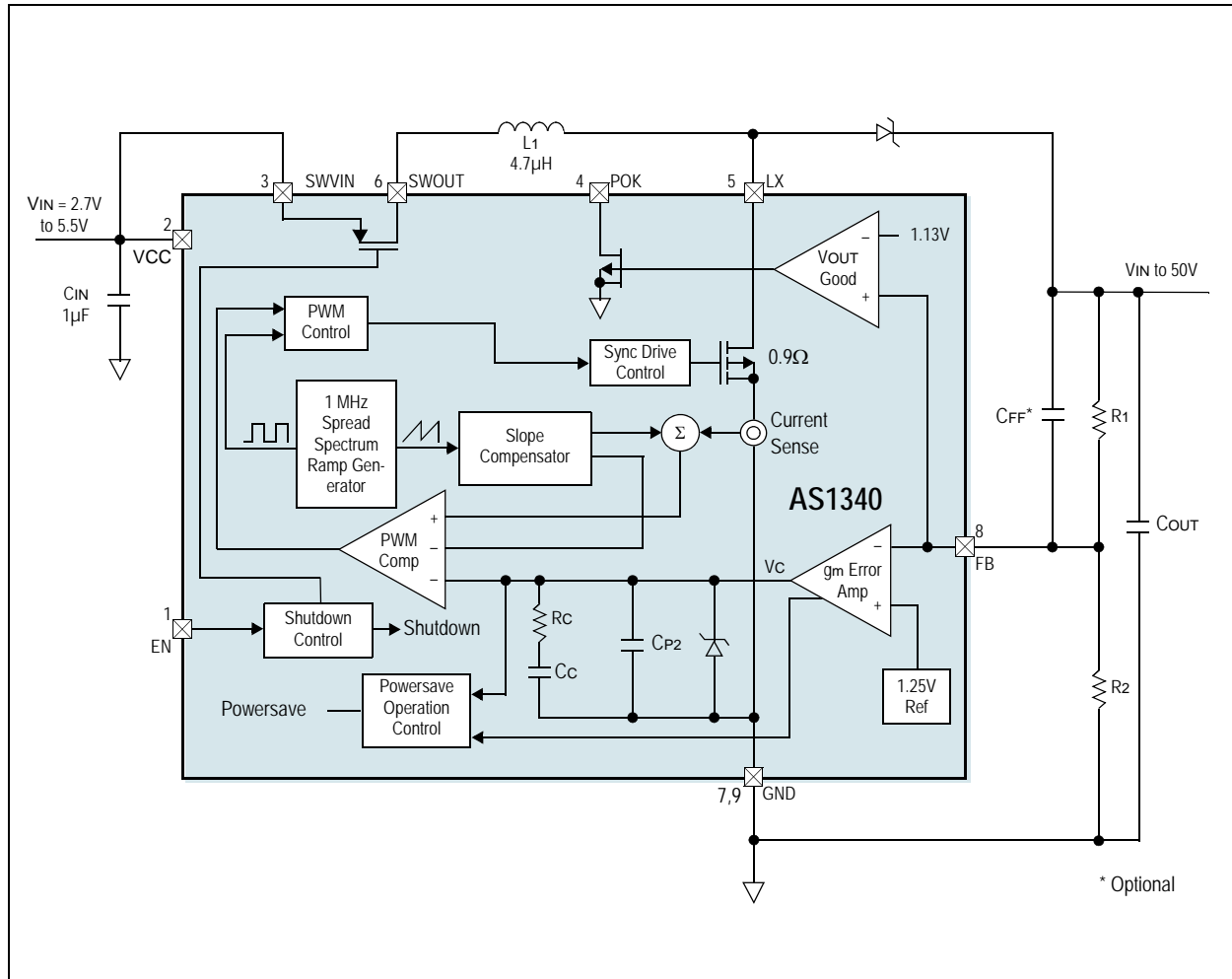

Automatic powersave mode regulates the output and also reduces average current flow into the device, resulting in high efficiency at light loads. When the output increases sufficiently, the powersave comparator output remains high, resulting in continuous operation.

For each oscillator cycle, the power switch is enabled. A voltage proportional to switch current is added to a stabilizing ramp and the resulting sum is delivered to the positive terminal of the PWM comparator.

The error amplifier compares the voltage at FB with the internal 1.25V reference and generates an error signal (VC). When VC is below the powersave mode threshold voltage the automatic powersave-mode is activated and the hysteretic comparator disables the power circuitry, with only the low-power circuitry still active (total current consumption is minimized).

When a load is applied,  $V_{FB}$  decreases; VC increases and enables the power circuitry and the device starts switching. In light loads, the output voltage (and the voltage at FB) will increase until the powersave comparator disables the power circuitry, causing the output voltage to decrease again. This cycle is repeated resulting in low-frequency ripple at the output.

The POK output indicates whether the output voltage is within 90% of the nominal output voltage level or not. When EN is low, the circuit is not active and POK gives a high signal when connected to VCC by a pull-up resistor. When EN goes high, POK goes low after approximately 50µs and will go high when the output reaches 90% of the nominal output voltage (see Figure 20 on page 7). When input and output voltage are almost the same, it may happen that the POK signal does not go low because VOUT reaches 90% before the delay has expired. The open-drain POK output sinks current, when EN is high and the output voltage is below 90% of the nominal output voltage.

Thermal protection circuitry shuts down the device when its temperature reaches 145°C.



## 9 Application Information

### 9.1 Power Supply Concept

The AS1340 has an operating voltage range from 2.7 to 5.5V. If the inductor is supplied from the same source the battery disconnect switch can be used as well (see Figure 1 on page 1). In case that a input voltage source is higher than 5.5V, the inductor can be supplied separately up to 50V (see Figure 28), but then the battery disconnect switch cannot be used, because its operating voltage range is limited to 5.5V.

### 9.2 Shutdown

A logic low on pin EN shuts down the AS1340 and a logic high on EN powers on the device.

In shutdown mode the supply current drops to below 1µA to maximize battery life. In case that the battery disconnect switch is used, the battery is disconnected from the output during shutdown.

**Note:** Pin EN should not be left floating. If the shutdown feature is not used, connect EN to VIN.

### 9.3 Battery Disconnect

The AS1340 has an integrated switch that can be used to disconnect the battery during shutdown. The operation voltage of this switch is limited to 5.5V. When EN is high, the switch is closed and supplies the inductor. Due to the RON resistance the efficiency is slightly lower if the battery disconnect switch is used.

$$P_{LOSS} = I_{IN}^2 \times R_{ON} \quad (EQ 1)$$

### 9.4 Setting Output Voltage

Output voltage can be adjusted by connecting a voltage divider between pins LX and FB (see Figure 28).

Figure 28. Typical Application (SWVIN and SWOUT not in use)

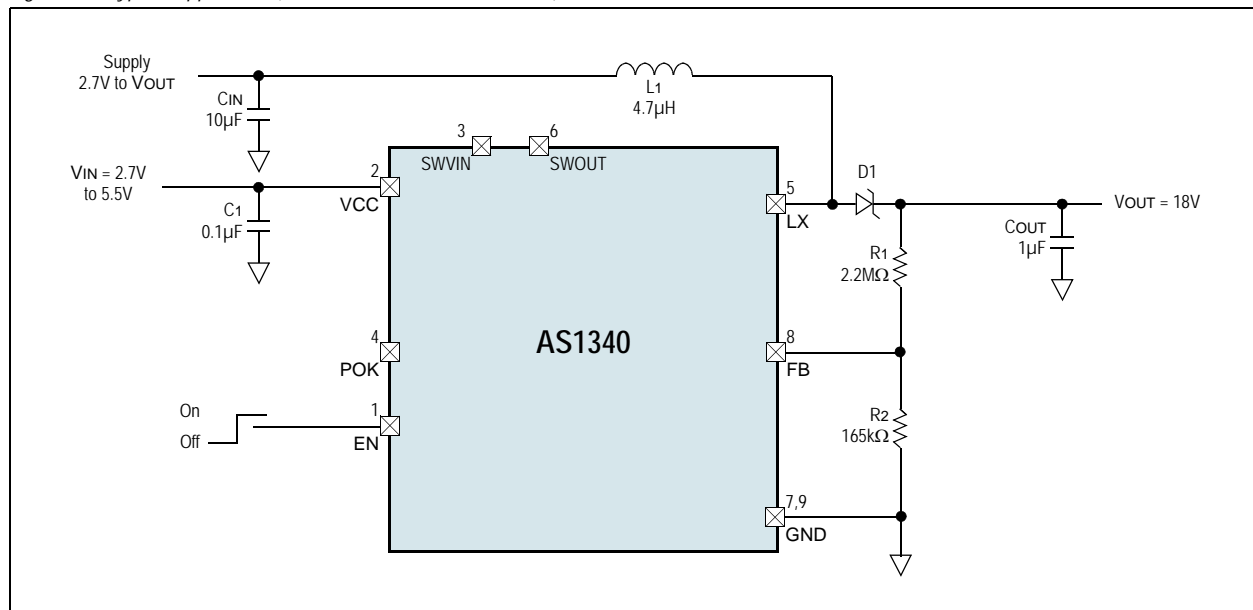

The output voltage can be adjusted by selecting different values for R1 and R2. For R2, select a value between 10k and 200kΩ.

Calculate R1 by:

$$R_1 = R_2 \cdot \left( \frac{V_{OUT}}{V_{FB}} - 1 \right) \quad (EQ 2)$$

#### Where:

$V_{OUT}$  = VIN to 50V,  $V_{FB}$  = 1.25V

The input bias current of FB has a maximum value of 100nA which allows for large-value resistors. For less than 1% error, the current through R2 should be 100 times the feedback input bias current (IFB).



## 9.5 LED Power Supply Application

The AS1340 can also be used for driving LEDs. Just simply connect the LEDs between the pins LX and FB. (see Figure 29).

Figure 29. LED Supply Application

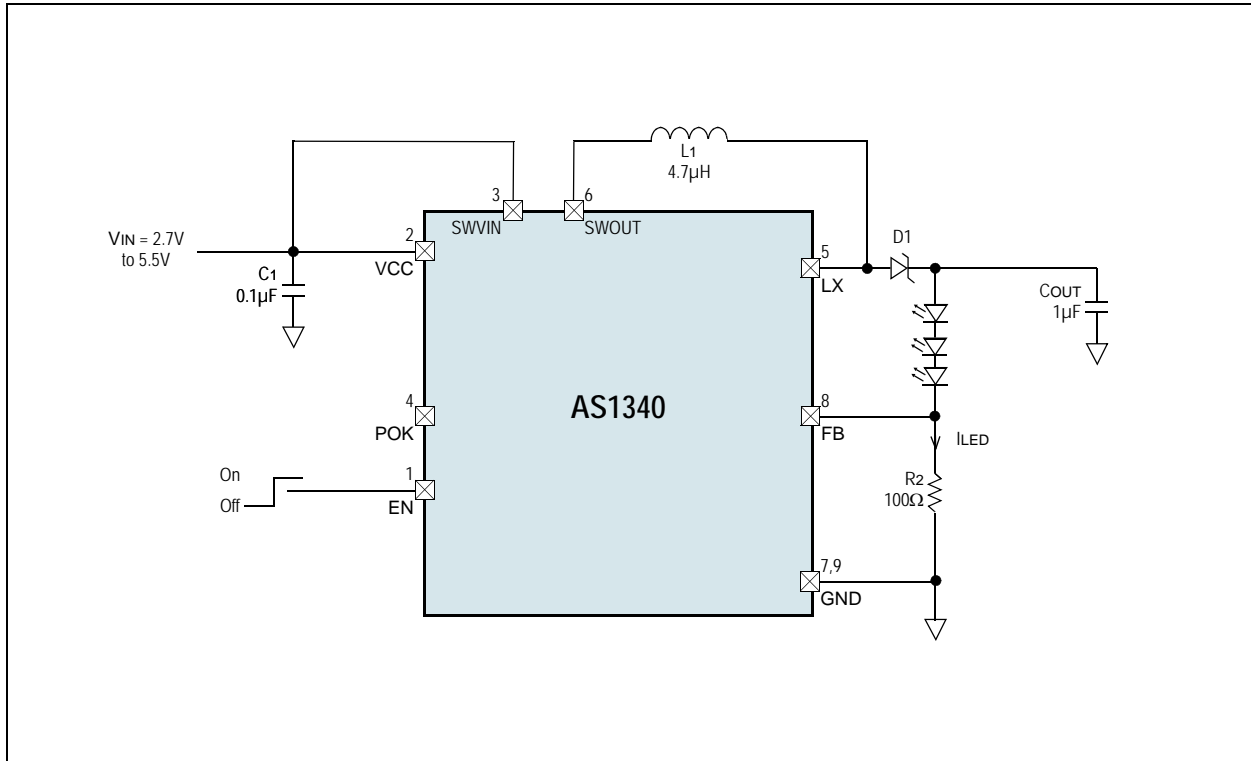

The output voltage is adjusted automatically to the required voltage of the LEDs. This voltage depends on the forward voltage (VF) of the used LEDs and the Feedback Voltage VFB.

Calculate VOUT by:

$$V_{OUT} = V_{F(I_{LED})} \times n + V_{FB} \quad (EQ 3)$$

**Note:** The brightness of the LEDs can directly be adjusted by setting the current ILED via the corresponding R2.

Calculate R2 by:

$$I_{LED} = \frac{V_{FB}}{R_2} \quad (EQ 4)$$

**Where:**

VFB = 1.25V

n .... number of LED's



### 9.6 Inductor Selection

For the external inductor, a 6.8μH inductor is recommended. Minimum inductor size is dependant on the desired efficiency and output current. Inductors with low core losses and small DCR at 1MHz are recommended.

Table 4. Recommended Inductors

Part Number	L	DCR	Current Rating	Dimensions (L/W/T)	Manufacturer
LPS4018-472ML_	4.7μH	0.125Ω	1.9A	4.4x4.4x1.7mm	Coilcraft <a href="http://www.coilcraft.com">www.coilcraft.com</a>
ME3220-472ML_	4.7μH	0.190Ω	1.5A	3.2x2.8x2mm	
MOS6020-472ML_	4.7μH	0.050Ω	1.94A	6.8x6x2.4mm	
MSS6122-472ML_	4.7μH	0.065Ω	1.82A	6.1x6.1x6mm	
LPS4018-682ML_	6.8μH	0.150Ω	1.3A	4.4x4.4x1.7mm	
ME3220-682ML_	6.8μH	0.270Ω	1.2A	3.2x2.8x2mm	
MOS6020-682ML_	6.8μH	0.078Ω	1.72A	6.8x6x2.4mm	
MSS6122-682ML_	6.8μH	0.100Ω	1.50A	6.1x6.1x6mm	

Figure 30. Efficiency Comparison of Different Inductors, VIN = 3.3V, VOUT = 18V

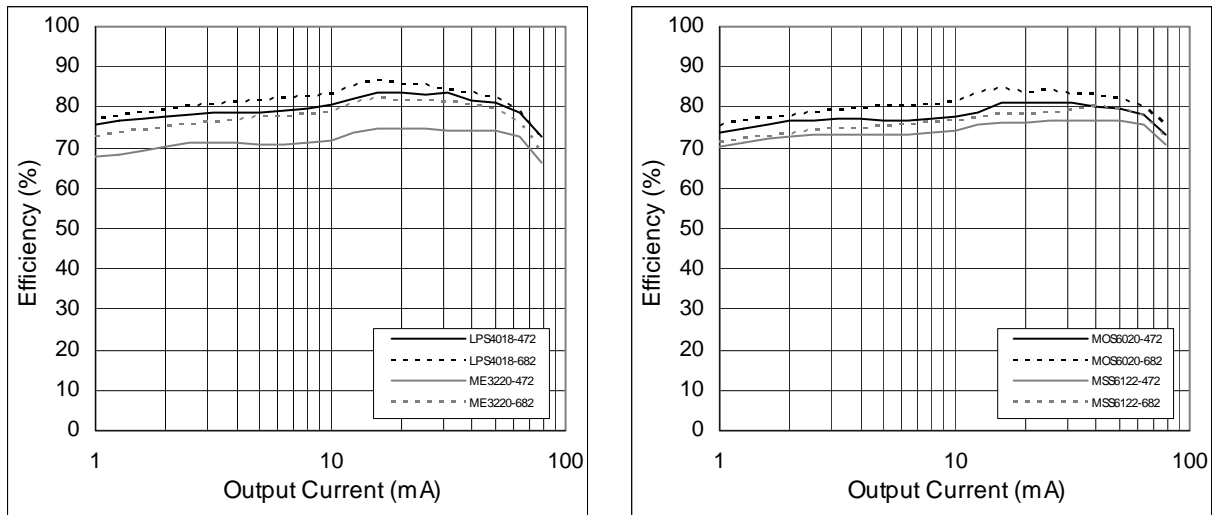
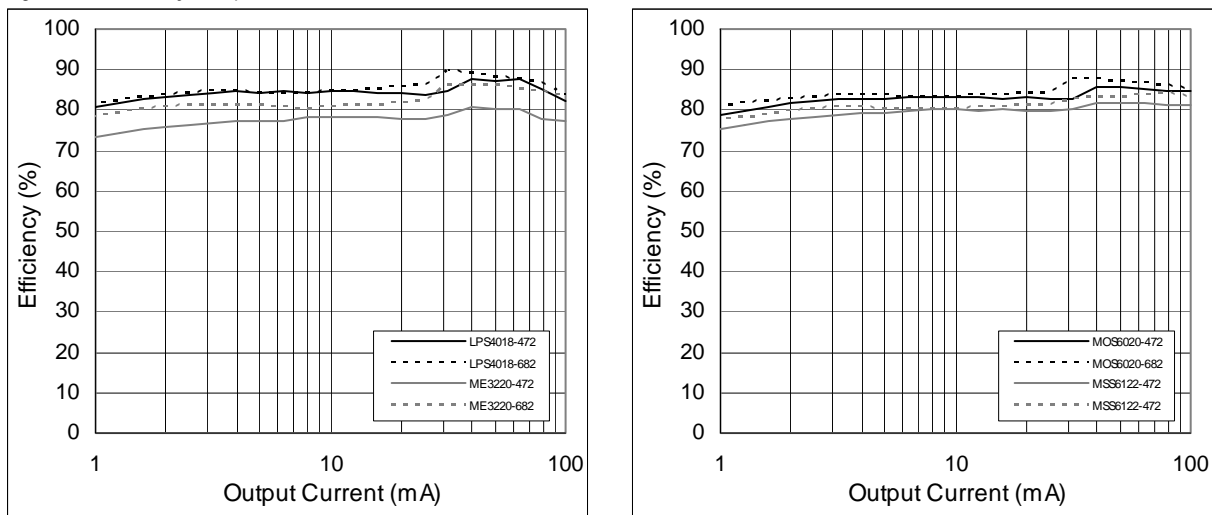

Figure 31. Efficiency Comparison of Different Inductors, VIN = 5.5V, VOUT = 18V





## 9.7 Capacitor Selection

A 4.7 $\mu$ F capacitor is recommended for C<sub>IN</sub> as well as a 2 $\mu$ F for C<sub>OUT</sub>. Small-sized ceramic capacitors are recommended. X5R and X7R ceramic capacitors are recommended as they retain capacitance over wide ranges of voltages and temperatures.

### 9.7.1 Output Capacitor Selection

Low ESR capacitors should be used to minimize V<sub>OUT</sub> ripple. Multi-layer ceramic capacitors are recommended since they have extremely low ESR and are available in small footprints. A 2.2 to 10 $\mu$ F output capacitor is sufficient for most applications. Larger values up to 22 $\mu$ F may be used to obtain extremely low output voltage ripple and improve transient response.

X5R and X7R dielectric materials are recommended due to their ability to maintain capacitance over wide voltage and temperature ranges.

Table 5. Recommended Output Capacitor

Part Number	C	TC Code	Rated Voltage	Dimensions (L/W/T)	Manufacturer
GRM31MR71H105KA88	1 $\mu$ F	X7R	50V	C1206	Murata <a href="http://www.murata.com">www.murata.com</a>
GRM32ER71H475KA88	4.7 $\mu$ F	X7R	50V	C1210	
C1206C105K5RAC	1 $\mu$ F	X7R	50V	C1206	Kemet <a href="http://www.kemet.com">www.kemet.com</a>
C1206C225K5RAC	2.2 $\mu$ F	X7R	50V	C1210	
1206C105KAT2A	1 $\mu$ F	X7R	50V	C1206	AVX <a href="http://www.avx.com">www.avx.com</a>

### 9.7.2 Input Capacitor Selection

Low ESR input capacitors reduce input switching noise and reduce the peak current drawn from the battery. Ceramic capacitors are recommended for input decoupling and should be located as close to the device as is practical. A 4.7 $\mu$ F input capacitor is sufficient for most applications. Larger values may be used without limitations.

Table 6. Recommended Input Capacitor

Part Number	C	TC Code	Rated Voltage	Dimensions (L/W/T)	Manufacturer
GRM21BR71C105KA01	1 $\mu$ F	X7R	16V	C0805	Murata <a href="http://www.murata.com">www.murata.com</a>
GRM21BR61C225KA88	2.2 $\mu$ F	X7R	16V	C0805	
GRM32DR71C106KA01	10 $\mu$ F	X7R	16V	C1210	

### 9.7.3 Diode Selection

A Schottky diode must be used to carry the output current for the time it takes the PMOS synchronous rectifier to switch on.

**Note:** Do not use ordinary rectifier diodes, since the slow recovery times will compromise efficiency.

Table 7. Recommended Diodes

Part Number	Reverse Voltage	Forward Current	Package	Manufacturer
PMEG4010BEA	40V	1A	SOD123	Philips <a href="http://www.nxp.com">www.nxp.com</a>
MBR0540	40V	500mA	SOD123	MCC <a href="http://www.mccsemi.com">www.mccsemi.com</a>
MBR0560	60V	500mA	SOD123	

## 9.8 Thermal Protection

To protect the device from short circuit or excessive power dissipation of the auxiliary NPNs, the integrated thermal protection switches off the device when the junction temperature (T<sub>J</sub>) reaches 145°C (typ). When T<sub>J</sub> decreases to approximately 125°C, the device will resume normal operation. If the thermal overload condition is not corrected, the device will switch on and off while maintaining T<sub>J</sub> within the range between 125°C and 145°C.



## 10 Package Drawings and Markings

Figure 32. TDFN-8 3x3mm Marking

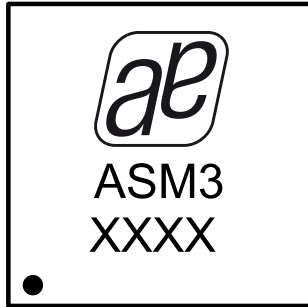

Package Code:  
XXXX - encoded Datecode



Figure 33. TDFN-8 3x3mm Package

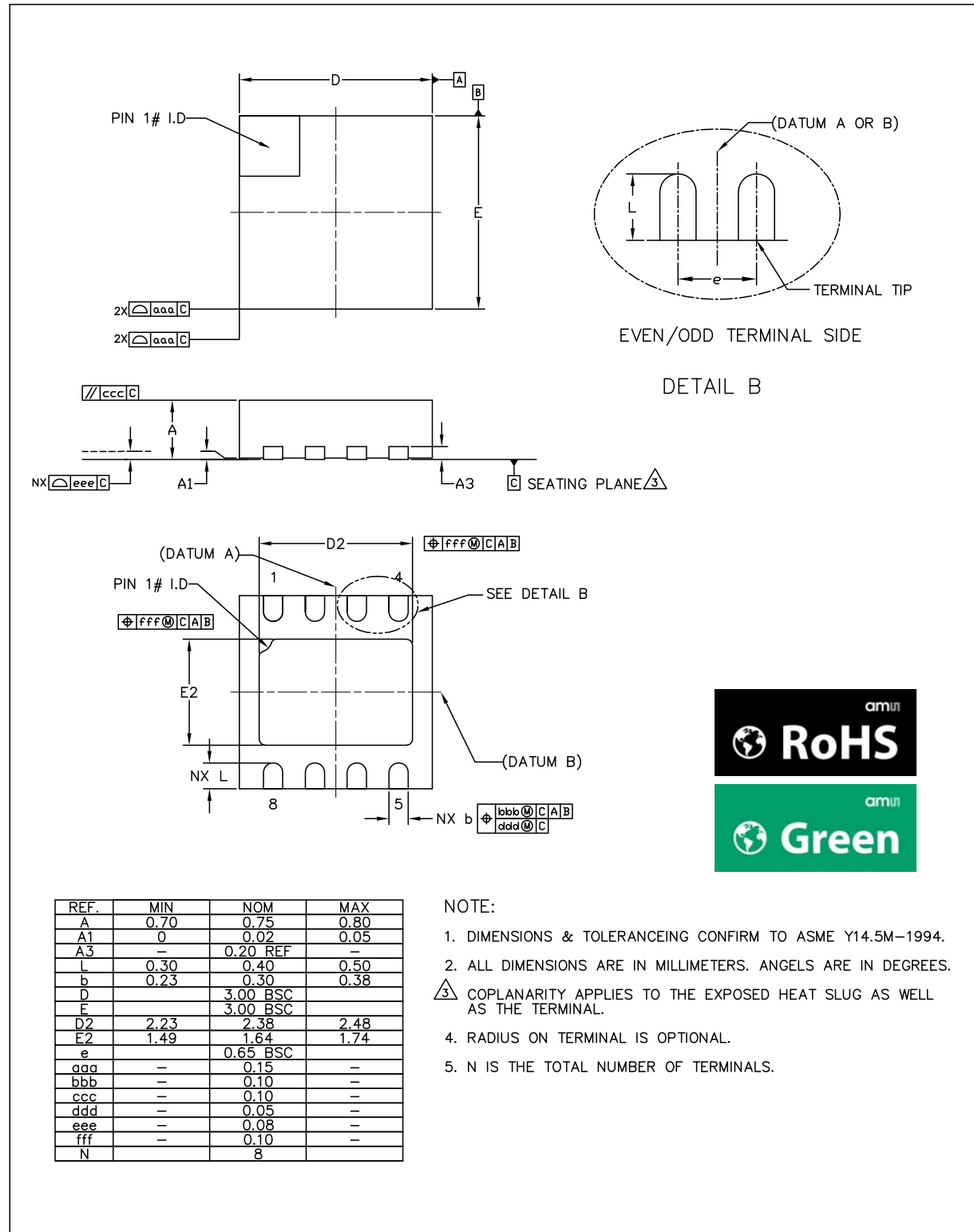

REF.	MIN	NOM	MAX
A	0.70	0.75	0.80
A1	0	0.02	0.05
A3	-	0.20 REF	-
L	0.30	0.40	0.50
b	0.23	0.30	0.38
D	-	3.00 BSC	-
E	-	3.00 BSC	-
D2	2.23	2.38	2.48
E2	1.49	1.64	1.74
e	-	0.65 BSC	-
aaa	-	0.15	-
bbb	-	0.10	-
ccc	-	0.10	-
ddd	-	0.05	-
eee	-	0.08	-
fff	-	0.10	-
N	-	8	-

NOTE:

1. DIMENSIONS & TOLERANCEING CONFIRM TO ASME Y14.5M-1994.
2. ALL DIMENSIONS ARE IN MILLIMETERS. ANGELS ARE IN DEGREES.
3. COPLANARITY APPLIES TO THE EXPOSED HEAT SLUG AS WELL AS THE TERMINAL.
4. RADIUS ON TERMINAL IS OPTIONAL.
5. N IS THE TOTAL NUMBER OF TERMINALS.



			ASSEMBLY ENGINEERING		
			TITLE MLPD 3x3x0.75mm, 8 LEAD, 2.38x1.64mm ePAD		REFERENCE DOCUMENT JEDEC MO-220 LATEST REVISION
DRAWN RH8	DATE 2010.11.16	REV. N/C	DRAWING NO. QBF		UNIT
CHECKED GBO	DATE 2010.11.16	SHEET 1 OF 1	DIMENSION AND TOLERANCE		SCALE NOT IN SCALE
APPROVED MKR	DATE 2010.11.16				



## 11 Ordering Information

The device is available as the standard products shown in [Table 8](#).

*Table 8. Ordering Information*

Ordering Code	Marking	Description	Delivery Form	Package
AS1340A-BTDT-10	ASM3	50V, Micropower, DC-DC Boost Converter, Automatic Power Save, 1MHz	Tape and Reel	TDFN-8 3x3mm

**Note:** All products are RoHS compliant.  
Buy our products or get free samples online at ICdirect: <http://www.ams.com/ICdirect>

Technical Support is found at <http://www.ams.com/Technical-Support>

For further information and requests, please contact us <mailto:sales@ams.com>  
or find your local distributor at <http://www.ams.com/distributor>





## Copyrights

Copyright © 1997-2010, ams AG, Tobelbaderstrasse 30, 8141 Unterpremstaetten, Austria-Europe. Trademarks Registered ®. All rights reserved. The material herein may not be reproduced, adapted, merged, translated, stored, or used without the prior written consent of the copyright owner.

All products and companies mentioned are trademarks or registered trademarks of their respective companies.

## Disclaimer

Devices sold by ams AG are covered by the warranty and patent indemnification provisions appearing in its Term of Sale. ams AG makes no warranty, express, statutory, implied, or by description regarding the information set forth herein or regarding the freedom of the described devices from patent infringement. ams AG reserves the right to change specifications and prices at any time and without notice. Therefore, prior to designing this product into a system, it is necessary to check with ams AG for current information. This product is intended for use in normal commercial applications. Applications requiring extended temperature range, unusual environmental requirements, or high reliability applications, such as military, medical life-support or life-sustaining equipment are specifically not recommended without additional processing by ams AG for each application. For shipments of less than 100 parts the manufacturing flow might show deviations from the standard production flow, such as test flow or test location.

The information furnished here by ams AG is believed to be correct and accurate. However, ams AG shall not be liable to recipient or any third party for any damages, including but not limited to personal injury, property damage, loss of profits, loss of use, interruption of business or indirect, special, incidental or consequential damages, of any kind, in connection with or arising out of the furnishing, performance or use of the technical data herein. No obligation or liability to recipient or any third party shall arise or flow out of ams AG rendering of technical or other services.



## Contact Information

### Headquarters

ams AG  
Tobelbaderstrasse 30  
A-8141 Unterpremstaetten, Austria

Tel: +43 (0) 3136 500 0  
Fax: +43 (0) 3136 525 01

For Sales Offices, Distributors and Representatives, please visit:

<http://www.ams.com/contact>