



Obsolescence Notice

This product is obsolete.

This information is available for your convenience only.

For more information on Zarlink's obsolete products and replacement product lists, please visit http://products.zarlink.com/obsolete_products/

SL1521

300MHz WIDEBAND LOG AMPLIFIER

The SL1521A and C are wideband amplifiers intended for use in successive detection logarithmic IF strips operating at centre frequencies of up to 200MHz. It is a plug in replacement for the SL521 series of RF amplifiers. The midband voltage gain of the SL1521 is typically 12dB. The SL1521A and C differ mainly in the tolerance of voltage gain.

APPLICATIONS

- Radar IF strips
- Wideband Amplification

ABSOLUTE MAXIMUM RATINGS (Non-simultaneous)

Storage temperature range	-55°C to +150°C
Operating temperature range	-55°C to +125°C
Maximum chip operating resistance	150°C
Chip to ambient thermal resistance	250°C/W

Test circuits: see Fig.8

ORDERING INFORMATION

- SL1521 A CM
- SL1521 AB CM
- SL1521 C CM
- SL1521 CB CM

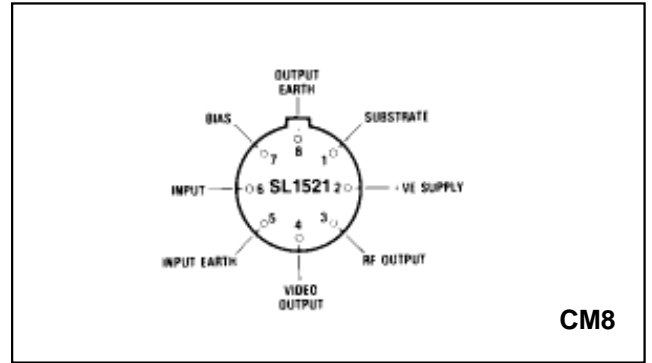

Fig.1 Pin connections

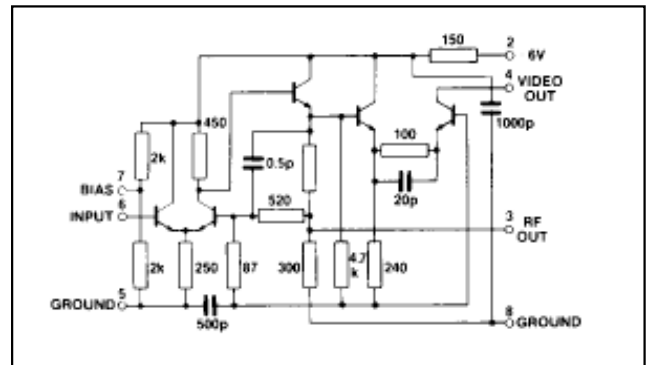

Fig.2 Circuit diagram

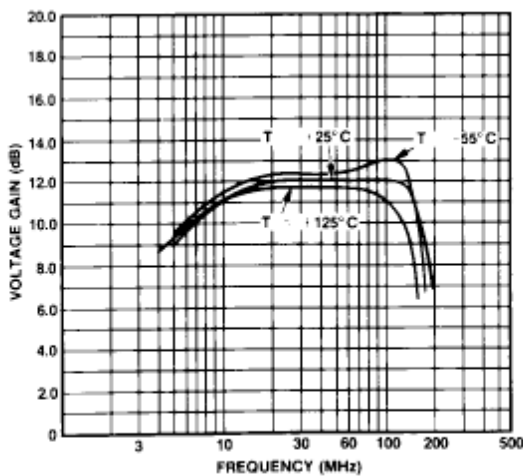

Fig.3 Voltage gain v. frequency

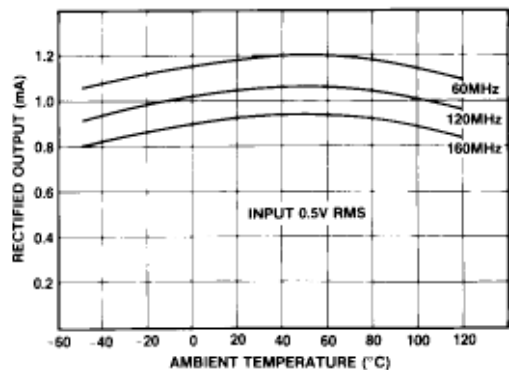

Fig.4 Maximum rectified output current v. temperature

SL1521

ELECTRICAL CHARACTERISTICS

Test conditions (unless otherwise stated):

Temperature = +22°C ± 2°C

Supply voltage = +5.2V

DC connection between input and bias pins

Characteristic	Circuits	Value			Units	Conditions
		Min.	Typ.	Max.		
Voltage gain, f = 120MHz	SL1521A	11.5		12.5	dB	} 3mV rms input 50 ohms source 8pF load + 500Ω
	SL1521AC	10.8		13.1	dB	
Voltage gain, f = 160MHz	SL1521A	11.2		12.8	dB	
	SL1521C	10.6		13.4	dB	
Upper cut-off frequency	SL1521A	250	285		MHz	50 ohms source
	SL1521C		285		MHz	
Lower cut-off frequency	All types		6	10	MHz	50 ohms source
Propagation delay	All types		0.6		ns	
Maximum rectified video output current	SL1521A	0.95		1.05	mA	} f = 120MHz 0.5V rms input 8pF load, 500 ohms in parallel
	SL1521C	0.90		1.20	mA	
Variation of gain with supply voltage	All types		1.0		dB/V	
Variation of maximum rectified output current with supply voltage	All types		30		%V	
Maximum input signal before overload	All types		1.5		V rms	See note below f = 120MHz, source resistance optimised
Noise figure			4.5	6.0	dB	
Supply current	All types	10.0	15.0	20.0	mA	resistance optimised
Maximum RF output voltage	All types	1.0			V p-p	f = 120MHz

OPERATING NOTES

The amplifiers are intended for use directly coupled, as shown in Fig 7

The seventh stage in an untuned cascade will be giving virtually full output on noise.

Noise may be reduced by inserting a single tuned circuit in the chain. As there is a large mismatch between stages a simple shunt or series circuit cannot be used. The choice of network is also controlled by the need to avoid distorting the logarithmic law; the network must give unity voltage transfer at resonance. A suitable network is shown in Fig. 8. The value of C1 must be chosen so that at resonance its admittance equals the total loss conductance across the tuned circuit.

A simple capacitor may not be suitable for decoupling the output line if many stages and fast rise times are required. Values of positive supply line decoupling capacitor required for untuned cascades are given below. Smaller values can be used in high frequency tuned cascades.

The amplifiers have been provided with two earth leads to avoid the introduction of common earth lead inductance between input and output circuits. The equipment designer should take care to avoid the subsequent introduction of such inductance.

	Number of stages			
	6 or more	5	4	3
Minimum capacitance	30nF	10nF	3nF	1nF

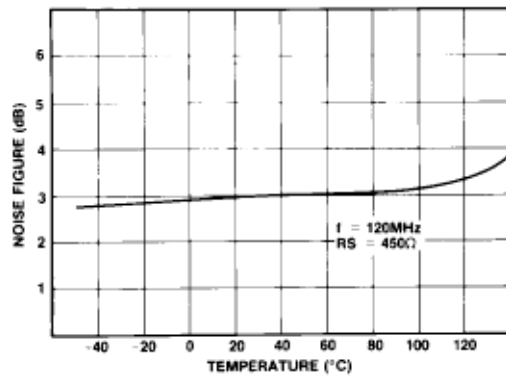

Fig.5 Typical noise figure v. temperature

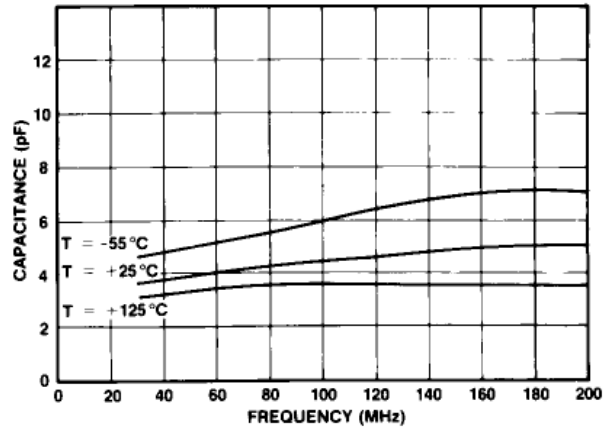

Fig.6 Input admittance with open-circuit output

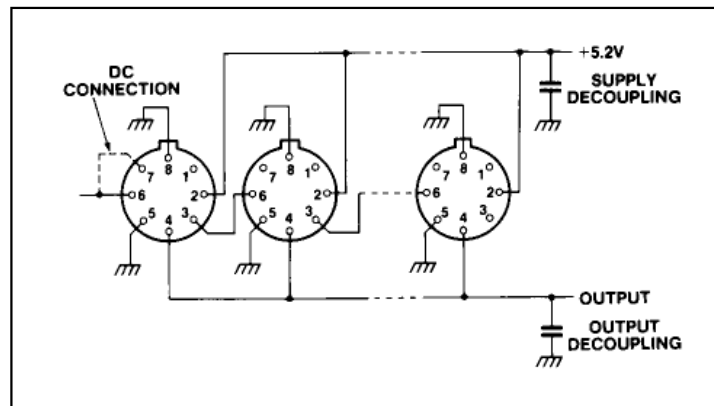

Fig.7 Direct coupled amplifier

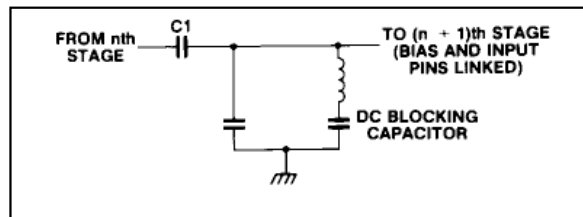

Fig.8 Suitable interstage tuned circuit



**For more information about all Zarlink products
visit our Web Site at
www.zarlink.com**

Information relating to products and services furnished herein by Zarlink Semiconductor Inc. trading as Zarlink Semiconductor or its subsidiaries (collectively "Zarlink") is believed to be reliable. However, Zarlink assumes no liability for errors that may appear in this publication, or for liability otherwise arising from the application or use of any such information, product or service or for any infringement of patents or other intellectual property rights owned by third parties which may result from such application or use. Neither the supply of such information or purchase of product or service conveys any license, either express or implied, under patents or other intellectual property rights owned by Zarlink or licensed from third parties by Zarlink, whatsoever. Purchasers of products are also hereby notified that the use of product in certain ways or in combination with Zarlink, or non-Zarlink furnished goods or services may infringe patents or other intellectual property rights owned by Zarlink.

This publication is issued to provide information only and (unless agreed by Zarlink in writing) may not be used, applied or reproduced for any purpose nor form part of any order or contract nor to be regarded as a representation relating to the products or services concerned. The products, their specifications, services and other information appearing in this publication are subject to change by Zarlink without notice. No warranty or guarantee express or implied is made regarding the capability, performance or suitability of any product or service. Information concerning possible methods of use is provided as a guide only and does not constitute any guarantee that such methods of use will be satisfactory in a specific piece of equipment. It is the user's responsibility to fully determine the performance and suitability of any equipment using such information and to ensure that any publication or data used is up to date and has not been superseded. Manufacturing does not necessarily include testing of all functions or parameters. These products are not suitable for use in any medical products whose failure to perform may result in significant injury or death to the user. All products and materials are sold and services provided subject to Zarlink's conditions of sale which are available on request.

Purchase of Zarlink's I²C components conveys a licence under the Philips I²C Patent rights to use these components in an I²C System, provided that the system conforms to the I²C Standard Specification as defined by Philips.

Zarlink and the Zarlink Semiconductor logo are trademarks of Zarlink Semiconductor Inc.

Copyright 2001, Zarlink Semiconductor Inc. All Rights Reserved.

TECHNICAL DOCUMENTATION - NOT FOR RESALE
