



Advance Information

Low Power Narrowband FM IF

The MC3371 and MC3372 perform single conversion FM reception and consist of an oscillator, mixer, limiting IF amplifier, quadrature discriminator, active filter, squelch switch, and meter drive circuitry. These devices are designed for use in FM dual conversion communication equipment. The MC3371/MC3372 are similar to the MC3361/MC3357 FM IFs, except that a signal strength indicator replaces the scan function controlling driver which is in the MC3361/MC3357. The MC3371 is designed for the use of parallel LC components, while the MC3372 is designed for use with either a 455 kHz ceramic discriminator, or parallel LC components.

These devices also require fewer external parts than earlier products. The MC3371 and MC3372 are available in dual-in-line and surface mount packaging.

- Wide Operating Supply Voltage Range: VCC = 2.0 to 9.0 V
• Input Limiting Voltage Sensitivity of - 3.0 dB
• Low Drain Current: ICC = 3.2 mA, @ VCC = 4.0 V, Squelch Off
• Minimal Drain Current Increase When Squelched
• Signal Strength Indicator: 60 dB Dynamic Range
• Mixer Operating Frequency Up to 100 MHz
• Fewer External Parts Required than Earlier Devices

MAXIMUM RATINGS

Table with 5 columns: Rating, Pin, Symbol, Value, Unit. Rows include Power Supply Voltage, RF Input Voltage, Detector Input Voltage, Squelch Input Voltage, Mute Function, Mute Sink Current, Junction Temperature, and Storage Temperature Range.

Devices should not be operated at these values. The "Recommended Operating Conditions" table provides conditions for actual device operation.

RECOMMENDED OPERATING CONDITIONS

Table with 5 columns: Rating, Pin, Symbol, Value, Unit. Rows include Supply Voltage, RF Input Voltage, RF Input Frequency, Oscillator Input Voltage, Intermediate Frequency, Limiter Amp Input Voltage, Filter Amp Input Voltage, Squelch Input Voltage, Mute Sink Current, and Ambient Temperature Range.

MC3371 MC3372, A

LOW POWER FM IF

SEMICONDUCTOR TECHNICAL DATA



P SUFFIX PLASTIC PACKAGE CASE 648



D SUFFIX PLASTIC PACKAGE CASE 751B (SO-16)

PIN CONNECTIONS

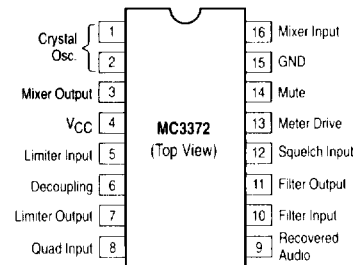
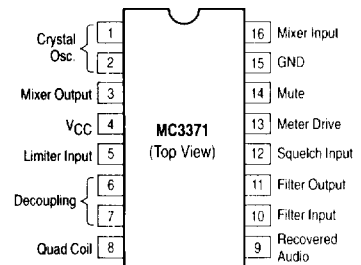

ORDERING INFORMATION

Table with 3 columns: Device, Operating Temperature Range, Package. Rows include MC3371D, MC3371P, MC3372D, AD, and MC3372P, AP.

MC3371 MC3372, A

AC ELECTRICAL CHARACTERISTICS ($V_{CC} = 4.0$ Vdc, $f_o = 58.1125$ MHz, $df = \pm 3.0$ kHz, $f_{mod} = 1.0$ kHz, 50Ω source, $f_{local} = 57.6575$ MHz, $V_{local} = 0$ dBm, $T_A = 25^\circ\text{C}$, unless otherwise noted)

Characteristic	Pin	Symbol	Min	Typ	Max	Unit
Input for 12 dB SINAD Matched Input – (See Figures 10, 11 & 12) Unmatched Input – (See Figures 7A & 7B)	–	V_{SIN}	–	1.0 5.0	– 15	μVrms
Input for 20 dB NQS	–	V_{NQS}	–	3.5	–	μVrms
Recovered Audio Output Voltage $V_{rf} = -30$ dBm	–	A_{FO}	120	200	320	mVrms
Recovered Audio Drop Voltage Loss $V_{rf} = -30$ dBm, $V_{CC} = 4.0$ V to 2.0 V	–	A_{Floss}	-8.0	-1.5	–	dB
Meter Drive Output Voltage (No Modulation) $V_{rf} = -100$ dBm $V_{rf} = -70$ dBm $V_{rf} = -40$ dBm	13	M_{Drv} MV1 MV2 MV3	– 1.1 2.0	0.3 1.5 2.5	0.5 1.9 3.1	Vdc
Filter Amp Gain $R_S = 600 \Omega$, $f_S = 10$ kHz, $V_{fa} = 1.0$ mVrms	–	$A_V(\text{Amp})$	47	50	–	dB
Mixer Conversion Gain $V_{rf} = -40$ dBm, $R_L = 1.8$ k Ω	–	$A_V(\text{Mix})$	14	20	–	dB
Signal to Noise Ratio $V_{rf} = -30$ dBm	–	s/n	36	67	–	dB
Total Harmonic Distortion $V_{rf} = -30$ dBm, BW = 400 Hz to 30 kHz	–	THD	–	0.6	3.4	%
Detector Output Impedance	9	Z_O	–	450	–	Ω
Detector Output Voltage (No Modulation) $V_{rf} = -30$ dBm	9	DV_O	–	1.45	–	Vdc
Meter Drive $V_{rf} = -100$ to -40 dBm	13	M_O	–	0.8	–	$\mu\text{A/dB}$
Meter Drive Dynamic Range RF_{In} IF_{In} (455 kHz)	13	MVD	– –	60 80	– –	dB
Mixer Third Order Input Intercept Point $f_1 = 58.125$ MHz $f_2 = 58.1375$ MHz	–	$ITOMix$	–	-22	–	dBm
Mixer Input Resistance	16	R_{in}	–	3.3	–	k Ω
Mixer Input Capacitance	16	C_{in}	–	2.2	–	pF

8

DC ELECTRICAL CHARACTERISTICS ($V_{CC} = 4.0$ Vdc, $T_A = 25^\circ\text{C}$, unless otherwise noted)

Characteristic	Pin	Symbol	Min	Typ	Max	Unit
Drain Current (No Input Signal) Squelch Off, $V_{sq} = 2.0$ Vdc Squelch On, $V_{sq} = 0$ Vdc Squelch Off, $V_{CC} = 2.0$ to 9.0 V	4	I_{cc1} I_{cc2} dI_{cc1}	– – –	3.2 3.6 1.0	4.2 4.8 2.0	mA
Detector Output (No Input Signal) DC Voltage, $V_8 = V_{CC}$	9	V_9	0.9	1.6	2.3	Vdc
Filter Output (No Input Signal) DC Voltage Voltage Change, $V_{CC} = 2.0$ to 9.0 V	11	V_{11} dV_{11}	1.5 2.0	2.5 5.0	3.5 8.0	Vdc
Trigger Hysteresis	–	Hys	34	57	80	mV

TYPICAL CURVES (UNMATCHED INPUT)

Figure 1. Total Harmonic Distortion versus Temperature

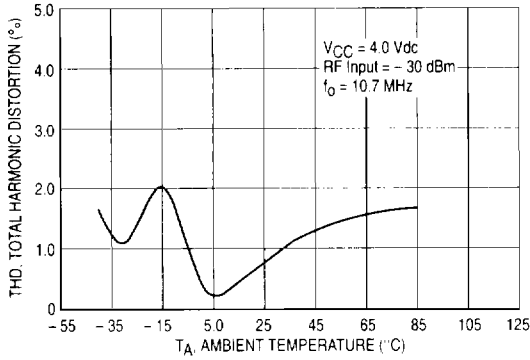

Figure 2. RSSI versus RF Input

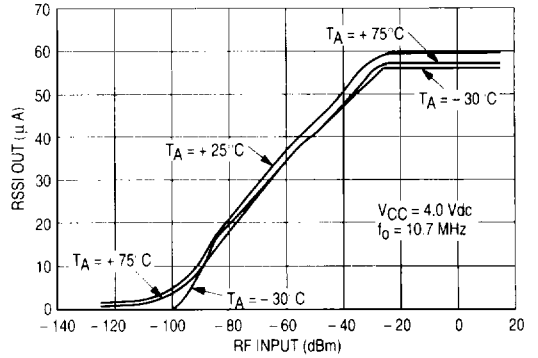

Figure 3. RSSI Output versus Temperature

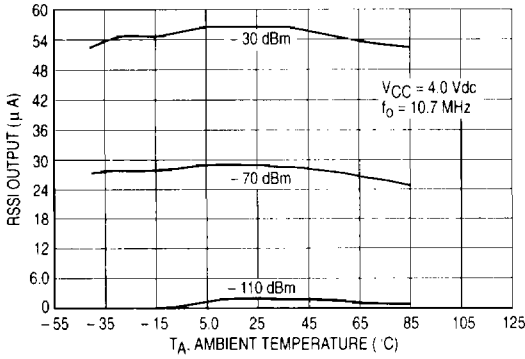

Figure 4. Mixer Output versus RF Input

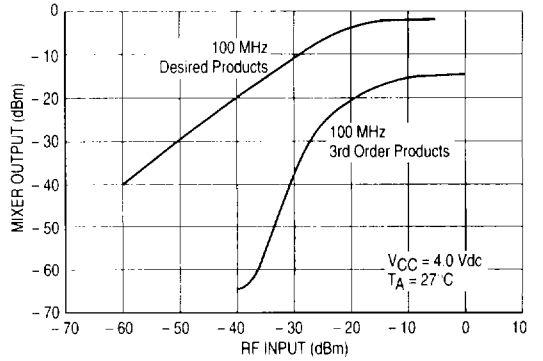

Figure 5. Mixer Gain versus Supply Voltage

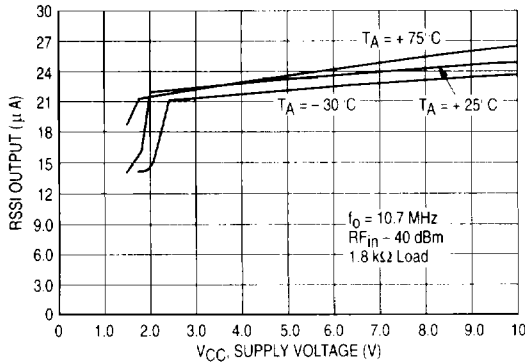
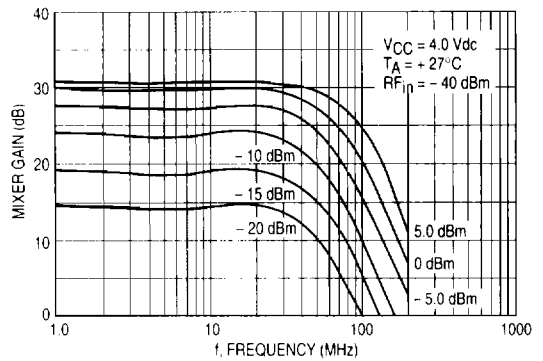

Figure 6. Mixer Gain versus Frequency



8

MC3371 MC3372, A

Figure 7B. MC3372 Functional Block Diagram and Test Fixture Schematic

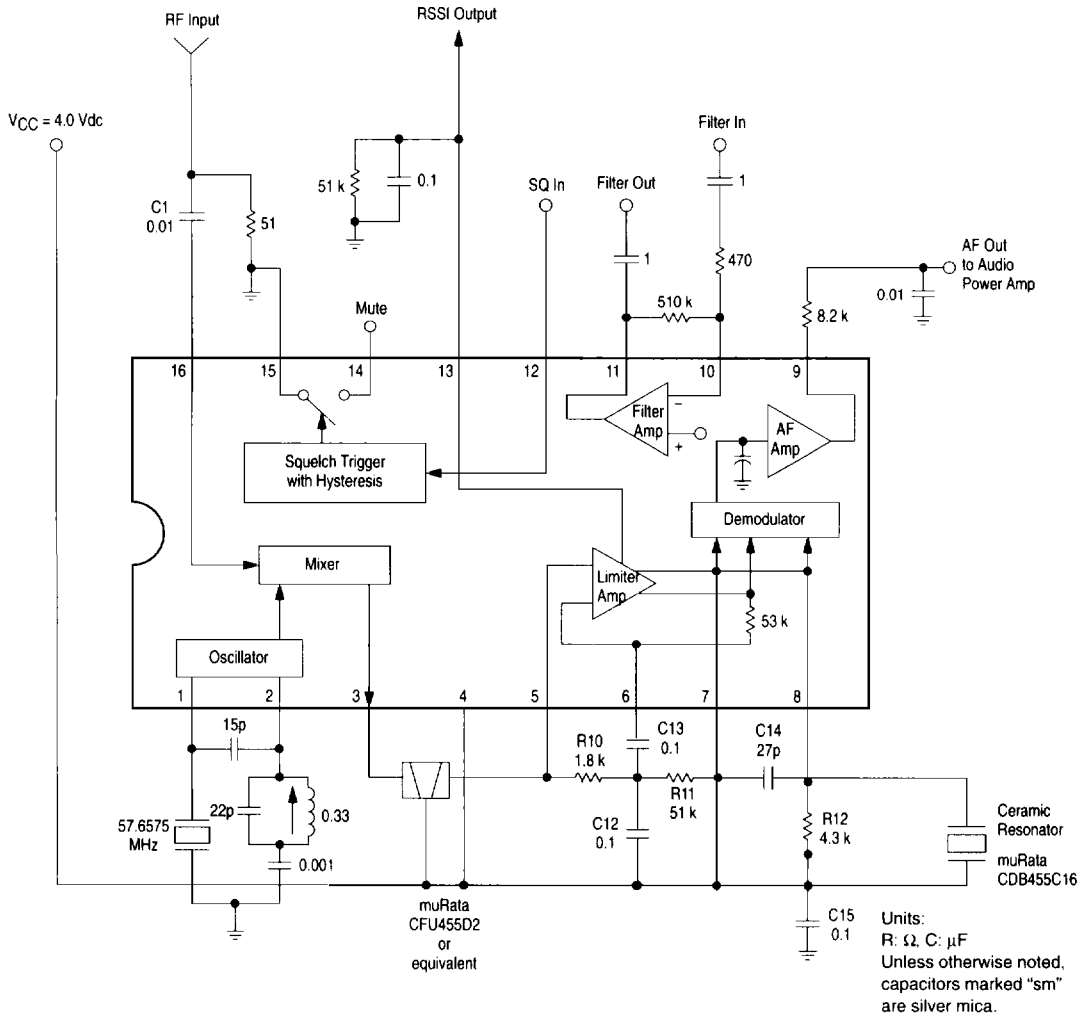







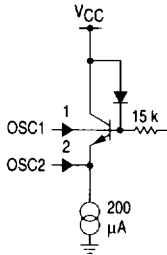
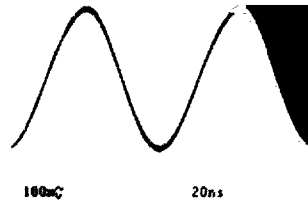
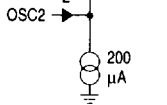
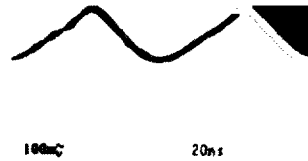
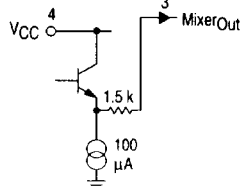

8

MC3371 MC3372, A

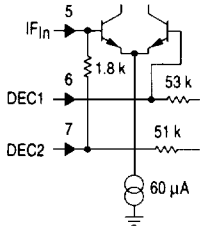
MC3371 PIN FUNCTION DESCRIPTION

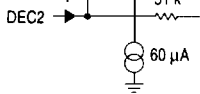
OPERATING CONDITIONS $V_{CC} = 4.0$ Vdc, $R_{FIn} = 100$ μ V, $f_{mod} = 1.0$ kHz, $f_{dev} = 3.0$ kHz, MC3371 at $f_{RF} = 10.7$ MHz (see Figure 10).

Pin	Symbol	Internal Equivalent Circuit	Description	Waveform
1	OSC1		The base of the Colpitts oscillator. Use a high impedance and low capacitance probe or a "sniffer" to view the waveform without altering the frequency. Typical level is 450 mVp-p.	
2	OSC2		The emitter of the Colpitts oscillator. Typical signal level is 200 mVp-p. Note that the signal is somewhat distorted compared to that on pin 1.	
3	MXOut		Output of the Mixer. Riding on the 455 kHz is the RF carrier component. The typical level is approximately 60 mVp-p.	
4	VCC		Supply Voltage - 2.0 to 9.0 Vdc is the operating range. VCC is decoupled to ground.	
5	IFIn		Input to the IF amplifier after passing through the 455 kHz ceramic filter. The signal is attenuated by the filter. The typical level is approximately 50 mVp-p.	
6 7	DEC1 DEC2		IF Decoupling. External 0.1 μ F capacitors connected to VCC.	

MC3371 MC3372, A

MC3371 PIN FUNCTION DESCRIPTION

OPERATING CONDITIONS $V_{CC} = 4.0$ Vdc, $R_{F_{in}} = 100 \mu V$, $f_{mod} = 1.0$ kHz, $f_{dev} = 3.0$ kHz. MC3371 at $f_{RF} = 10.7$ MHz (see Figure 10).

Pin	Symbol	Internal Equivalent Circuit	Description	Waveform
8	Quad Coil		Quadrature Tuning Coil. Composite (not yet demodulated) 455 kHz IF signal is present. The typical level is 500 mVp-p.	
9	RA		Recovered Audio. This is a composite FM demodulated output having signal and carrier component. The typical level is 1.4 Vp-p.	
			The filtered recovered audio has the carrier component removed and is typically 800 mVp-p.	
10	FilterIn		Filter Amplifier Input	
11	FilterOut		Filter Amplifier Output. The typical signal level is 400 mVp-p.	

MC3371 MC3372, A

MC3371 PIN FUNCTION DESCRIPTION









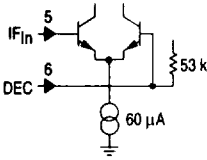

OPERATING CONDITIONS $V_{CC} = 4.0$ Vdc, $RF_{In} = 100$ μ V, $f_{mod} = 1.0$ kHz, $f_{dev} = 3.0$ kHz. MC3371 at $f_{RF} = 10.7$ MHz (see Figure 10).

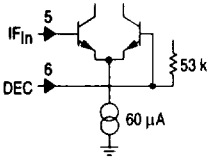
Pin	Symbol	Internal Equivalent Circuit	Description	Waveform
12	SqIn		Squelch Input. See discussion in application text.	
13	RSSI		RSSI Output. Referred to as the Received Signal Strength Indicator or RSSI. The chip sources up to 60 μ A over the linear 60 dB range. This pin may be used many ways, such as: AGC, meter drive and carrier triggered squelch circuit.	
14	MUTE		Mute Output. See discussion in application text.	
15	GND		Ground. The ground area should be continuous and unbroken. In a two-sided layout, the component side has the ground plane. In a one-sided layout, the ground plane fills around the traces on the circuit side of the board and is not interrupted.	
16	MIXIn		Mixer Input – Series Input Impedance: @ 10 MHz: $309 - j33$ Ω @ 45 MHz: $200 - j13$ Ω	

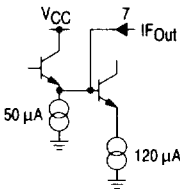
MC3371 MC3372, A

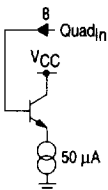
MC3372 PIN FUNCTION DESCRIPTION

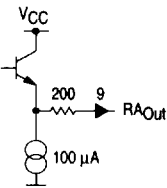
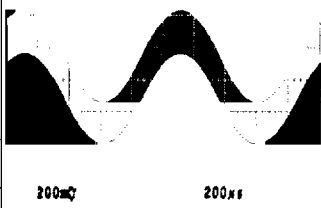
OPERATING CONDITIONS $V_{CC} = 4.0$ Vdc, $R_{FIn} = 100$ μ V, $f_{mod} = 1.0$ kHz, $f_{dev} = 3.0$ kHz. MC3372 at $f_{RF} = 45$ MHz (see Figure 12).

Pin	Symbol	Internal Equivalent Circuit	Description	Waveform
5	IF _{In}		IF Amplifier Input	
6	DEC1		IF Decoupling. External 0.1 μ F capacitors connected to V_{CC} .	
7	IF _{Out}		IF Amplifier Output Signal level is typically 300 mVp-p.	
8	Quad _{In}		Quadrature Detector Input. Signal level is typically 150 mVp-p.	
9	RA		Recovered Audio. This is a composite FM demodulated output having signal and carrier components. Typical level is 800 mVp-p.	
			The filtered recovered audio has the carrier signal removed and is typically 500 mVp-p.	

*Other pins are the same as pins in MC3371.

MC3371 MC3372, A

Figure 8. MC3371 Circuit Schematic

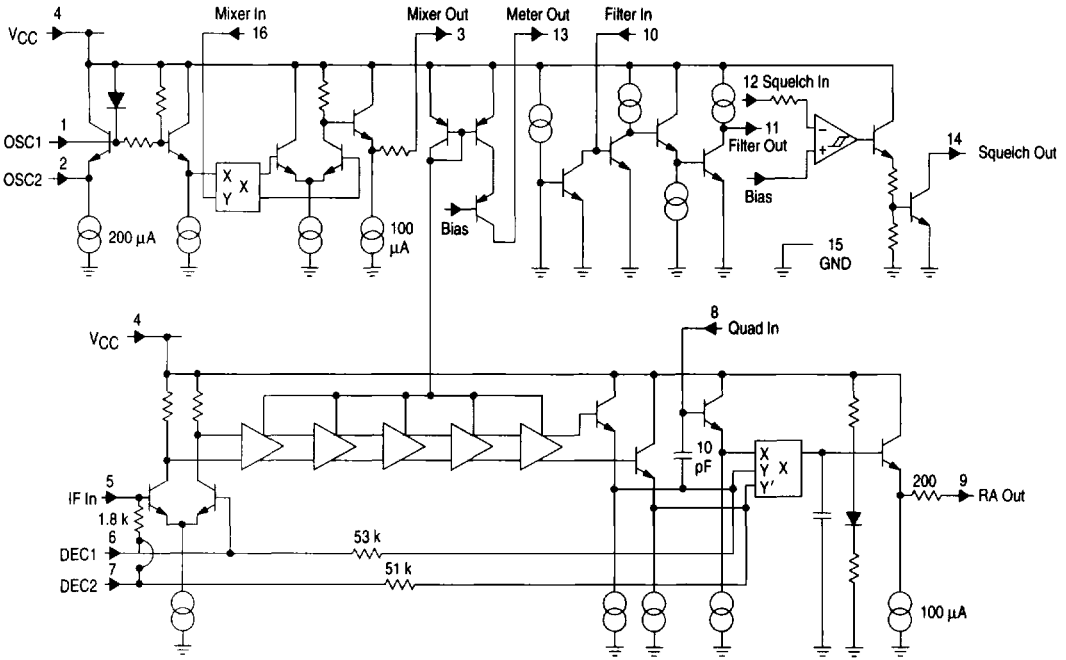
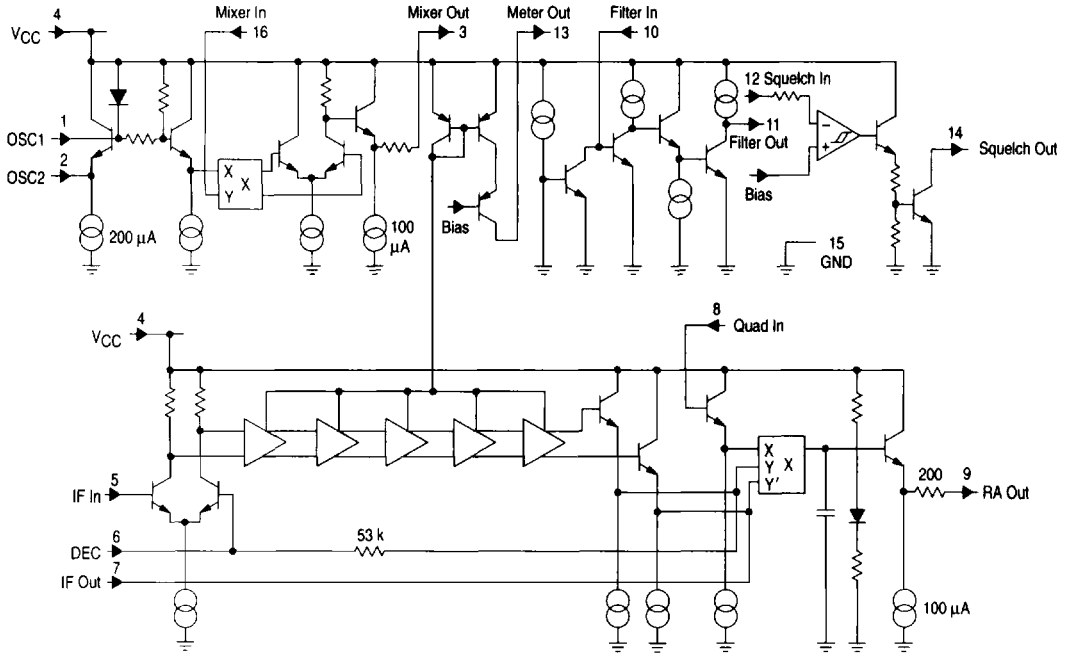

Figure 9. MC3372 Circuit Schematic



8

CIRCUIT DESCRIPTION

The MC3371 and MC3372 are low power narrowband FM receivers with an operating frequency of up to 60 MHz. Its low voltage design provides low power drain, excellent sensitivity, and good image rejection in narrowband voice and data link applications.

This part combines a mixer, an IF (intermediate frequency) limiter with a logarithmic response signal strength indicator, a quadrature detector, an active filter and a squelch trigger circuit. In a typical application, the mixer amplifier converts an RF input signal to a 455 kHz IF signal. Passing through an external bandpass filter, the IF signal is fed into a limiting amplifier and detection circuit where the audio signal is recovered. A conventional quadrature detector is used.

The absence of an input signal is indicated by the presence of noise above the desired audio frequencies. This "noise band" is monitored by an active filter and a detector. A squelch switch is used to mute the audio when noise or a tone is present. The input signal level is monitored by a meter drive circuit which detects the amount of IF signal in the limiting amplifier.

APPLICATIONS INFORMATION

The oscillator is an internally biased Colpitts type with the collector, base, and emitter connections at Pins 4, 1 and 2 respectively. This oscillator can be run under crystal control. For fundamental mode crystals use crystal characterized parallel resonant for 32 pF load. For higher frequencies, use 3rd overtone series mode type crystals. The coil (L2) and resistor RD (R13) are needed to ensure proper and stable operation at the LO frequency (see Figure 12, 45 MHz application circuit).

The mixer is doubly balanced to reduce spurious radiation. Conversion gain stated in the AC Electrical Characteristics table is typically 20 dB. This power gain measurement was made under stable conditions using a 50 Ω source at the input and an external load provided by a 455 kHz ceramic filter at the mixer output which is connected to the V_{CC} (Pin 4) and IF input (Pin 5). The filter impedance closely matches the 1.8 k Ω internal load resistance at Pin 3 (mixer output). Since the input impedance at Pin 16 is strongly influenced by a 3.3 k Ω internal biasing resistor and has a low capacitance, the useful gain is actually much higher than shown by the standard power gain measurement. The Smith Chart plot in Figure 16 shows the measured mixer input impedance versus input frequency with the mixer input matched to a 50 Ω source impedance at the given frequencies. In order to assure stable operation under matched conditions, it is necessary to provide a shunt resistor to ground. Figures 10, 11 and 12 show the input networks used to derive the mixer input impedance data.

Following the mixer, a ceramic bandpass filter is recommended for IF filtering (i.e. 455 kHz types having a bandwidth of ± 2.0 kHz to ± 15 kHz with an input and output impedance from 1.5 k Ω to 2.0 k Ω). The 6 stage limiting IF

amplifier has approximately 92 dB of gain. The MC3371 and MC3372 are different in the limiter and quadrature detector circuits. The MC3371 has a 1.8 k Ω and a 51 k Ω resistor providing internal DC biasing and the output of the limiter is internally connected, both directly and through a 10 pF capacitor to the quadrature detector; whereas, in the MC3372 these components are not provided internally. Thus, in the MC3371, no external components are necessary to match the 455 kHz ceramic filter, while in the MC3372, external 1.8 k Ω and 51 k Ω biasing resistors are needed between Pins 5 and 7, respectively (see Figures 11 and 12).

In the MC3371, a parallel LCR quadrature tank circuit is connected externally from Pin 8 to V_{CC} (similar to the MC3361). In the MC3372, a quadrature capacitor is needed externally from Pin 7 to Pin 8 and a parallel LC or a ceramic discriminator with a damping resistor is also needed from Pin 8 to V_{CC} (similar to the MC3357). The above external quadrature circuitry provides 90° phase shift at the IF center frequency and enables recovered audio.

The damping resistor determines the peak separation of the detector and is somewhat critical. As the resistor is decreased, the separation and the bandwidth is increased but the recovered audio is decreased. Receiver sensitivity is dependent on the value of this resistor and the bandwidth of the 455 kHz ceramic filter.

On the chip the composite recovered audio, consisting of carrier component and modulating signal, is passed through a low pass filter amplifier to reduce the carrier component and then is fed to Pin 9 which has an output impedance of 450 Ω . The signal still requires further filtering to eliminate the carrier component, deemphasis, volume control, and further amplification before driving a loudspeaker. The relative level of the composite recovered audio signal at Pin 9 should be considered for proper interaction with an audio post amplifier and a given load element. The MC13060 is recommended as a low power audio amplifier.

The meter output indicates the strength of the IF level and the output current is proportional to the logarithm of the IF input signal amplitude. A maximum source current of 60 μ A is available and can be used to drive a meter and to detect a carrier presence. This is referred to as a Received Strength Signal Indicator (RSSI). The output at Pin 13 provides a current source. Thus, a resistor to ground yields a voltage proportional to the input carrier signal level. The value of this resistor is estimated by $(V_{CC}(V_{dc}) - 1.0 V)/60 \mu A$; so for $V_{CC} = 4.0 V_{dc}$, the resistor is approximately 50 k Ω and provides a maximum voltage swing of about 3.0 V.

A simple inverting op amp has an output at Pin 11 and the inverting input at Pin 10. The noninverting input is connected to 2.5 V. The op amp may be used as a noise triggered squelch or as an active noise filter. The bandpass filter is designed with external impedance elements to discriminate between frequencies. With an external AM detector, the filtered audio signal is checked for a tone signal or for the presence of noise above the normal audio band. This information is applied to Pin 12.

MC3371 MC3372, A

An external positive bias to Pin 12 sets up the squelch trigger circuit such that the audio mute (Pin 14) is open or connected to ground. If Pin 12 is pulled down to 0.9 V or below by the noise or tone detector, Pin 14 is internally shorted to ground. There is about 57 mV of hysteresis at Pin 12 to prevent jitter. Audio muting is accomplished by connecting Pin 14 to the appropriate point in the audio path between Pin 9 and an audio amplifier. The voltage at Pin 14 should not be lower than -0.7 V; this can be assured by

connecting Pin 14 to the point that has no DC component.

Another possible application of the squelch switch may be as a carrier level triggered squelch circuit, similar to the MC3362/MC3363 FM receivers. In this case the meter output can be used directly to trigger the squelch switch when the RF input at the input frequency falls below the desired level. The level at which this occurs is determined by the resistor placed between the meter drive output (Pin 13) and ground (Pin 15).

Figure 10. Typical Application for MC3371 at 10.7 MHz

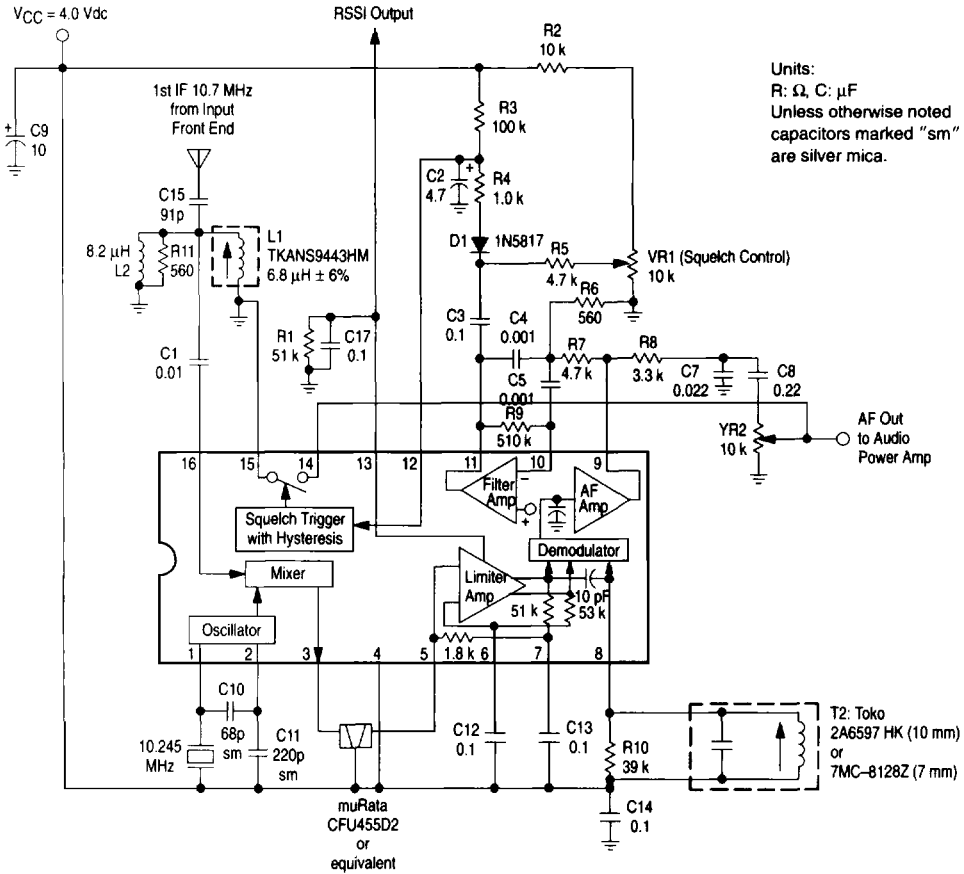

MC3371 MC3372, A

Figure 12. Typical Application for MC3372 at 45 MHz

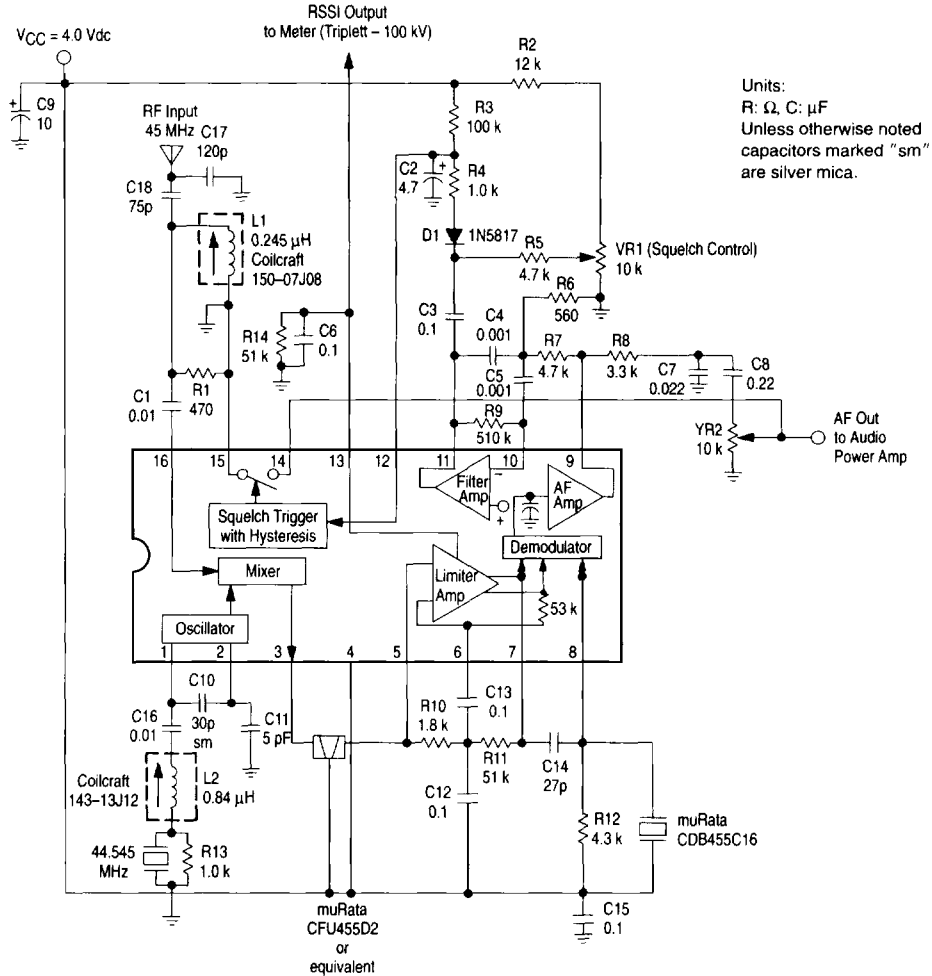

Figure 13. RSSI Output versus RF Input

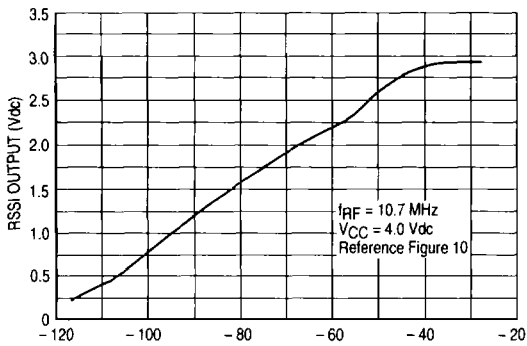
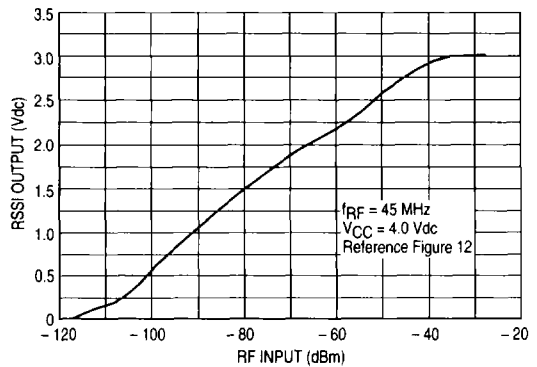

Figure 14. RSSI Output versus RF Input



MC3371 MC3372, A

Figure 15. S + N, N, AMR versus Input

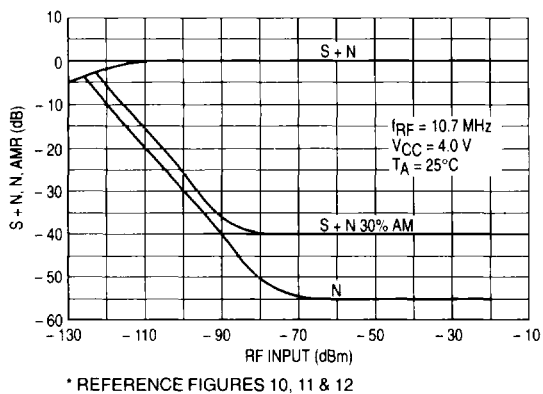
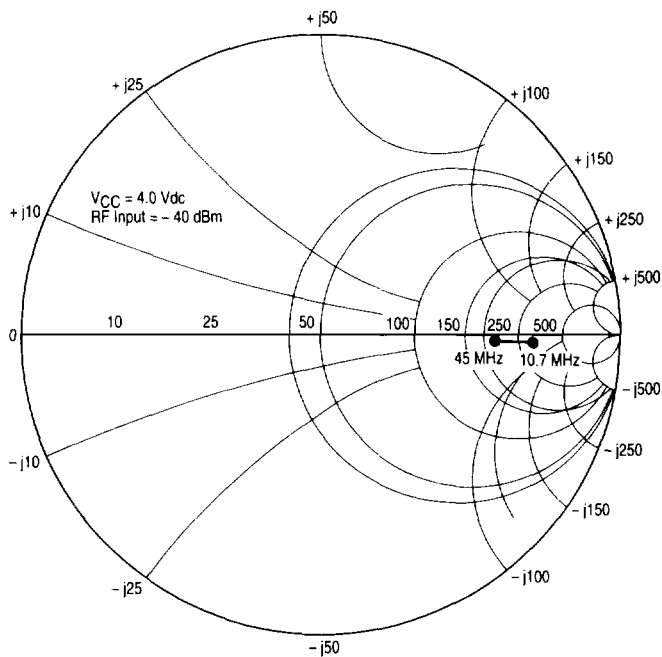

Figure 16. Mixer Input Impedance versus Frequency



8

MC3371 MC3372, A

Figure 17. MC3371 PC Board Component View with Matched Input at 10.7 MHz

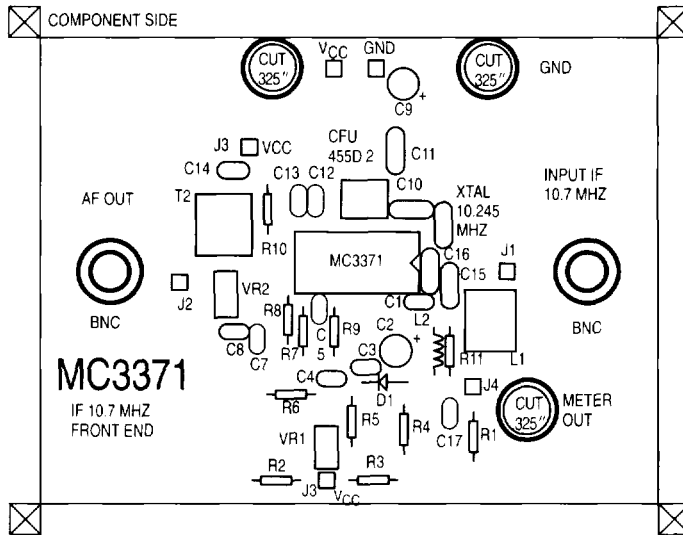
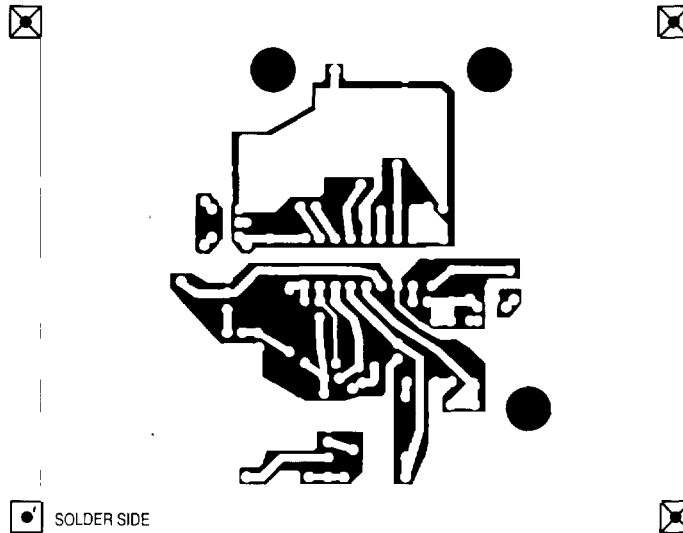

Figure 18. MC3371 PC Board Circuit or Solder Side as Viewed thru Component Side



Above PC Board is laid out for the circuit in Figure 10.

MC3371 MC3372, A

Figure 19. MC3372P PC Board Component View with Matched Input at 10.7 MHz

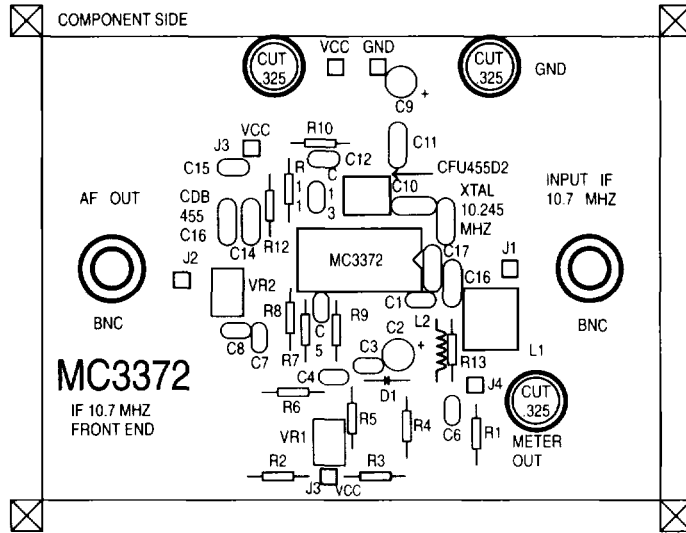

8

Figure 20. MC3372P PC Board Circuit or Solder Side as Viewed thru Component Side

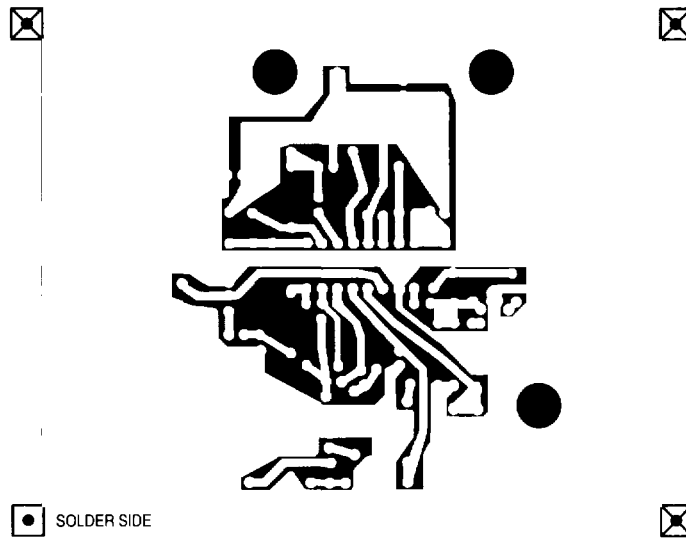

Above PC Board is laid out for the circuit in Figure 11.