

## CPDZ3V3U-HF

### RoHS Device

### Halogen Free

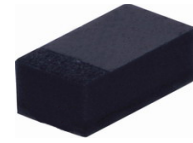

### Features

- Uni-directional ESD protection.
- Surface mount package.
- Ultra small SMD package:0201
- High component density.
- Low clamping voltage.
- Low leakage.

### Mechanical data

- Case: 0201/DFN0603 package, molded plastic.
- Terminals: Gold plated, solderable per MIL-STD-750, method 2026.
- Polarity: Color band denotes cathode end.
- Mounting position: Any

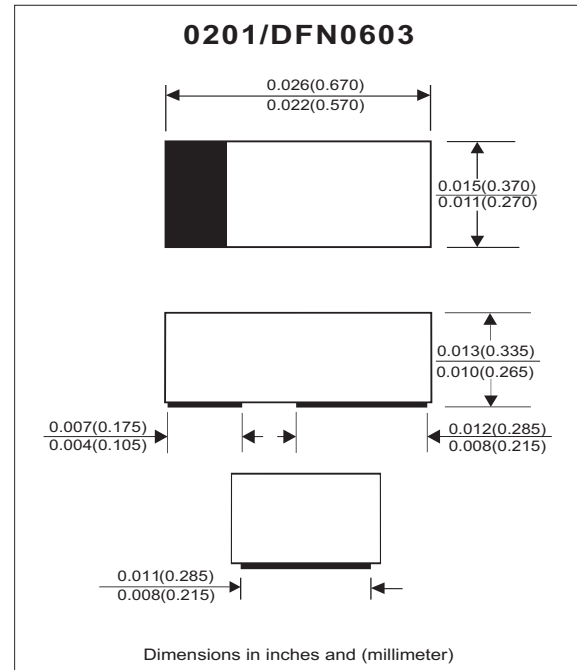

### Circuit diagram



### Maximum Rating AND Electrical Characteristics

(at TA=25°C unless otherwise noted)

Parameter	Conditions	Symbol	Min	Typ	Max	Unit
Reverse stand-off voltage		V <sub>RWM</sub>			3.3	V
Breakdown voltage	I <sub>R</sub> = 1mA	V <sub>BR</sub>	5.7	6.2	6.7	V
Forward voltage	I <sub>F</sub> = 10 mA	V <sub>F</sub>			1.2	V
Leakage current	V <sub>R</sub> = 3.3V	I <sub>L</sub>			0.1	uA
Junction capacitance	V <sub>R</sub> = 0V, f=1MHz	C <sub>T</sub>		35		pF
ESD capability	IEC 61000-4-2(air)	ESD			30	kV
	IEC 61000-4-2(contact)				30	kV
Clamping voltage	I <sub>PP</sub> = 1A, TP=8/20us	V <sub>C</sub>			7.5	V
	I <sub>PP</sub> = 6.5A, TP=8/20us				10.6	V
Peak pulse power	T <sub>P</sub> =8/20us	P <sub>PP</sub>			70	W
Operation temperature		T <sub>OP</sub>	-40		125	°C
Storage temperature		T <sub>STG</sub>	-55		150	°C

## RATING AND CHARACTERISTIC CURVES (CPDZ3V3U-HF)

Fig.1 - 8/20us Peak Pulse Current Waveform Acc. IEC 6100-4-5

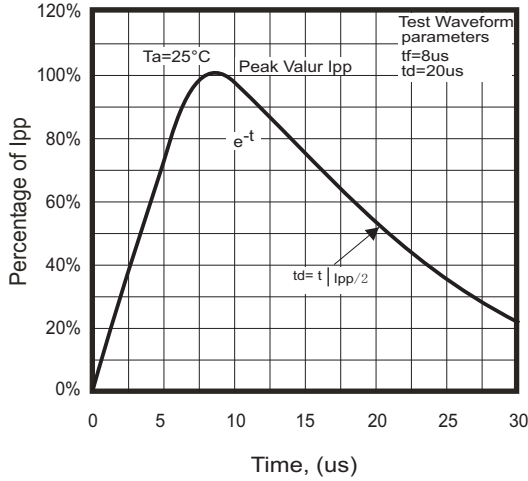

Fig.2 - Power Rating Derating Curve

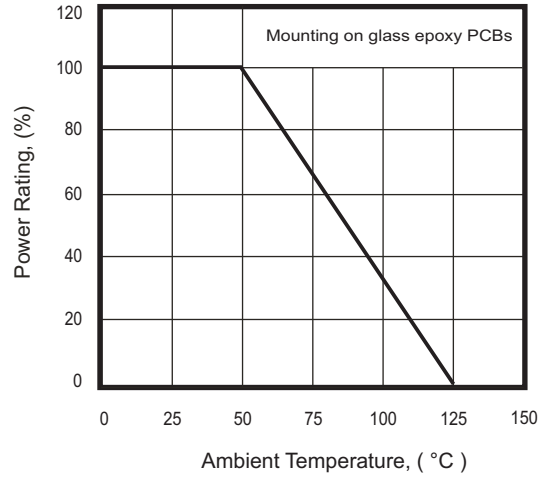

Fig.3 - Clamping Voltage Vs. Peak Pulse Current

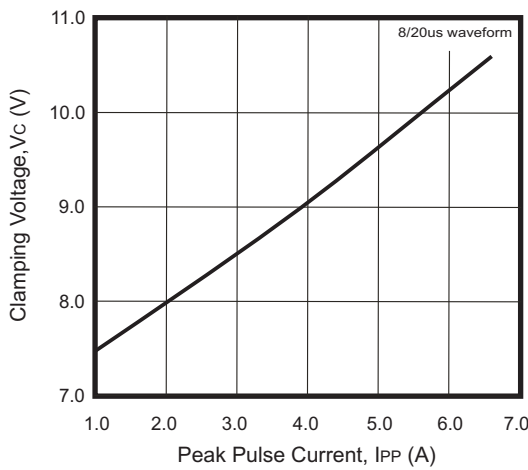

Fig.4 - Reverse Characteristics

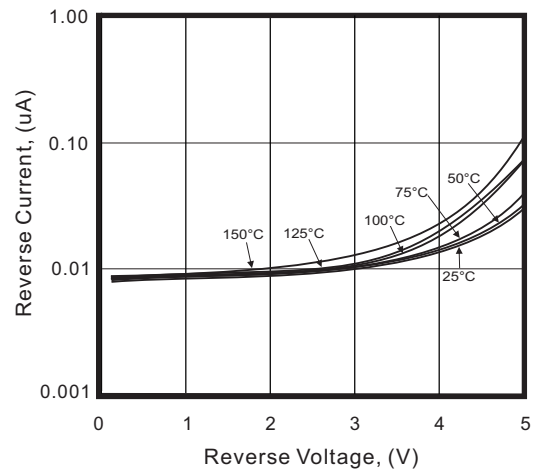
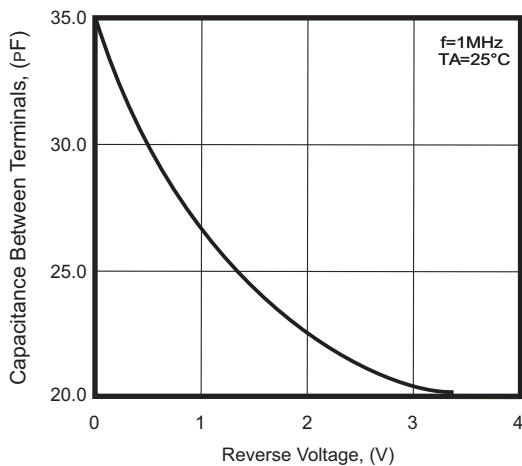

Fig.5 - Capacitance Between Terminals Characteristics



Company reserves the right to improve product design , functions and reliability without notice.

REV: B

## Reel Taping Specification

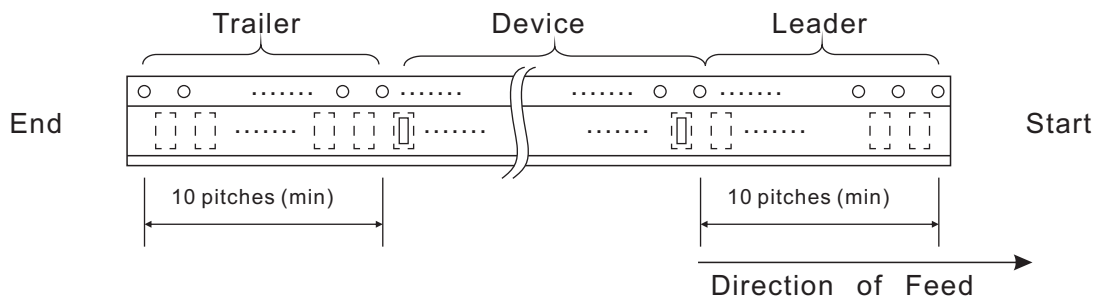
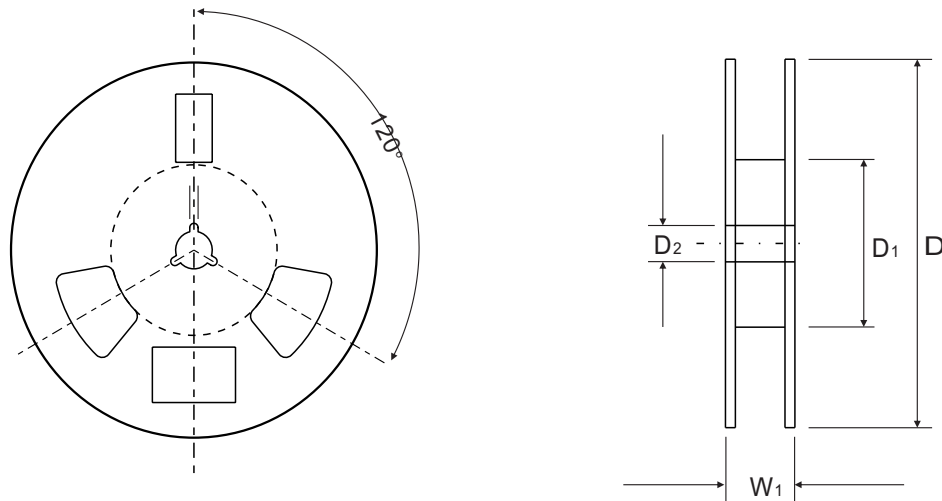
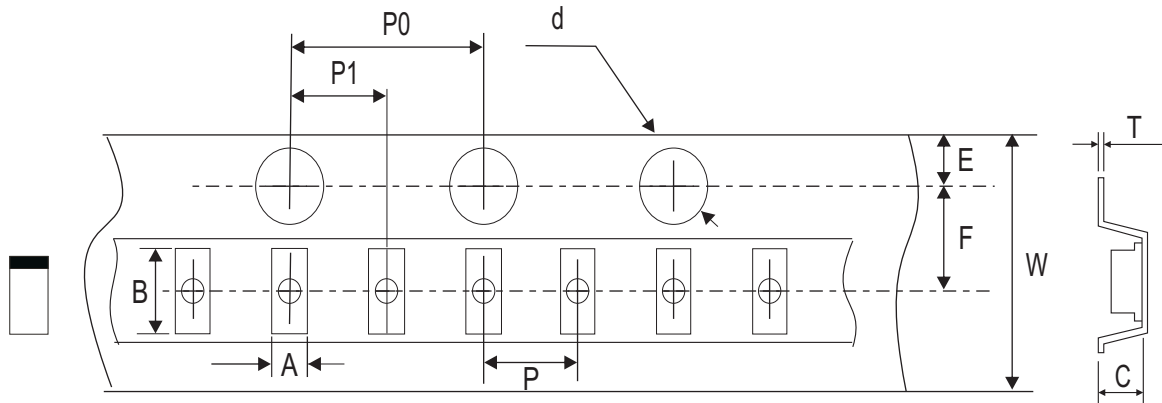

0201 (DFN0603)	SYMBOL	A	B	C	d	D	D <sub>1</sub>	D <sub>2</sub>
	(mm)	0.39 +0.03/-0.02	0.72 ± 0.03	0.36 ± 0.03	1.50 ± 0.10	178 ± 1.00	54.4 ± 0.40	13.0 ± 0.20
	(inch)	0.015 +0.001/0.001	0.028 ± 0.001	0.014 ± 0.001	0.059 ± 0.004	7.008 ± 0.039	2.142 ± 0.016	0.512 ± 0.008

0201 (DFN0603)	SYMBOL	E	F	P	P <sub>0</sub>	P <sub>1</sub>	T	W	W <sub>1</sub>
	(mm)	1.75 ± 0.10	3.50 ± 0.05	2.00 ± 0.05	4.00 ± 0.05	2.00 ± 0.05	0.23 ± 0.05	8.00 ± 0.10	12.30 ± 0.10
	(inch)	0.069 ± 0.004	0.138 ± 0.002	0.079 ± 0.004	0.157 ± 0.004	0.079 ± 0.004	0.009 ± 0.002	0.315 ± 0.008	0.484 ± 0.004

Company reserves the right to improve product design , functions and reliability without notice.

REV: B

## Marking Code

Part Number	Marking Code
CPDZ3V3U-HF	C



## Suggested PAD Layout

SIZE	0201(DFN0603)	
	(mm)	(inch)
A	0.310	0.122
B	0.200	0.079
C	0.350	0.014
D	0.150	0.006
E	0.365	0.014

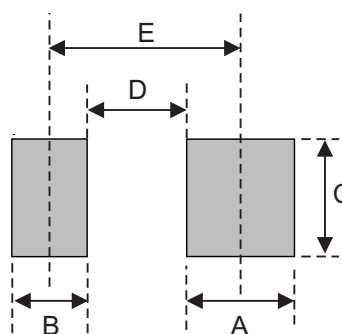

## Standard Packaging

Case Type	Qty Per Reel	Reel Size
	(Pcs)	(inch)
0201(DFN0603)	8,000	7