

Abdeckung vorverrastet
cover loose mounted

Abdeckung verpresst
cover pressed on

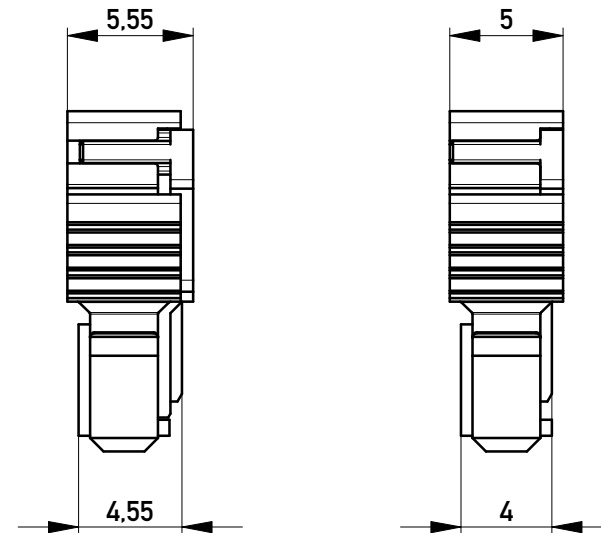

Verpackt in Tray - tray packaging
Verpackungseinheit 112 Stück - packaging unit 112

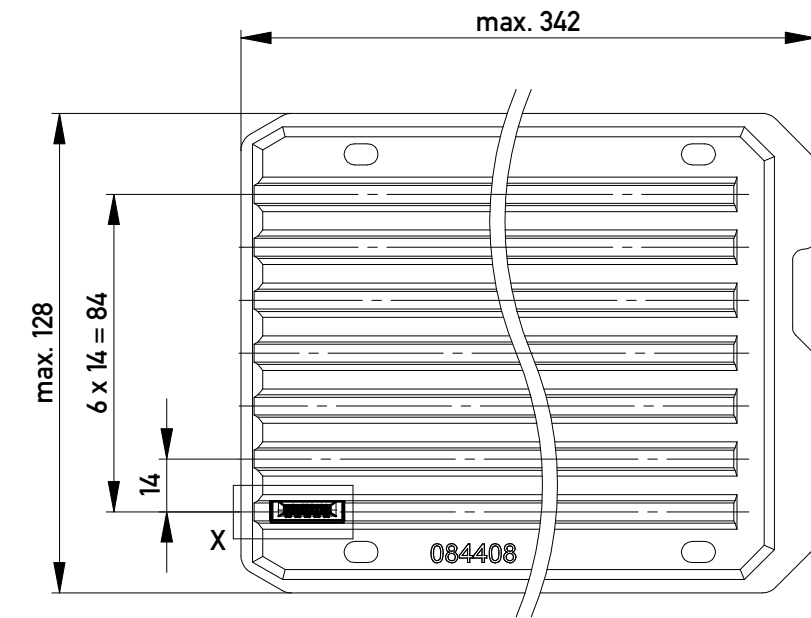

Einzelheit X
detail X

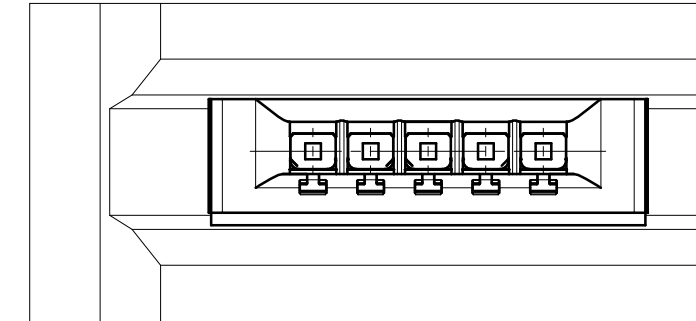

Copyright by ERNI GmbH
Proprietary notice pursuant to ISO 16016 to be observed.

Information: Codierung grün - coding green		Tolerances	All Dimensions in mm	Scale 3:1
All rights reserved. Only for Information. To ensure that this is the latest version of this drawing, please contact one of the ERNI companies before using.		Subject to modification without prior notice. Drawing will not be updated.		Designation F 2.54 SRC-A, 5-polig BA 2
c	14.05.2014		www.ERNI.com	104502070001
Index	Date			K A3
				Class SRCBUG