

Dual N-Channel, 20V, 4.8A, Power MOSFET

V _{DS} (V)	R _{ds(on)} (Ω)
20	0.016@ V _{GS} =4.5V
	0.019@ V _{GS} =3.1V
	0.022@ V _{GS} =2.5V
ESD Protected	

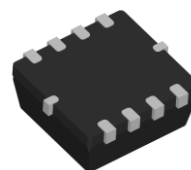

PDFN2.9x2.8-8L

Descriptions

The WNMD2162 is Dual N-Channel enhancement MOS Field Effect Transistor. Uses advanced trench technology and design to provide excellent R_{DS (ON)} with low gate charge. This device is suitable for use in DC-DC conversion, power switch and charging circuit. Standard Product WNMD2162 is Pb-free and Halogen-free.

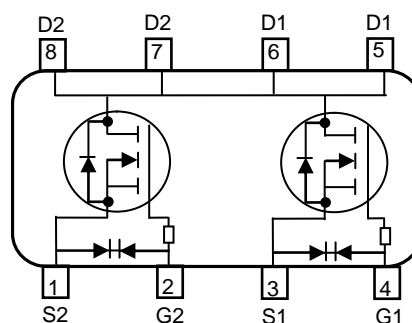

Pin configuration (Top view)

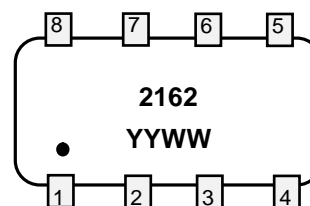

2162 = Device Code
 YY = Year
 WW = Week

Marking

Features

- Trench Technology
- Supper high density cell design
- Excellent ON resistance for higher DC current
- Extremely Low Threshold Voltage
- Small package PDFN2.9x2.8-8L

Applications

- Driver for Relay, Solenoid, Motor, LED etc.
- DC-DC converter circuit
- Power Switch
- Load Switch
- Charging

Order information

Device	Package	Shipping
WNMD2162-8/TR	PDFN 2.9×2.8-8L	3000/Reel&Tape

Absolute Maximum ratings

Parameter	Symbol	10 S	Steady State	Unit	
Drain-Source Voltage	V_{DS}	20		V	
Gate-Source Voltage	V_{GS}	± 10			
Continuous Drain Current ^{a,e}	I_D	$T_A=25^\circ\text{C}$	4.8	4.8	A
		$T_A=70^\circ\text{C}$	4.8	4.8	
Maximum Power Dissipation ^a	P_D	$T_A=25^\circ\text{C}$	1.7	1.0	W
		$T_A=70^\circ\text{C}$	1.1	0.6	
Continuous Drain Current ^{b,e}	I_D	$T_A=25^\circ\text{C}$	4.8	4.8	A
		$T_A=70^\circ\text{C}$	4.8	3.7	
Maximum Power Dissipation ^b	P_D	$T_A=25^\circ\text{C}$	1.6	0.9	W
		$T_A=70^\circ\text{C}$	1.0	0.5	
Pulsed Drain Current ^c	I_{DM}	40		A	
Operating Junction Temperature	T_J	-55~+150		$^\circ\text{C}$	
Lead Temperature	T_L	260		$^\circ\text{C}$	
Storage Temperature Range	T_{stg}	-55 to 150		$^\circ\text{C}$	

Thermal resistance ratings

Single Operation					
Parameter	Symbol	Typical	Maximum	Unit	
Junction-to-Ambient Thermal Resistance ^a	$R_{\theta JA}$	$t \leq 10 \text{ s}$	61	72	$^\circ\text{C/W}$
		Steady State	102	128	
Junction-to-Ambient Thermal Resistance ^b	$R_{\theta JA}$	$t \leq 10 \text{ s}$	65	75	
		Steady State	120	148	
Junction-to-Case Thermal Resistance	$R_{\theta JC}$	54	63		

a Surface mounted on FR-4 Board using 1 square inch pad size, 1oz copper;.

b Surface mounted on FR-4 board using minimum pad size, 1oz copper;.

c Pulse width<380 μs , Duty Cycle<2%;.

d Maximum junction temperature $T_J=150^\circ\text{C}$;

e Current rating is limited by wire-bonding.

Electronics Characteristics (Ta=25°C, unless otherwise noted)

Parameter	Symbol	Test Conditions	Min	Typ	Max	Unit
OFF CHARACTERISTICS						
Drain-to-Source Breakdown Voltage	BV_{DSS}	$V_{GS} = 0\text{ V}, I_D = 250\mu\text{A}$	20			V
Zero Gate Voltage Drain Current	I_{DSS}	$V_{DS} = 16\text{ V}, V_{GS} = 0\text{ V}$			1	μA
Gate-to-source Leakage Current	I_{GSS}	$V_{DS} = 0\text{ V}, V_{GS} = \pm 10\text{ V}$			± 5	μA
ON CHARACTERISTICS						
Gate Threshold Voltage	$V_{GS(TH)}$	$V_{GS} = V_{DS}, I_D = 250\mu\text{A}$	0.4	0.7	1.0	V
Drain-to-source On-resistance	$R_{DS(on)}$	$V_{GS} = 4.5\text{ V}, I_D = 4.8\text{ A}$		16	22	m Ω
		$V_{GS} = 3.1\text{ V}, I_D = 4.0\text{ A}$		19	28	
		$V_{GS} = 2.5\text{ V}, I_D = 3.0\text{ A}$		22	34	
Forward Transconductance	g_{FS}	$V_{DS} = 5.0\text{ V}, I_D = 4.8\text{ A}$		17		S
CHARGES, CAPACITANCES AND GATE RESISTANCE						
Input Capacitance	C_{ISS}	$V_{GS} = 0\text{ V}, f = 1.0\text{ MHz}, V_{DS} = 10\text{ V}$		1371		pF
Output Capacitance	C_{OSS}			185		
Reverse Transfer Capacitance	C_{RSS}			172		
Total Gate Charge	$Q_{G(TOT)}$	$V_{GS} = 4.5\text{ V}, V_{DS} = 10\text{ V}, I_D = 4.8\text{ A}$		18.9		nC
Threshold Gate Charge	$Q_{G(TH)}$			1.3		
Gate-to-Source Charge	Q_{GS}			2.8		
Gate-to-Drain Charge	Q_{GD}			6.4		
SWITCHING CHARACTERISTICS						
Turn-On Delay Time	$t_d(ON)$	$V_{GS} = 4.5\text{ V}, V_{DS} = 6\text{ V}, I_D = 4.8\text{ A}, R_G = 6\ \Omega$		29		ns
Rise Time	t_r			35		
Turn-Off Delay Time	$t_d(OFF)$			260		
Fall Time	t_f			125		
BODY DIODE CHARACTERISTICS						
Forward Voltage	V_{SD}	$V_{GS} = 0\text{ V}, I_S = 1.0\text{ A}$		0.65	1.5	V

Typical Characteristics (Ta=25°C, unless otherwise noted)

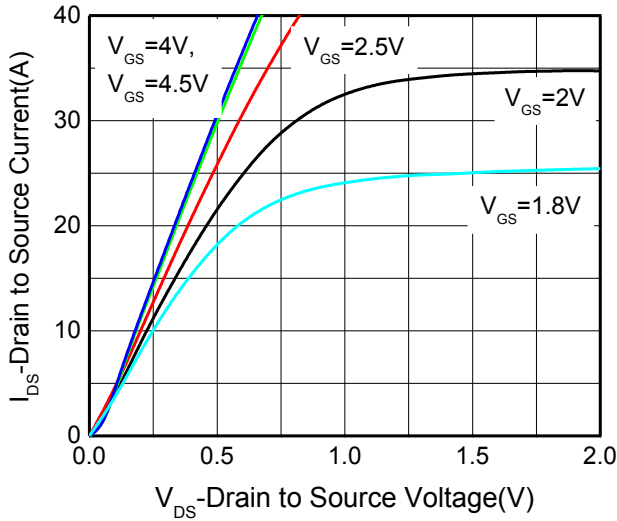

Output characteristics

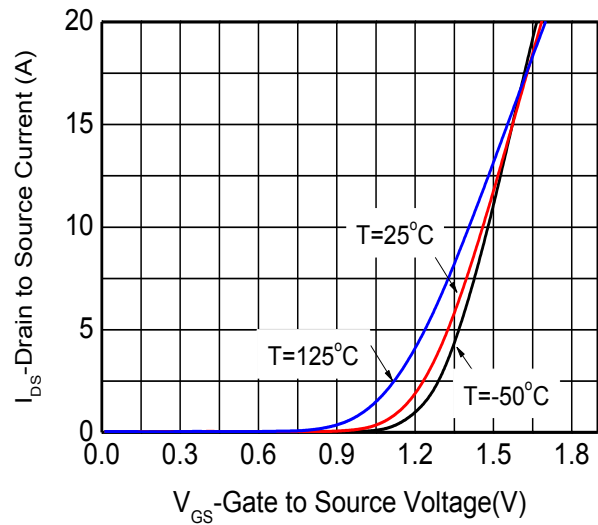

Transfer characteristics

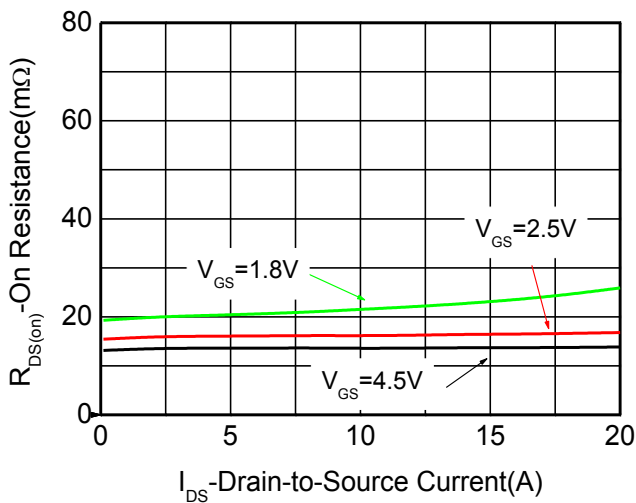

On-Resistance vs. Drain current

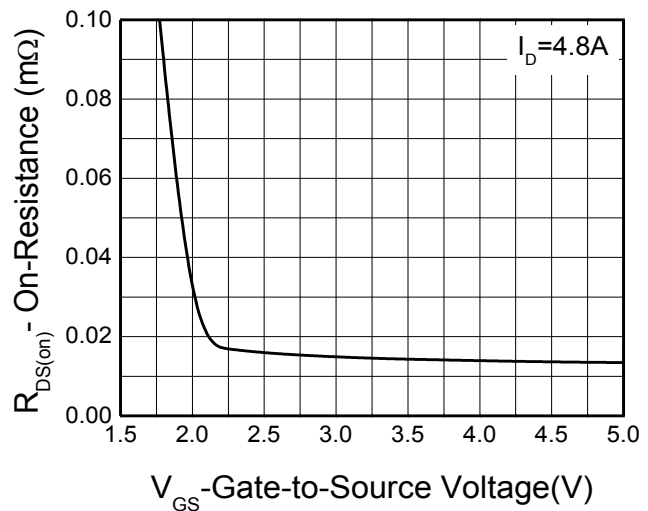

On-Resistance vs. Gate-to-Source voltage

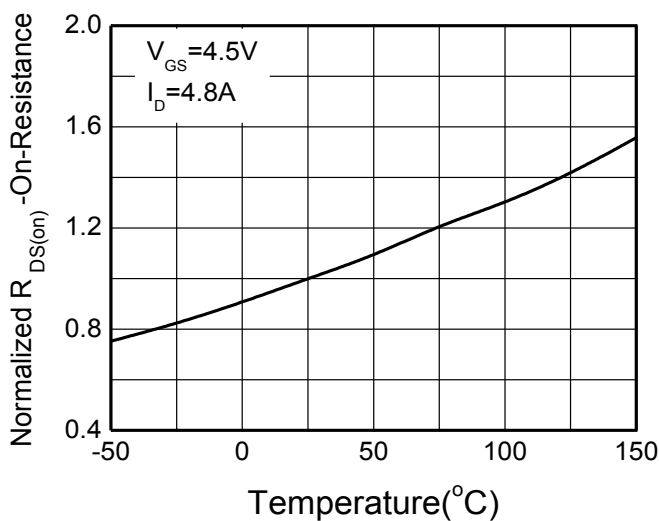

On-Resistance vs. Junction temperature

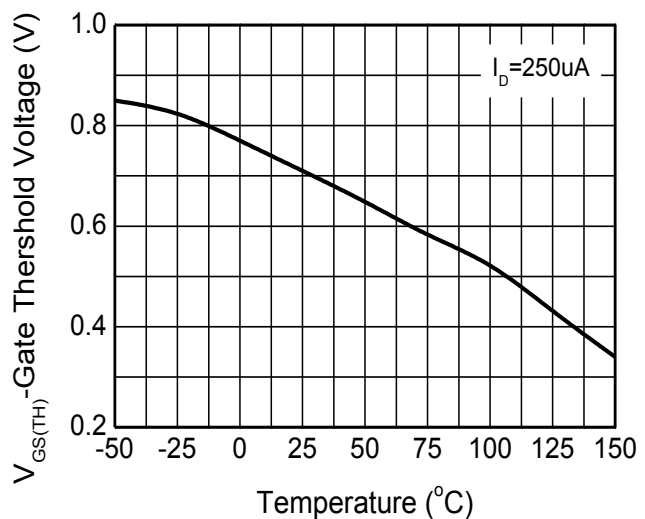

Threshold voltage vs. Temperature

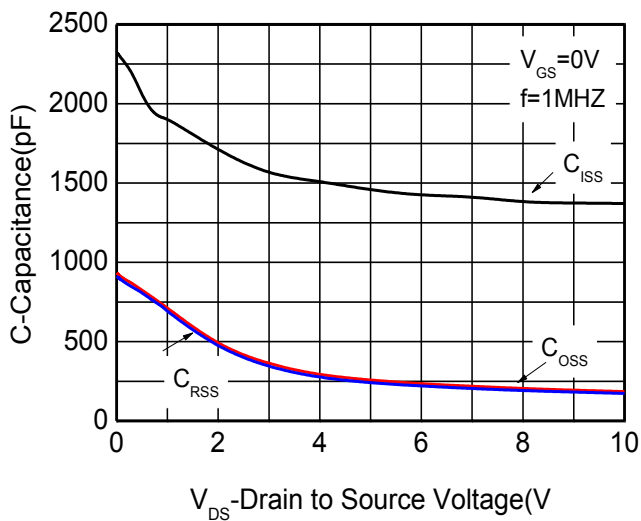

Capacitance

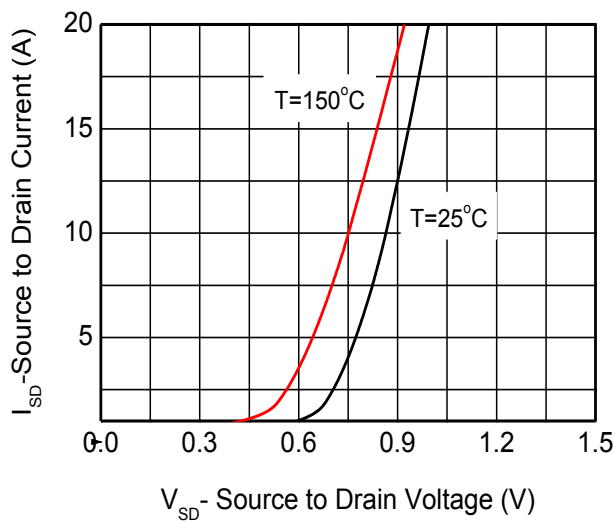

Body diode forward voltage

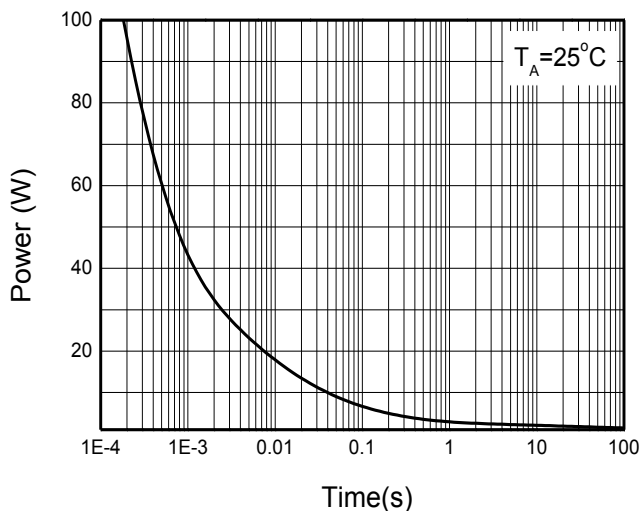

Single pulse power

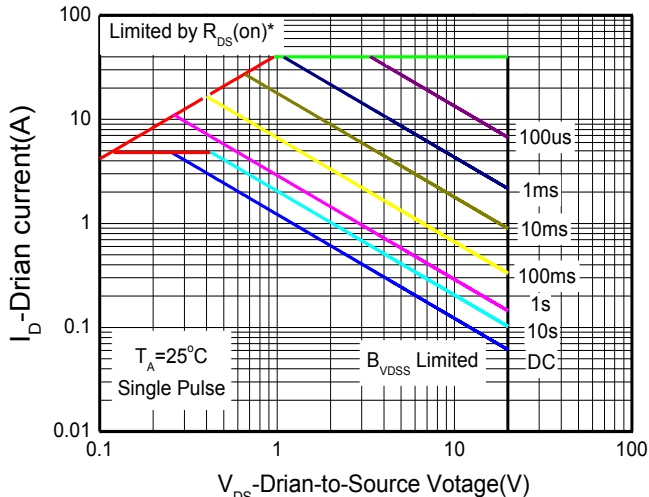

* $V_{GS} >$ minimum V_{GS} at which $R_{DS(on)}$ is specified

Safe operating power

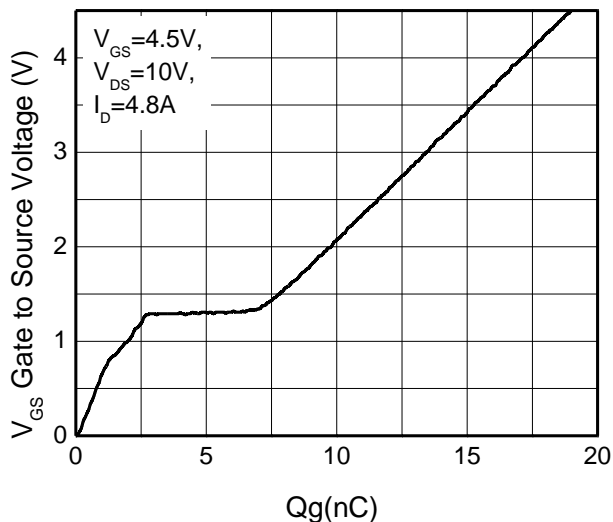

Gate Charge Characteristics

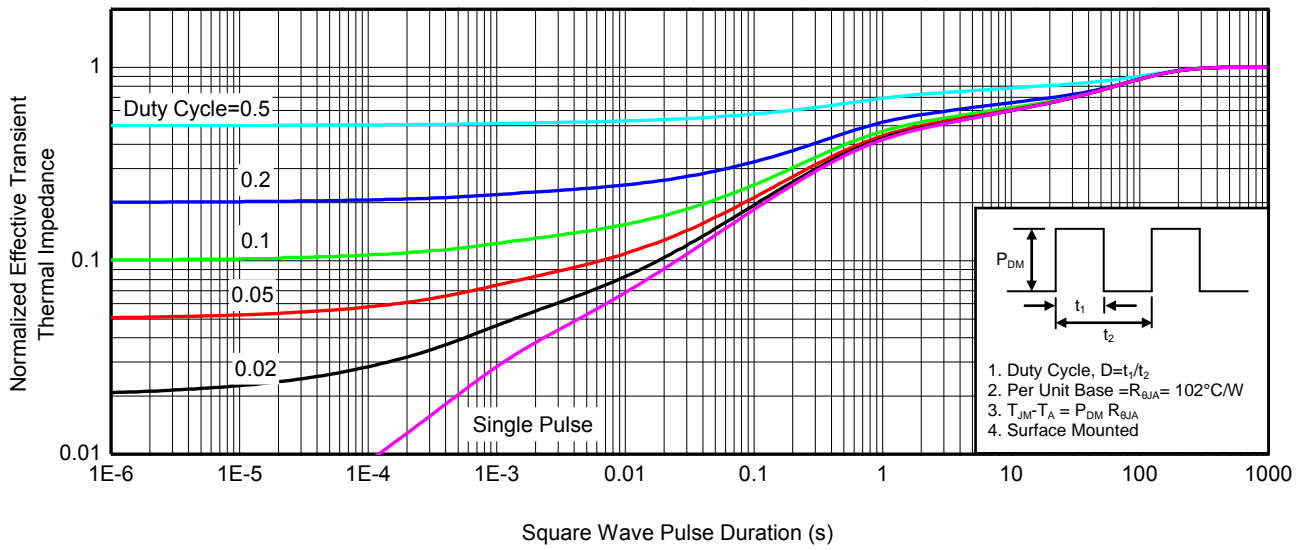

Transient thermal response (Junction-to-Ambient)

1. Duty Cycle, $D=t_1/t_2$
2. Per Unit Base $=R_{\theta JA}=102^\circ\text{C/W}$
3. $T_{JM}-T_A = P_{DM} R_{\theta JA}$
4. Surface Mounted

Package outline dimensions

PDFN2.9*2.8-8L

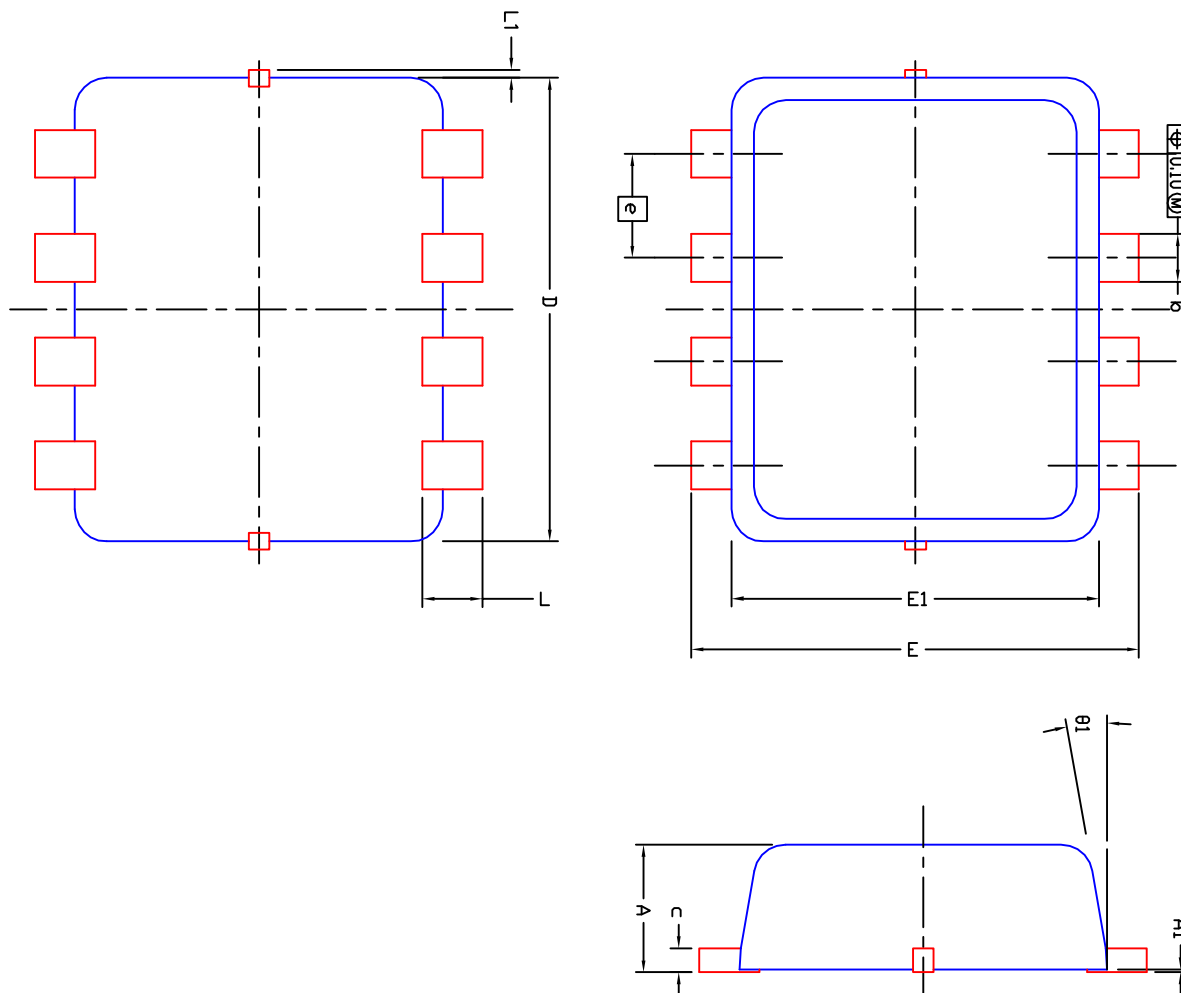

Symbol	Dimensions in millimeter		
	Min.	Typ.	Max.
A	0.700	0.800	0.900
A1	0.000	—	0.050
b	0.240	0.300	0.350
c	0.080	0.152	0.250
D	2.90 BSC		
E	2.80 BSC		
E1	2.30 BSC		
e	0.65 BSC		
L	0.200	0.375	0.450
L1	0	—	0.100
θ 1	0°	10°	12°