

Ultra Fast Avalanche SMD Rectifier

Features

- Controlled avalanche characteristic
- Glass passivated junction
- Low reverse current
- Low forward voltage
- Soft recovery characteristic
- Very fast reverse recovery time
- Good switching characteristics
- Wave and reflow solderable

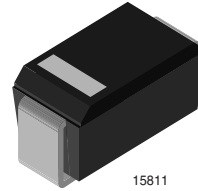

Applications

Surface mounting
 Super fast rectifier
 Freewheeling diodes in SMPS and converters
 Snubber diodes

Parts Table

Part	Type differentiation	Package
BYG22A	$V_R = 50 \text{ V @ } I_{FAV} = 2 \text{ A}$	DO-214AC
BYG22B	$V_R = 100 \text{ V @ } I_{FAV} = 2 \text{ A}$	DO-214AC
BYG22D	$V_R = 200 \text{ V @ } I_{FAV} = 2 \text{ A}$	DO-214AC

Absolute Maximum Ratings

$T_{amb} = 25 \text{ }^\circ\text{C}$, unless otherwise specified

Parameter	Test condition	Part	Symbol	Value	Unit
Reverse voltage = Repetitive peak reverse voltage		BYG22A	$V_R = V_{RRM}$	50	V
		BYG22B	$V_R = V_{RRM}$	100	V
		BYG22D		200	V
Peak forward surge current	$t_p = 10 \text{ ms}$, half sinewave		I_{FSM}	35	A
Average forward current			I_{FAV}	2	A
Junction and storage temperature range			$T_j = T_{stg}$	- 55 to + 150	$^\circ\text{C}$
Pulse energy in avalanche mode, non repetitive (inductive load switch off)	$I_{(BR)R} = 1 \text{ A}$, $T_j = 25 \text{ }^\circ\text{C}$		E_R	20	mJ

Maximum Thermal Resistance

$T_{amb} = 25\text{ }^{\circ}\text{C}$, unless otherwise specified

Parameter	Test condition	Part	Symbol	Value	Unit
Junction lead	$T_L = \text{const.}$		R_{thJL}	25	K/W
Junction ambient	mounted on epoxy-glass hard tissue		R_{thJA}	150	K/W
	mounted on epoxy-glass hard tissue, 50 mm ² 35 μm Cu		R_{thJA}	125	K/W
	mounted on Al-oxid-ceramic (Al ₂ O ₃), 50 mm ² 35 μm Cu		R_{thJA}	100	K/W

Electrical Characteristics

$T_{amb} = 25\text{ }^{\circ}\text{C}$, unless otherwise specified

Parameter	Test condition	Part	Symbol	Min	Typ.	Max	Unit
Forward voltage	$I_F = 1\text{ A}$		V_F			1	V
	$I_F = 2\text{ A}$		V_F			1.1	V
Reverse current	$V_R = V_{RRM}$		I_R			1	μA
	$V_R = V_{RRM}, T_j = 100\text{ }^{\circ}\text{C}$		I_R			10	μA
Reverse recovery time	$I_F = 0.5\text{ A}, I_R = 1\text{ A}, i_R = 0.25\text{ A}$		t_{rr}			25	ns

Typical Characteristics ($T_{amb} = 25\text{ }^{\circ}\text{C}$ unless otherwise specified)

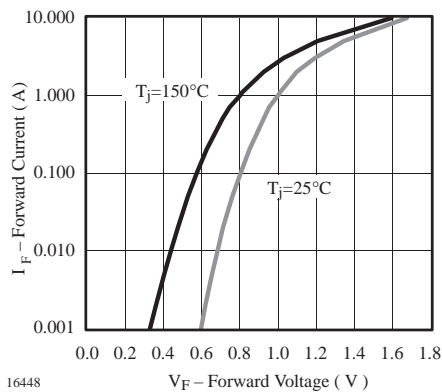

Figure 1. Forward Current vs. Forward Voltage

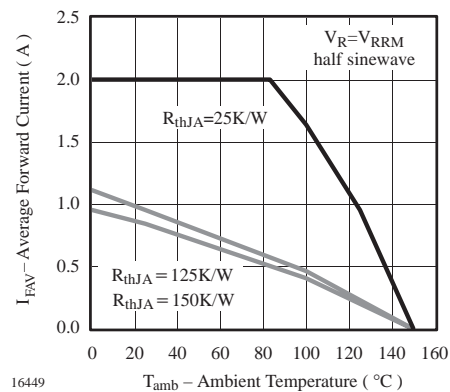

Figure 2. Max. Average Forward Current vs. Ambient Temperature

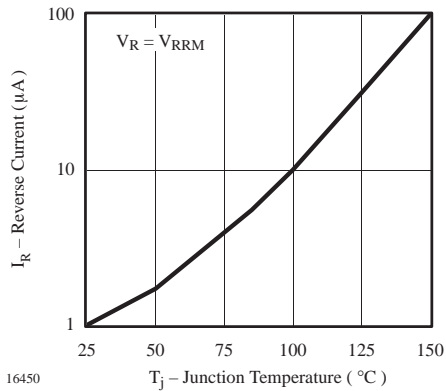

Figure 3. Reverse Current vs. Junction Temperature

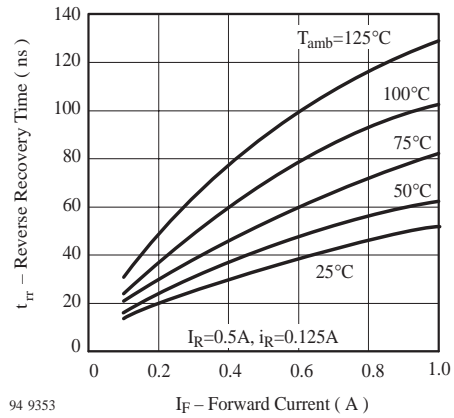

Figure 6. Max. Reverse Recovery Time vs. Forward Current

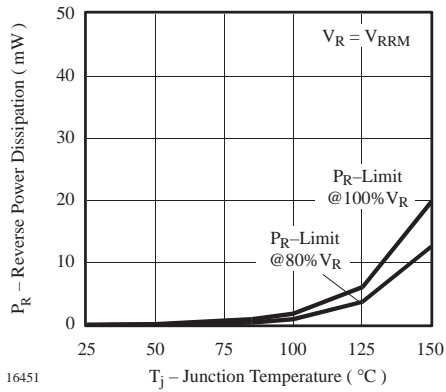

Figure 4. Max. Reverse Power Dissipation vs. Junction Temperature

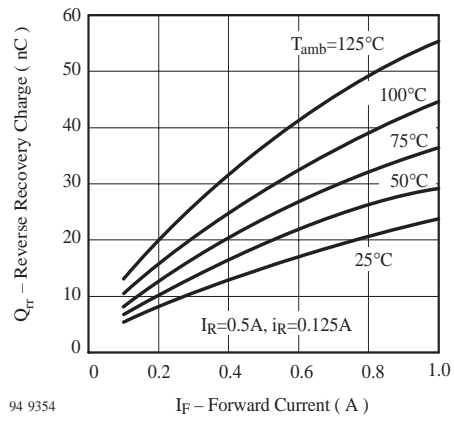

Figure 7. Max. Reverse Recovery Charge vs. Forward Current

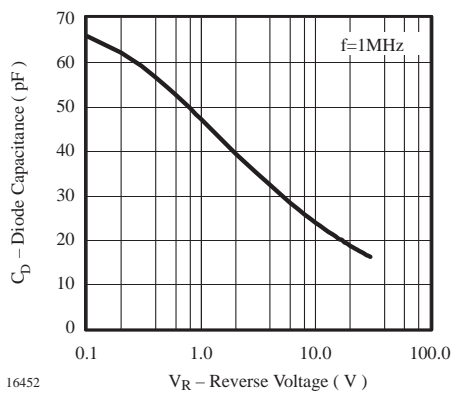

Figure 5. Diode Capacitance vs. Reverse Voltage

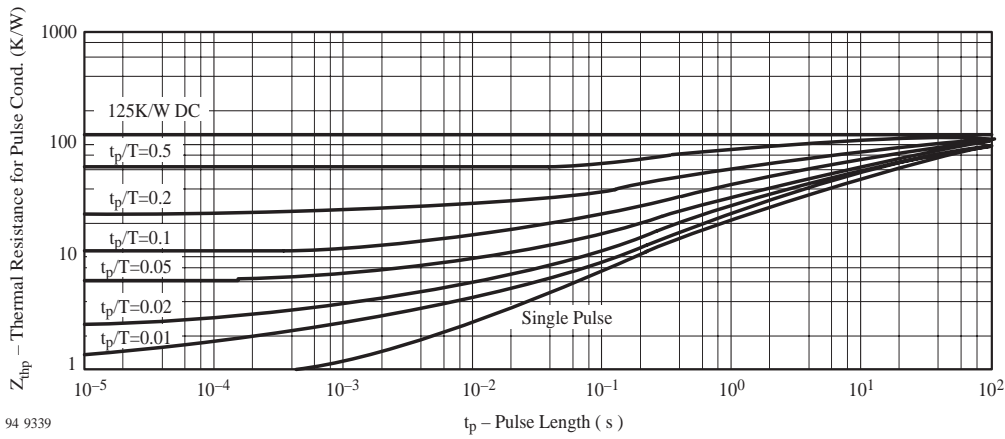
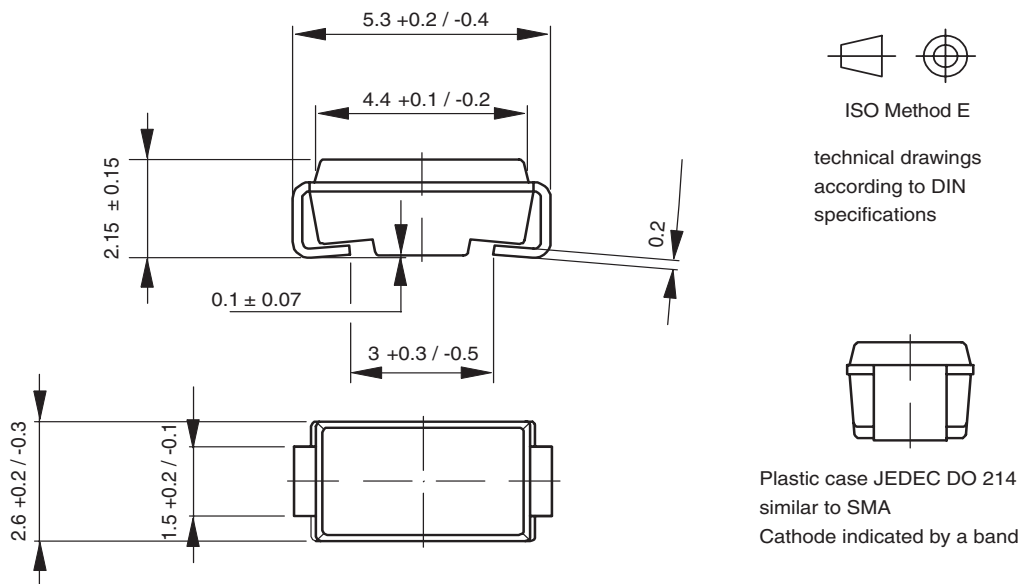

Figure 8. Thermal Response

Package Dimensions in mm (Inches)



14275-1



Notice

Specifications of the products displayed herein are subject to change without notice. Vishay Intertechnology, Inc., or anyone on its behalf, assumes no responsibility or liability for any errors or inaccuracies.

Information contained herein is intended to provide a product description only. No license, express or implied, by estoppel or otherwise, to any intellectual property rights is granted by this document. Except as provided in Vishay's terms and conditions of sale for such products, Vishay assumes no liability whatsoever, and disclaims any express or implied warranty, relating to sale and/or use of Vishay products including liability or warranties relating to fitness for a particular purpose, merchantability, or infringement of any patent, copyright, or other intellectual property right.

The products shown herein are not designed for use in medical, life-saving, or life-sustaining applications. Customers using or selling these products for use in such applications do so at their own risk and agree to fully indemnify Vishay for any damages resulting from such improper use or sale.