

20Pin

レセプタクル品番 Receptacle Model No.			適合プラグ品番 Mate Plug Model No.	
TCS5751	TCS5771	TCS5781	TCS5771 (P.9)	TCS5761 (P.9)
TCS5752	TCS5772	TCS5782	TCS5772 (P.9)	TCS5762 (P.9)
TCS5753	TCS5773	TCS5783	TCS5773 (P.9)	TCS5763 (P.9)

TCS5752

ライトアングルレセプタクル / Right Angle Receptacle

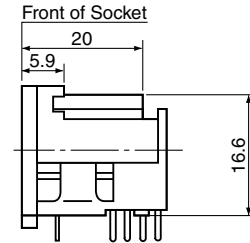
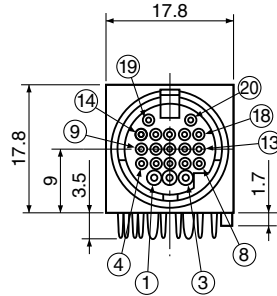
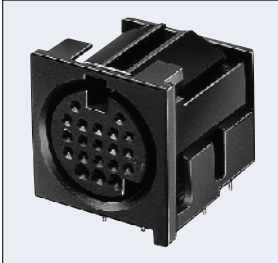

TCS5771

ライトアングルレセプタクル / Right Angle Receptacle

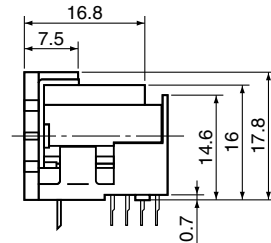
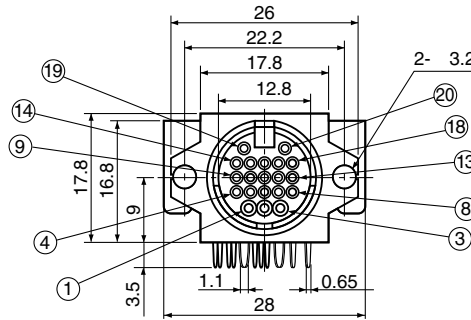
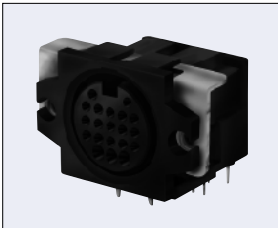

TCS5781

ライトアングルレセプタクル / Right Angle Receptacle

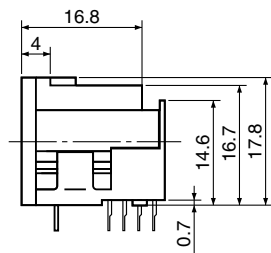
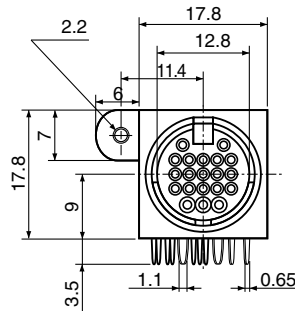
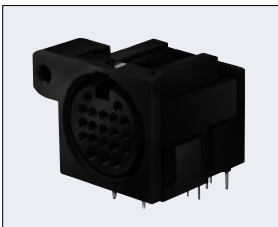

誤挿入防止キー位置 Faulty Insertion Prevention Key Position	(A) Position	(B) Position	(C) Position
プリント基板パターン図 Recommended PCB Layout (Mottom View)	<p>Fig.1</p>	<p>Fig.2</p>	<p>Fig.3</p>
Model No.	TCS5751-014151 TCS5771-014151 TCS5781-014151	TCS5752-014151 TCS5772-014151 TCS5782-014151	TCS5753-014151 TCS5773-014151 TCS5783-014151