

# Panasonic

ideas for life

## AZ5 Limit Switch

### Limit Switches



Limit Switches '06-'07

These materials are printed on ECF pulp.  
These materials are printed with earth-friendly vegetable-based (soybean oil) ink.



Please contact .....

### Matsushita Electric Works, Ltd.

Automation Controls Business Unit  
■ Head Office: 1048, Kadoma, Kadoma-shi, Osaka 571-8686, Japan  
■ Telephone: +81-6-6908-1050 ■ Facsimile: +81-6-6908-5781  
<http://www.nais-e.com/>



All Rights Reserved © 2006 COPYRIGHT Matsushita Electric Works, Ltd.

Matsushita Electric Works, Ltd.

Limit Switches  
ARCT1B272E '06.9

General use vertical limit switch. Type with a lamp which makes maintenance convenient; either a neon AC powered lamp or an LED DC powered lamp.

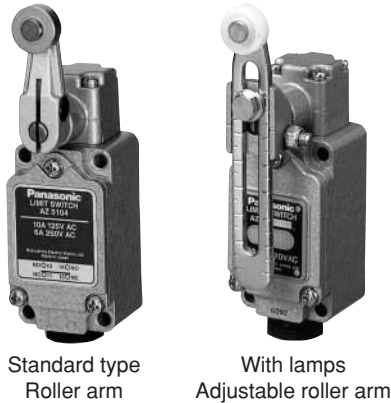

RoHS Directive compatibility information  
<http://www.nais-e.com/>

**FEATURES**

1. Can be mounting either front or back.

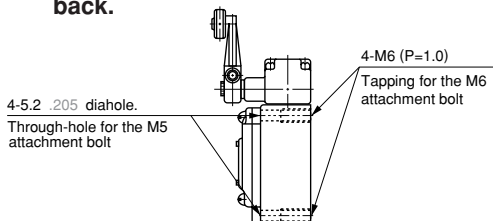

2. Lamps that can be used with a wide range of voltages

- Neon lamp  
Comes in two types: 100V AC and 200V AC, sufficient luminosity is achieved through the diamond-cut lens. Also with a long lifespan of more than 20 thousand hours.

- LED lamp  
Covers 6V to 48V and comes in three types, 6V AC/DC, 12V AC/DC, and 24 to 48V AC/DC. Uses two highly luminous LEDs and in addition, sufficient luminosity is achieved through the diamond-cut lens.

3. Lamp connection can be either spring type or lead wire type

- Spring type (wiring unnecessary) (With neon or LED lamp type)  
Wiring is unnecessary because the lamp is directly connected to the terminals. By simply changing the direction of the lamp cover, it is possible to display both lights during operation (normally closed side) and no operation (normally open side.)

- Lead wiring type <Current leakage: 0> (LED type only)

Because the wiring can be made parallel to the load, current leakage from the lamp can be reduced to 0. Even with a slight leak, the electronic circuit incurring the leak can be used safely.

4. Corrosion-proof, oil-resistant construction

The protective construction is corrosion-proof (conforms to IP67.) Also, the lens and cover are formed simultaneously with the lamp type, and moreover, a nameplate is affixed to the upper surface, thereby improving the already-excellent waterproof capabilities.

**TYPICAL APPLICATIONS**

Conveyer equipment, conveyer belts, plant facilities, cranes, cleaning plants, etc. The LED lamp type is also compatible with both PC and computer direct current low voltage control circuits.

**PRODUCT TYPE**

1. Standard type

Actuator		Part No.
Push plunger		AZ5101
Roller plunger		AZ5102
Roller arm	Standard type	AZ5104
	O.T. amplified type	AZ5124
Yoke		AZ5105
Flexible		AZ5106
Adjustable rod	Standard type	AZ5107
	O.T. amplified type	AZ5127
Adjustable roller arm	Standard type	AZ5108
	O.T. amplified type	AZ5128

2. With neon lamp

Lamp connection	Actuator	Lamp rating		
		100V AC	200V AC	
		Part No.		
Spring type	Push plunger	AZ510141	AZ510142	
	Roller plunger	AZ510241	AZ510242	
	Roller arm	Standard type	AZ510441	AZ510442
		O.T. amplified type	AZ512441	AZ512442
	Yoke	AZ510541	AZ510542	
	Flexible	AZ510641	AZ510642	
	Adjustable rod	Standard type	AZ510741	AZ510742
		O.T. amplified type	AZ512741	AZ512742
	Adjustable roller arm	Standard type	AZ510841	AZ510842
		O.T. amplified type	AZ512841	AZ512842

## 3. With LED

Lamp connection	Actuator		Lamp rating	
			12V DC	24 to 48V DC
			Part No.	
Spring type	Push plunger		AZ5101161	AZ510116
	Roller plunger		AZ5102161	AZ510216
	Roller arm	Standard type	AZ5104161	AZ510416
		O.T. amplified type	AZ5124161	AZ512416
	Yoke		AZ5105161	AZ510516
	Flexible		AZ5106161	AZ510616
	Adjustable rod	Standard type	AZ5107161	AZ510716
		O.T. amplified type	AZ5127161	AZ512716
	Adjustable roller arm	Standard type	AZ5108161	AZ510816
O.T. amplified type		AZ5128161	AZ512816	
Lead wire type	Push plunger		AZ5101661	AZ510166
	Roller plunger		AZ5102661	AZ510266
	Roller arm	Standard type	AZ5104661	AZ510466
		O.T. amplified type	AZ5124661	AZ512466
	Yoke		AZ5105661	AZ510566
	Flexible		AZ5106661	AZ510666
	Adjustable rod	Standard type	AZ5107661	AZ510766
		O.T. amplified type	AZ5127661	AZ512766
	Adjustable roller arm	Standard type	AZ5108661	AZ510866
O.T. amplified type		AZ5128661	AZ512866	

Note) Cadmium free contact types are available on a custom-made basis. Please add an "F" to the end of the part number when ordering.  
LED rating 6V DC type is available. When ordering, add suffix 162 (spring type) or 662 (lead wire type) to the standard part No..

## SPECIFICATIONS

### 1. Rating

#### 1) Standard type

Types of load Rated load	Resistive load (cos φ ≈ 1)	Inductive load (cos φ ≈ 0.4)	Motor or lamp load	
			N.C. contact	N.O. contact
125V AC	10A	6A	4A	2A
250V AC	6A	4A	2.5A	1.2A
500V AC	2A	1.2A	0.75A	0.5A
125V DC	0.8A	0.1A	-	-

#### 2) Type with lamp

	Rated control voltage	Resistive load (cos φ ≈ 1)	Inductive load (cos φ ≈ 0.4)
With neon lamp	125V AC	10A	6A
	240V AC	6A	4A
With LED	24V DC	6A	-

### 2. Characteristics

Contact arrangement	1 Form A 1Form B	
Initial contact resistance, max.	15mΩ (By voltage drop 6 to 8V DC 1A)	
Contact material	Silver	
Initial insulation resistance (At 500V DC)	Min. 100MΩ	
Initial breakdown voltage	1,000Vrms for 1 min Between non-secutive terminals 2,000Vrms for 1 min Between dead metal parts and each terminal 2,000Vrms for 1 min Between ground and each terminal	
Shock resistance	294m/s <sup>2</sup> {30G}	
Vibration resistance	Standard type: Max. 55Hz Type with indicator: 10 to 50 Hz, double amplitude of 1.5mm	
Expected life (Min. operations)	Mechanical	10 <sup>7</sup> (at 60 cpm)
	Electrical	5 × 10 <sup>5</sup> (at 20 cpm, rated load)
Ambient temperature	Standard type: -5 to +80°C +23 to +176°F With indicator: -5 to +60°C +23 to +140°F	
Ambient humidity	Max. 95%R.H.	
Max. operating speed	120 cpm	

### 3. Operating characteristics

Characteristics	O.F. (N {gf}) max.	R.F. (N {gf}) min.	Pretravel (P.T.), max. mm inch	Movement Differential (M.D.), max. mm inch	Overtravel (O.T.), min. mm inch	Totaltravel (T.T.), min.	Repeat Accuracy of Operating Position, max. mm inch <sup>*1</sup>	
								Actuator
Push plunger	26.67 {2,720}	8.92 {910}	1.7 .067	1.0 .039	6.4 .252	-	0.1 .004	
Roller plunger	26.67 {2,720}	8.92 {910}	1.7 .067	1.0 .039	5.6 .220	-	0.1 .004	
Roller arm	Standard type	13.34 {1,360}	2.23 {227}	15°±5°	12°	-	45°	1°
	O.T. amplified type	8.83 {900}	0.49 {50}	25°±5°	15°	-	90°	1°
Yoke	8.90 {908}	8.90 {908}	50°±5°	-	-	90°±10°	-	
Flexible <sup>*2</sup>	1.39 {142}	-	20±10 .787±.394	-	-	-	-	
Adjustable rod <sup>*3</sup>	Standard type	1.39 {142}	0.27 {28}	15°±5°	12°	-	45°	1°
	O.T. amplified type	2.39 {244}	0.14 {14}	25°±5°	15°	-	90°	1°
Adjustable roller arm <sup>*4</sup>	Standard type	13.34 {1,360}	2.23 {227}	15°±5°	12°	-	45°	1°
	O.T. amplified type	8.83 {900}	0.49 {50}	25°±5°	15°	-	90°	1°

\*1) Value between max. and min. value in the operating position at 20 cpm, no-load  
\*2) Measured at the position within 5mm from the top of actuator.  
\*3) O.F., R.F.: measured at the center distance of 135mm 5.315inch.  
\*4) O.F., R.F.: measured at the center distance of 38mm 1.496inch.  
\*5) For the operating characteristics, refer to the TECHNICAL INFORMATION.

### 4. Protective characteristics

Protective construction IEC	AZ5 limit switches (Standard type)	AZ5 limit switches (With lamp) (neon/LED)
IP60	○	○
IP64	○	○
IP67	○	○

### 5. Lamp rating

Types	Rated operating voltage	Operating voltage range	Internal resistance
neon lamp	100V AC	80 to 120V AC	120kΩ
	200V AC	160 to 240V AC	240kΩ
LED lamp	6V AC/DC	5 to 15V AC/DC	2.4kΩ
	12V AC/DC	9 to 28V AC/DC	4.7kΩ
	24 to 48V AC/DC	20 to 55V AC/DC	15kΩ

## FOREIGN STANDARD

Standard	Applicable product	Part No.	Notes
UL recognized product	File No. : E99838 Ratings : 10A, 1/2HP, 125V AC 6A, 1/2HP, 250V AC Product type : standard model only	Add "9" to the end of the standard part No.	Please ask about the price. Comes fitted with an earth pin.

# WIRING DIAGRAM

Output circuit

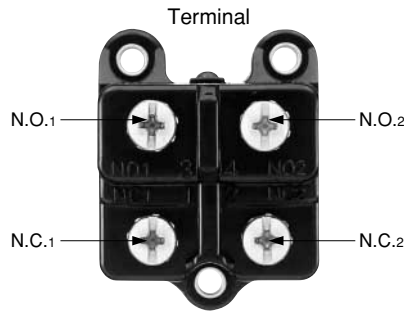
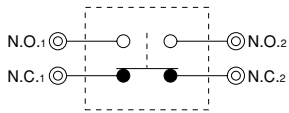

# DIMENSIONS

• Push plunger  
Standard type



AZ5101

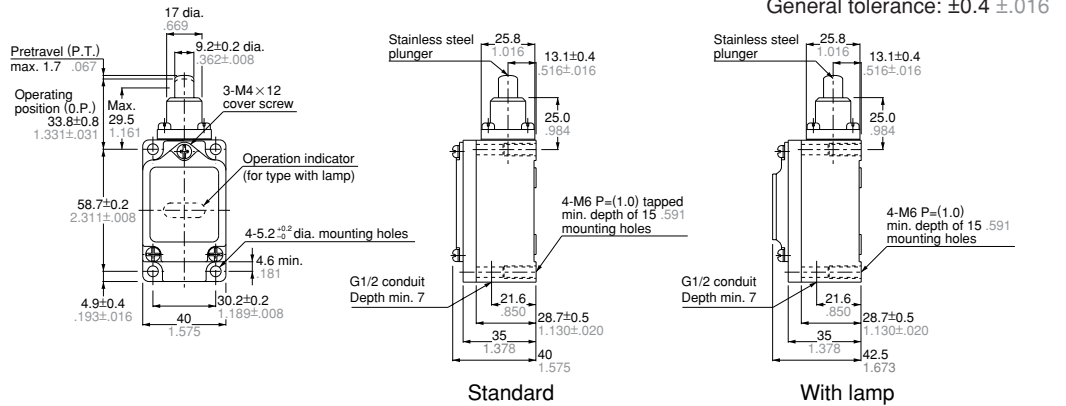

• Roller plunger  
Standard type



AZ5102

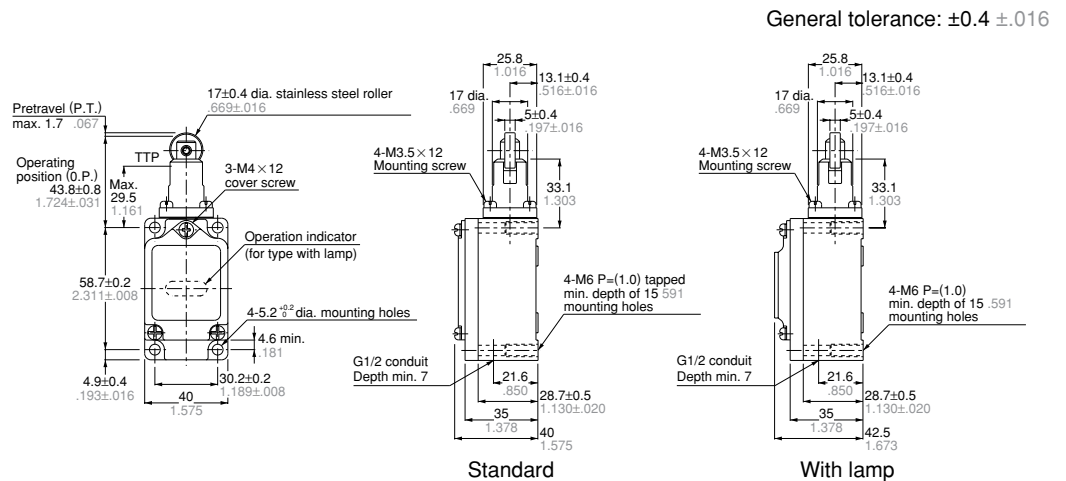

• Roller arm  
Standard type



AZ5104

AZ5124 (O.T. amplified)  
Weight: 250g

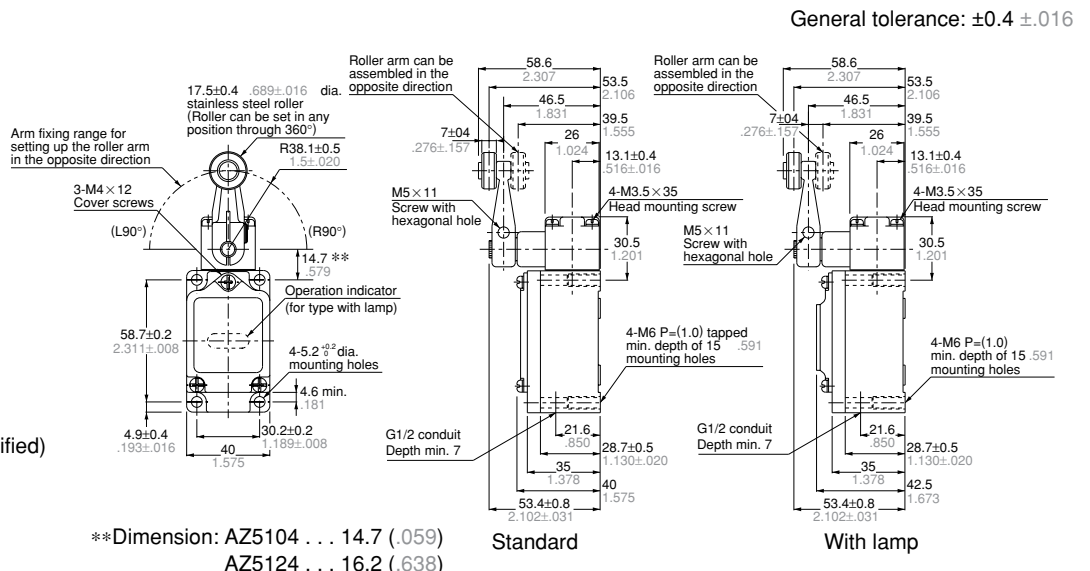

\*\*Dimension: AZ5104 ... 14.7 (.059)  
AZ5124 ... 16.2 (.638)

# AZ5

## • Yoke Standard type



AZ5105

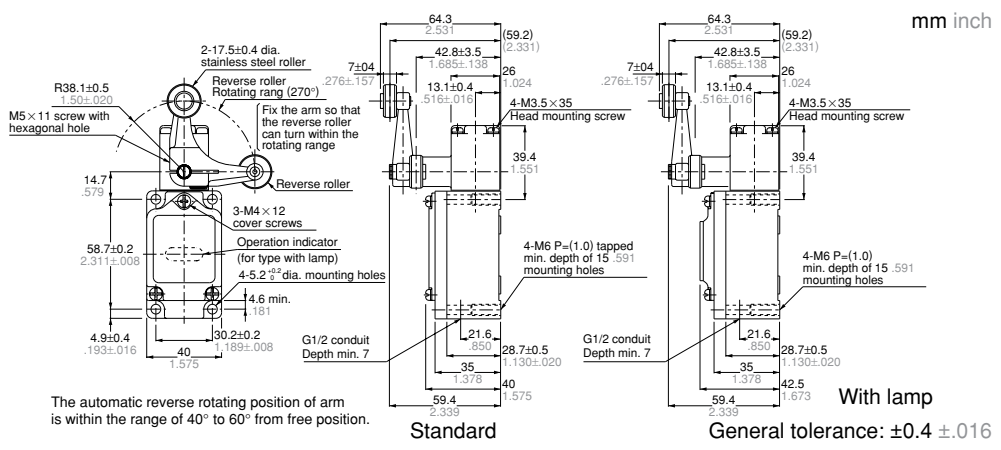

The automatic reverse rotating position of arm is within the range of 40° to 60° from free position.

## • Flexible rod Standard type



AZ5106

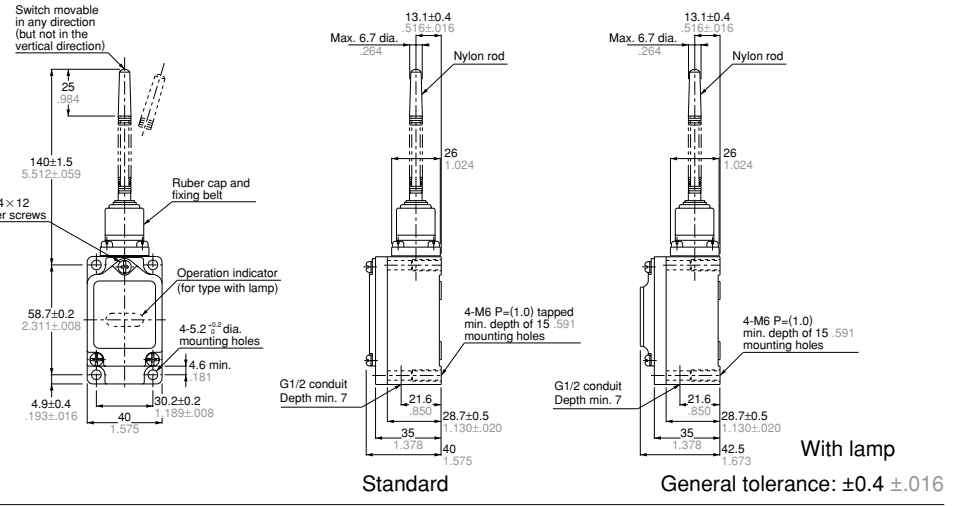

## • Adjustable rod Standard type



AZ5107  
AZ5127  
(O.T. amplified)  
Weight: 252g

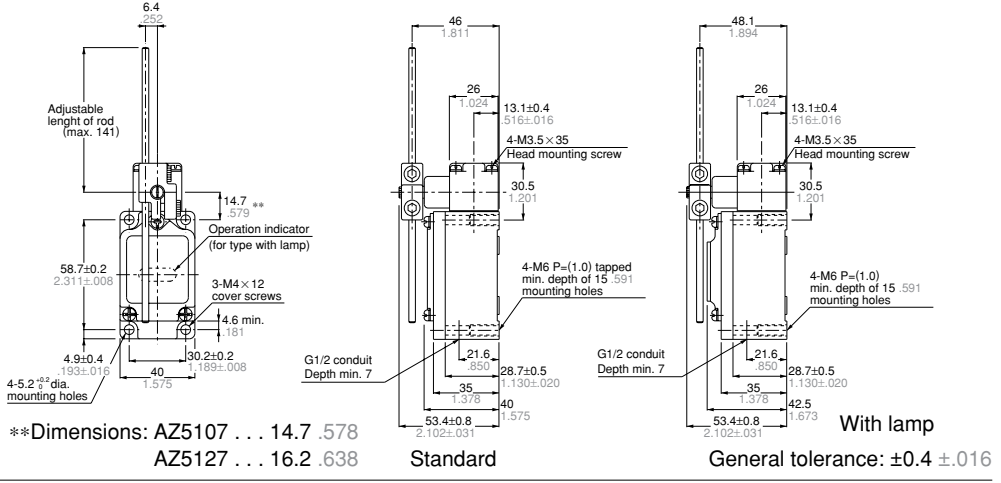

\*\*Dimensions: AZ5107 ... 14.7 .578  
AZ5127 ... 16.2 .638

## • Adjustable roller arm Standard type



AZ5108  
AZ5128 (O.T. amplified)

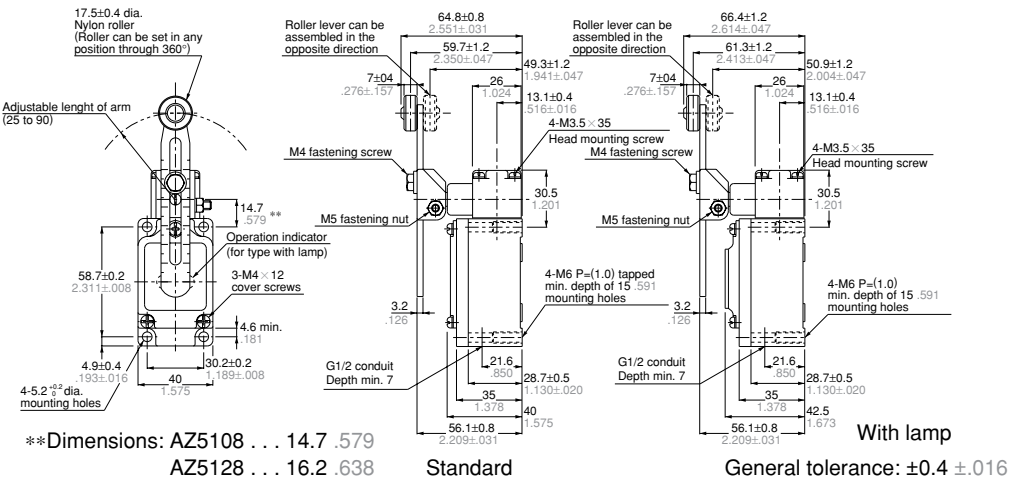

\*\*Dimensions: AZ5108 ... 14.7 .579  
AZ5128 ... 16.2 .638

### Arm Setting Position

The roller arm of the arm types (AZ5104, AZ5105, AZ5107, AZ5108, AZ5124, AZ5127, AZ5128 and each type with lamp) can be set in any position through 360°.

Loosen the arm fastening hex. bolt, reposition the arm, and retighten the hex. bolt.

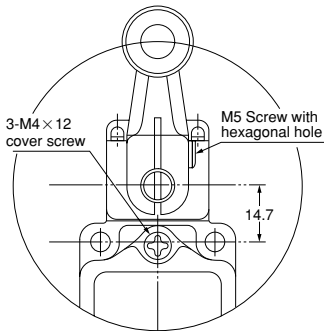

### Head Block Direction

1. The head block of the arm types (AZ5104, AZ5105, AZ5107, AZ5108, AZ5124, AZ5127, AZ5128 and each type with lamp) can be set in any of four directions.

Loosen four screws on the head, and set the head in a desired direction.

At this time, change the operation plunger orientation at the same time.

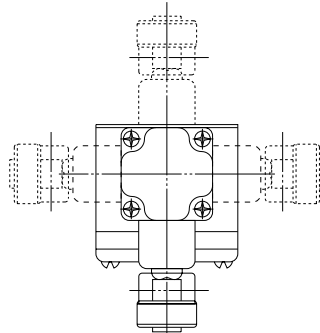

2. The head block of the roller plunger type (AZ5102) can be set in two directions. Remove the four bushing screws, and set the head in a desired direction.

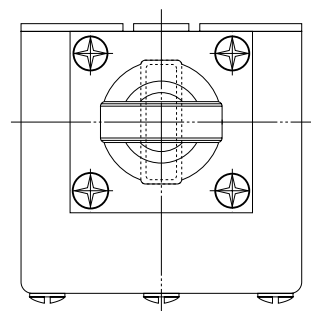

### Operating Direction

1) Both direction

The arm of AZ5104, AZ5107, AZ5108 and each type with lamp can be set to operate electrically either to both directions or only to the right or the left.

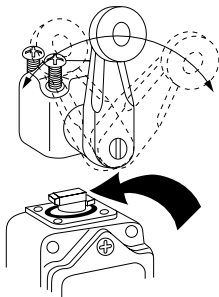

2) Clockwise

Remove the head block, turn the notch of a operating plunger counterclockwise in 90°, and retighten the head block.

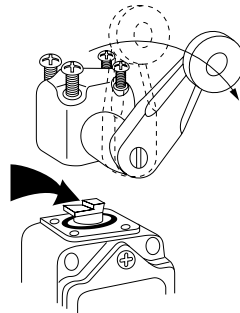

3) Counterclockwise

Remove the head block, turn the notch of a operating plunger clockwise in 90°, and retighten the head block.

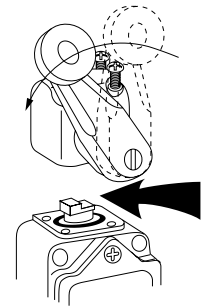

\*O.T. amplified types "AZ5124, AZ5127 and AZ5128": only both directions

### Roller Direction

The roller of the arm types (AZ5104, AZ5108, AZ5124, AZ5128 and each type with lamp) can be mounted on the front and rear side. To set the roller on the rear side, remove the arm fastening hex. nut, and reinsert the arm so as to face the roller in the rear direction. Then, retighten the hex. nut.

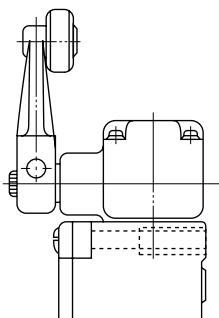

### REVERSE MOUNTING

When a switch is mounted from the reverse side of a panel, use the mounting holes in the body.

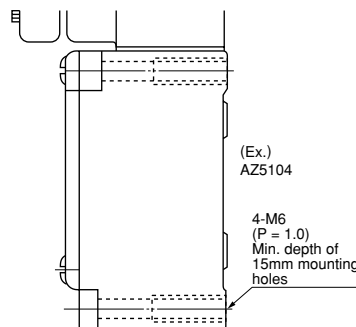

# LAMP LIGHTING CIRCUIT

## 1. Spring type

1) When connecting load to N.O. side:  
When the switch is at free position, the lamp is lit, and when the switch operates, the lamp turns off.  
(Use the lamp holder in the same condition as when it was at the time of shipment.)

2) When connecting load to N.C. side:  
When the switch is at free position, the lamp turns off, and when the switch operates, the lamp is lit.  
(Use the lamp holder, changing it direction by 180°.)

3) When connecting loads to both N.O. and N.C. sides:  
Same as in 1).  
(Use the lamp holder in the same condition as when it was at the time of shipment. In this case, it is impossible to use it, changing its direction by 180°.)

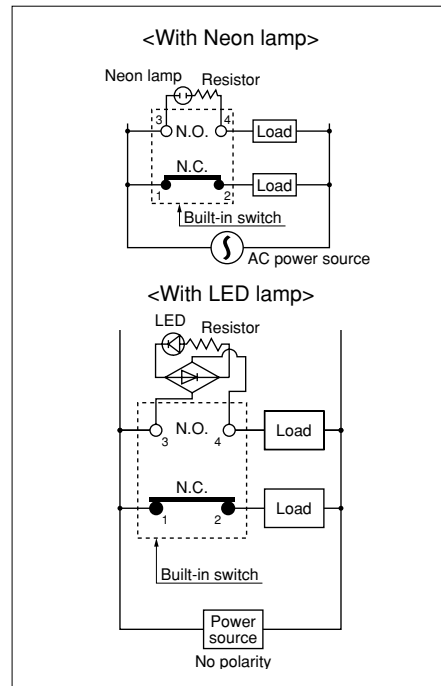
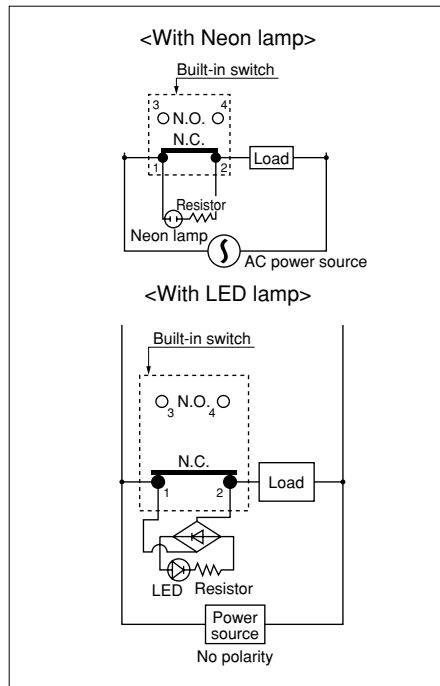
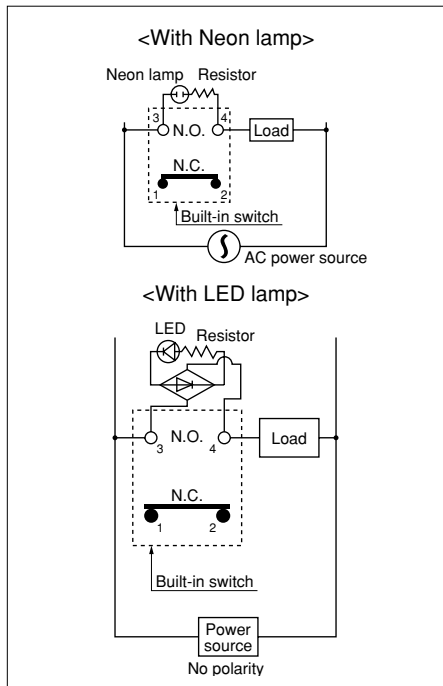

## 2. Lead wire type (only for types with LED)

1) When giving indication on N.O. side and N.C. side:  
Operation is same as that in the case of the spring type. However, when load is connected to both N.O. side and N.C. side, indication can be given on both N.C. side and N.O. side.

2) When the indication circuit is connected with load in parallel:  
Load performs the same operation as the indication circuit does.  
(When load operates, the lamp is lit, and when load is turned off, the lamp goes out.)

- More loads than for one circuit cannot be controlled.
- There is no leakage current.

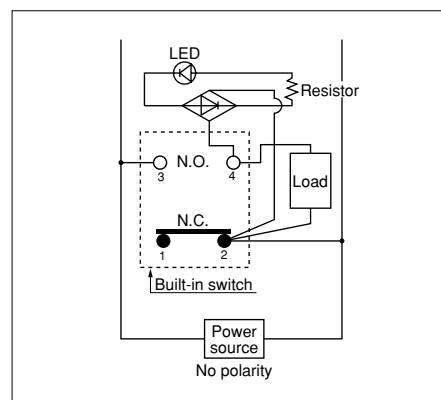

## CAUTIONS

1. Please use the lamp connection circuit within the lamp ratings.
2. Nylon is used for a lamp cover. Avoid using in the atmospheres containing acid substance.
3. The lamp cover cannot be installed on previous limit switches.
4. Remove the lamp holder with a ⊖ driver, and insert it in the opposite direction.



## CAUTIONS

1) This model uses silver terminals. Therefore, if used at relatively low frequencies for long periods of time, or if used with very small loads, the oxidation that forms on the contact surfaces will not wear away and eventually cause improper contact. For such applications, use limit switches with gold/metal contacts (e.g. VL limit switches) or ones meant for small loads (e.g. HL limit switches).

2) This switch is not designed for underwater use. Do not use the unit underwater.

3) Do not use the switch where it may come in direct contact with organic solvents, strong acids, strong alkaline liquids or steam, or in atmospheres containing flammable or corrosive gases.

4) To improve reliability during actual use, it is recommended that the operation be checked under installation conditions.

5) If OT is too big, the life of limit switch will be shortened switching friction. Use it with enough margin of OT. 70% of OT standard value will be good for use.

6) Do not use the switch in a silicon atmosphere. Case should be taken where organic silicon rubber, adhesive, sealing material, oil, grease or lead wire generates silicon.

7) To protect against entry of foreign matter from the outside, we recommend sealing as much as possible using conduit connectors.







8) Avoid use in excessively dusty environments where actuator operation would be hindered.

9) When used outdoors (in places where there is exposure to direct sunlight or rain such as in multistory car parks) or in environments where ozone is generated, the influence of these environments may cause deterioration of the rubber material. Please consult us if you intend to use a switch in environments such as these.

10) Do not store in places where organic gas might be generated or in places of high dust content or high humidity.





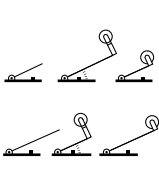
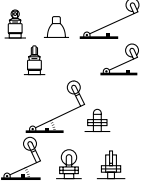
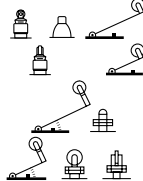
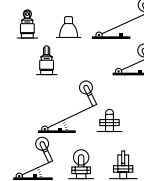
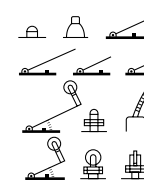
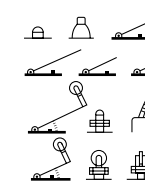







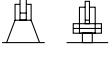





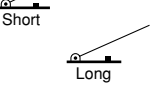
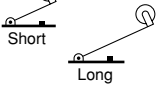
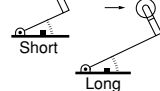



# SELECTOR CHART

Classification		Subminiature size	Compact size																																																
Product name		SL (AZ3) Micro Limit Switches	HL (AZH) Limit Switches (Die cast case)	HL (AZH) Limit Switches (Die cast case)	HL (AZH) Limit Switches (Plastic case)	ML (AZ7) Limit Switches (standard)	ML (AZ7) Limit Switches (Epoxy-Sealed terminal type)																																												
Appearance																																																			
Head code		AZ3	AZH20 22	AZH23	AZH10 12	AZ7	AZ7																																												
Feature		<ul style="list-style-type: none"> <li>A limit switch with high-density mounting that improves stroke capacity through an O.T. absorption-type spring.</li> <li>LED lamp type also available.</li> </ul>	<ul style="list-style-type: none"> <li>High sealability that satisfies IEC IP67.</li> <li>Wiring is screw-terminal type.</li> <li>Bifurcated type also available.</li> </ul>	<ul style="list-style-type: none"> <li>High sealability that satisfies IEC IP67.</li> <li>Less wiring, less installation connector type.</li> <li>LED lamp type also available.</li> </ul>	<ul style="list-style-type: none"> <li>Bifurcated type available.</li> <li>Perfect for applications that prioritize economy.</li> </ul>	<ul style="list-style-type: none"> <li>Switches installed with both economical and compact Z-basic microswitches and limit switch protective construction.</li> <li>Coil spring system provides long life.</li> </ul>	<ul style="list-style-type: none"> <li>An ML compact limit switch with an epoxy-sealed case that completely encloses the terminal.</li> </ul>																																												
With lamps	Dust-proof type	IP60	<input type="radio"/>	<input type="radio"/>	<input type="radio"/>	<input type="radio"/>	<input type="radio"/>																																												
	Abrasion-proof type	IP64	<input type="radio"/>	<input type="radio"/>	<input type="radio"/>	<input type="radio"/>	<input type="radio"/>																																												
	Surge-proof type	IP65	<input type="radio"/>	<input type="radio"/>	<input type="radio"/>	<input type="radio"/>	<input type="radio"/>																																												
	Corrosion-proof type	IP67	<input type="radio"/>	<input type="radio"/>	<input type="radio"/>	<input type="radio"/>	<input type="radio"/>																																												
	Oil-resistant type	—	<input type="radio"/>	<input type="radio"/>	<input type="radio"/>	<input type="radio"/>	<input type="radio"/>																																												
	Neon	—	<input type="radio"/>	<input type="radio"/>	<input type="radio"/>	<input type="radio"/>	<input type="radio"/>																																												
LED	—	<input type="radio"/>	<input type="radio"/>	<input type="radio"/>	<input type="radio"/>	<input type="radio"/>																																													
Ratings (load resistance)		4A250V AC 4A125V AC 4A30V DC 0.1A 125V DC	<table border="0"> <tr> <td>[Standard type]</td> <td>[Bifurcated type]</td> </tr> <tr> <td>5A125V AC</td> <td>0.1A125V AC</td> </tr> <tr> <td>5A250V AC</td> <td>0.1A8V DC</td> </tr> <tr> <td>5A8V DC</td> <td>0.1A14V DC</td> </tr> <tr> <td>5A14V DC</td> <td>0.1A30V DC</td> </tr> <tr> <td>5A30V DC</td> <td></td> </tr> <tr> <td>0.5A125V DC</td> <td></td> </tr> <tr> <td>0.25A250V DC</td> <td></td> </tr> </table>	[Standard type]	[Bifurcated type]	5A125V AC	0.1A125V AC	5A250V AC	0.1A8V DC	5A8V DC	0.1A14V DC	5A14V DC	0.1A30V DC	5A30V DC		0.5A125V DC		0.25A250V DC		<table border="0"> <tr> <td colspan="2">[Bifurcated type]</td> </tr> <tr> <td>without LEDlamps</td> <td>with LEDlamps</td> </tr> <tr> <td>0.1A125V AC</td> <td>0.1A24V AC</td> </tr> <tr> <td>0.1A8V DC</td> <td></td> </tr> <tr> <td>0.1A14V DC</td> <td></td> </tr> <tr> <td>0.1A30V DC</td> <td></td> </tr> </table>	[Bifurcated type]		without LEDlamps	with LEDlamps	0.1A125V AC	0.1A24V AC	0.1A8V DC		0.1A14V DC		0.1A30V DC		<table border="0"> <tr> <td>[Standard type]</td> <td>[Bifurcated type]</td> </tr> <tr> <td>5A125V AC</td> <td>0.1A125V AC</td> </tr> <tr> <td>5A250V AC</td> <td>0.1A8V DC</td> </tr> <tr> <td>5A8V DC</td> <td>0.1A14V DC</td> </tr> <tr> <td>5A14V DC</td> <td>0.1A30V DC</td> </tr> <tr> <td>5A30V DC</td> <td></td> </tr> <tr> <td>0.5A125V DC</td> <td></td> </tr> <tr> <td>0.25A250V DC</td> <td></td> </tr> </table>	[Standard type]	[Bifurcated type]	5A125V AC	0.1A125V AC	5A250V AC	0.1A8V DC	5A8V DC	0.1A14V DC	5A14V DC	0.1A30V DC	5A30V DC		0.5A125V DC		0.25A250V DC		10A250V AC 10A125V AC 0.4A115V DC	10A250V AC 10A125V AC 0.4A115V DC
[Standard type]	[Bifurcated type]																																																		
5A125V AC	0.1A125V AC																																																		
5A250V AC	0.1A8V DC																																																		
5A8V DC	0.1A14V DC																																																		
5A14V DC	0.1A30V DC																																																		
5A30V DC																																																			
0.5A125V DC																																																			
0.25A250V DC																																																			
[Bifurcated type]																																																			
without LEDlamps	with LEDlamps																																																		
0.1A125V AC	0.1A24V AC																																																		
0.1A8V DC																																																			
0.1A14V DC																																																			
0.1A30V DC																																																			
[Standard type]	[Bifurcated type]																																																		
5A125V AC	0.1A125V AC																																																		
5A250V AC	0.1A8V DC																																																		
5A8V DC	0.1A14V DC																																																		
5A14V DC	0.1A30V DC																																																		
5A30V DC																																																			
0.5A125V DC																																																			
0.25A250V DC																																																			
Life (Min. ope.)	Mechanical	10 <sup>7</sup>	10 <sup>7</sup>	10 <sup>7</sup>	10 <sup>7</sup>	10 <sup>7</sup>	10 <sup>7</sup>																																												
	Electrical	10 <sup>5</sup>	5x10 <sup>5</sup>	5x10 <sup>5</sup>	5x10 <sup>5</sup>	2x10 <sup>5</sup>	2x10 <sup>5</sup>																																												
Operating force (max.) (hinge lever type)		0.98N {100gf} 1.96N {200gf} (short lever type) 2.94N {300gf}	2.45N {250gf} 3.92N {400gf} 11.8N {1,200gf} (Plunger type)	2.45N {250gf} 3.92N {400gf} 11.8N {1,200gf} (Plunger type)	2.45N {250gf} 3.92N {400gf}	1.47N {150gf}, 1.77N {180gf}, 1.96N {200gf}, 2.16N {220gf}, 2.35N {240gf}, 2.75N {280gf}, 5.88N {600gf} max.	1.47N {150gf}, 1.77N {180gf}, 1.96N {200gf}, 2.16N {220gf}, 2.35N {240gf}, 2.75N {280gf}, 5.88N {600gf} max.																																												
Available actuators																																																			
Terminals		<ul style="list-style-type: none"> <li>Rubber cover (Solder and quick connect (#110) terminal)</li> <li>Socket with cord</li> </ul>	Screw terminal	Connector terminal	Screw terminal	Screw terminal	Vinyl cabtire cable (1m 3.281ft)																																												
Wiring		Cabtire code	Cabtire code	Cabtire code	Cabtire code	Cabtire cable	Cabtire cable																																												
Mounting pitch (Applicable screw)		Cross-angled wiring 28 × 14mm 1.102 × .551inch (M4 screw)	33mm 1.299inch (M4 screw)	33mm 1.299inch (M4 screw)	33mm 1.299inch (M4 screw)	25.4mm 1.000inch (M4 screw)	25.4mm 1.000inch (M4 screw)																																												
Available standards		UL, CSA	UL, CSA, TÜV, CE	UL, CSA, TÜV, CE	UL, CSA, TÜV, CE	UL, C-UL, TÜV, CE	—																																												
Page		P.13	P.18	P.18	P.18	P.33	P.33																																												

Note: Excludes limit switch replacement parts

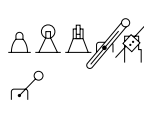
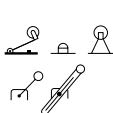
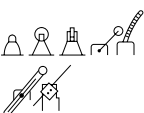
## Actuators

Push plunger 	Roller plunger 	Cross-roller plunger 	Roller arm 	Adjustable roller arm 	Adjustable rod 	Fork 
Spring wire 	Flexible rod 	Hinge lever 	Roller lever 	One-way roller lever 	Roller lever 	





Classification		Subminiature size vertical type	Compact size vertical type		Vertical type	Touch type	Door switch			
Product name		QL (AZ4) Micro Limit Switches	DL (AZD1) Mini Limit Switches	VL (AZ8) Mini Limit Switches	AZ5 Limit Switches	VL-T Mini Touch Limit Switches	Compact Magnelimit	Magnelimit		
Appearance										
Head code		AZ4	AZD1	AZ8	AZ5	AZ84	AZC3	AZC1		
Feature		<ul style="list-style-type: none"> <li>A subminiature, highly accurate limit switch with built-in environment-proof functions.</li> <li>Cord extraction can be changed in four directions, due to the dedicated L socket.</li> <li>LED lamp can also be attached.</li> </ul>	<ul style="list-style-type: none"> <li>Excellent safety even if the contact point is welded, due to the forced contact opening mechanism.</li> <li>Block mount system makes parts replacement easy.</li> <li>Conforms to DIN standards.</li> </ul>	<ul style="list-style-type: none"> <li>In addition to the characteristics of stand mounted limit switches, is compact, easily installable, highly reliable, lightweight, and economical.</li> </ul>	<ul style="list-style-type: none"> <li>Built-in dedicated circuit breaker (1 Form A 1 Form B).</li> <li>Different types of actuator available.</li> </ul>	<ul style="list-style-type: none"> <li>Operate just by touching lightly.</li> <li>Comes with sensitivity adjustment function and indicates operations.</li> <li>VL type touch limit switch</li> </ul>	<ul style="list-style-type: none"> <li>Secured by magnet</li> <li>Built-in switch detection</li> <li>Dual-role switch in one unit.</li> <li>Safe design prevents operator making errors.</li> </ul>	<ul style="list-style-type: none"> <li>Secured by magnet</li> <li>Built-in switch detection</li> <li>Dual-role switch in one unit.</li> <li>Construction possible with 100V AC power.</li> </ul>		
With lamps	Protective construction	Dust-proof type	IP60	<input type="checkbox"/>	<input type="checkbox"/>	<input type="checkbox"/>	<input type="checkbox"/>	<input type="checkbox"/>	<input type="checkbox"/>	
		Abrasion-proof type	IP64	<input type="checkbox"/>	<input type="checkbox"/>	<input type="checkbox"/>	<input type="checkbox"/>	<input type="checkbox"/>	<input type="checkbox"/>	
		Surge-proof type	IP65	<input type="checkbox"/>	<input type="checkbox"/>	<input type="checkbox"/>	<input type="checkbox"/>	<input type="checkbox"/>	<input type="checkbox"/>	
		Corrosion-proof type	IP67	<input type="checkbox"/>	<input type="checkbox"/>	<input type="checkbox"/>	<input type="checkbox"/>	<input type="checkbox"/>	<input type="checkbox"/>	
		Oil-resistant type	—	<input type="checkbox"/>	<input type="checkbox"/>	<input type="checkbox"/>	<input type="checkbox"/>	<input type="checkbox"/>	<input type="checkbox"/>	
		Neon	—	<input type="checkbox"/>	<input type="checkbox"/>	<input type="checkbox"/>	<input type="checkbox"/>	<input type="checkbox"/>	<input type="checkbox"/>	
LED	—	<input type="checkbox"/>	<input type="checkbox"/>	<input type="checkbox"/>	<input type="checkbox"/>	<input type="checkbox"/>	<input type="checkbox"/>			
Ratings (load resistance)		5A250V AC	6A250V AC 6A380V AC 5A24V DC	[Standard type] 5A250V AC 5A125V AC 0.4A125V DC	[With lamp type] (Neon lamp type) 5A 240V AC 5A 125V AC [LED lamp type] 3A 24V DC	[Standard type] 10A125V AC 6A250V AC 2A500V AC 0.8A125V DC	[With lamp type] (Neon lamp type) 10A 125V AC 6A 240V AC [LED lamp type] 6A 24V DC	Input voltage 12-24V DC Output current 150mA	<sup>2)</sup> 5A (2A) 125V AC 5A (2A) 250V AC 5A (2A) 30VDC	5A 125V AC 5A 250V AC 5A 30VDC
Life (Min. op.e.)	Mechanical	10 <sup>7</sup>	10 <sup>7</sup>	10 <sup>7</sup>	10 <sup>7</sup>	10 <sup>7</sup>	10 <sup>7</sup>	10 <sup>5</sup>	10 <sup>5</sup>	
	Electrical	3x10 <sup>5</sup>	1.5x10 <sup>5</sup>	3x10 <sup>5</sup>	5x10 <sup>5</sup>	—	—	5x10 <sup>4</sup>	5x10 <sup>4</sup>	
Operating force (max.) (hinge lever type)		6.86N {700gf} (Plunger type) 1.11N {113gf}, 4.41N {450gf} (Arm type)	6.37N {650gf} 4.90N {500gf} 3.29N {400gf}	0.88N {90gf}, 5.88N {600gf}, 8.83N {900gf}, 19.16N {2,000gf}	1.39N {142gf} 26.67N {2,720gf}	—	—	—	3.43N {350gf}	
Available actuators										
Terminals		<ul style="list-style-type: none"> <li>L socket (Solder and quick connect (#110) terminal)</li> <li>Socket with code</li> </ul>	Screw terminal (Conduit connectors: PF: 1/2, PG: 13.5 types)	Screw terminal	Screw terminal	Screw terminal	Tab #110 terminal Lead wire	Screw terminal		
Wiring		Cabtire code	Cabtire code	Cabtire cord Cap tire cable	Cabtire cable (wiring type)	Cabtire cord Cabtire cable	Cabtire cord	Cabtire cord		
Mounting pitch (Applicable screw)		14 × 28mm .551 × 1.102inch (M4 screws)	22 × (47mm) .866 × 1.850inch (M4 screws)	21 × 56mm .827 × 2.205inch (M4 screws)	30.2 × 58.7mm 1.189 × 2.311inch (M5 screws)	21 × 56mm 827 × 2.205inch (M4 screws)	30mm 1.181inch (M3)	52mm 2.047inch (M4)		
Available standards		UL, CSA	UL, C-UL, TÜV, CE	UL, C-UL, TÜV, CE	UL	—	UL, C-UL	UL, C-UL, CE		
Page		P.38	P.44	P.52	P.61	P.68	P.72	P.74		

Notes: 1) Excludes exposed part of terminals, externally mounted components, and magnet catches.  
2) Figures in parentheses ( ) indicate rated current of water-resistant type.

## Other listed products

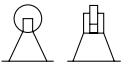
Product name	PS Hall Sensors
Appearance	 AN9 Detector distance 2.5mm .098inch
Feature	<ul style="list-style-type: none"> <li>Magnetic detector type subminiature sensor</li> <li>Perfect for slide table limiting</li> <li>Economical price with operating display lamp attached.</li> </ul>
Page	P.76

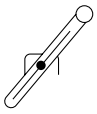
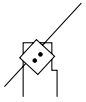
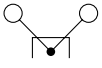
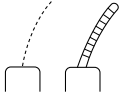
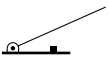
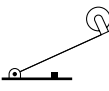
# ACTUATOR SELECTION

Type	Classification	Pretravel (P.T.)	Overtravel (O.T.)	Operating force (O.F.)	Accuracy	Vibration shock	Characteristics
	Push plunger type	Small	Medium	Large	Excellent	Excellent	High-level accuracy gives firm detection for position fixing, etc., by using perpendicular movement.
	Roller plunger type (includes cross roller plunger)	Small	Medium	Large	Excellent	Excellent	Operating range can be widened by mounting accessory actuators like cams, dogs, cylinders, etc. High-level detection for position fixing.
	Roller arm type	Small to large	Large	Medium	Good to excellent	Excellent	The stroke in the direction of revolution is large at between 45° and 90° and the lever angle can be set at will to within 360° for easy use. Wide angle type (large O.T.) available. Can be used for wide-range position fixing.
	Adjustable roller arm type	Small to large	Large	Medium	Good to excellent	Good	Lever length can be altered to allow rough operation detection using the roller lever characteristics.
	Adjustable rod type	Large	Large	Medium	Good	Good	Wide range of operations, and convenient for uneven mountings. Lightest operation among the revolving operation type of limit switches. Rod length is adjustable, and bending is also easy.
	Fork	Large	Medium	Medium	Good	Excellent	If operated up to 55° position, revolves automatically to retain 90° position. Two dog operation enables recovery operation through single dog, or for anything that has caused the roller position to slip.
	Spring wire and flexible rod	Medium	Large	Small	Possible	Possible	Excluding the thread direction, direction can be adjusted up to 360°. Operating power is the lowest of the limit switches, and is effective in detecting when direction and conditions are uneven. In order to absorb the movements after operation in the actuator part, work slippage tolerances are also large.
	Hinge lever type	Large	Medium	Small	Possible	Possible	Using a low speed, low torque cam, the lever can assume various shapes suited to the operation. The lever is very sturdy.
	Roller lever type	Large	Medium	Small	Possible	Possible	Suited to high speed cams through the attachment of a hinge roller lever.
	One way roller lever type	Medium	Medium	Medium	Possible	Possible	Operation is possible with both hinge lever type and one way operation, but the roller will break if operated in the opposite direction, rendering the unit inoperable. Can be used to prevent opposite direction movement.
	Roller lever type	Medium	Medium	Medium	Possible	Possible	The roller position can be changed.

# TECHNICAL INFORMATION

## Standard glossary

- Fixed rating values**  
 The values that guarantee the standards for the limit switch characteristics and functions. For example, the rated current and rated voltage, which are preset conditions (load type, current, voltage, frequency, etc.)
- Operating object**  
 The mechanism and mountings that operate the limit switch actuator. Used for mechanical operators such as cams and dogs.
- Detective object**  
 The unit other than mechanical mountings that operate the limit switch. Products, parts, jigs, etc.
- Reaction spring (movable spring)**  
 The mechanical part that switches the limit switch contact is called either the reaction spring or the moveable spring.
- Contact**  
 When the counter-spring revolves, power is switched on and off through the contact between metal parts
- Contact gap**  
 The effective clearance between the fixed contact and the moveable contact. Also called breaking distance.
- Contact arrangement**  
 The construction of the electrical input/output circuit depending on use. For example, the following two applications:

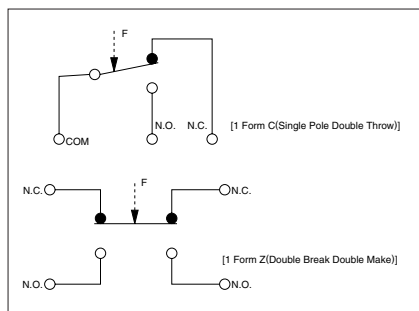

- Contact type**  
 Used in opposition to a semiconductor switch that has switching characteristics. Fulfills switch functions through a mechanical ON/OFF contact.
- Terminal mold**  
 After wiring, the connecting part is molding by epoxy resin for water-proof, oil-resistant and dust-proof capabilities.

## CONSTRUCTION

- Actuator**  
 This part directly detects movement of the dog, cam, and so forth in the operating unit, and transmits external force to the changeover mechanism, thereby engaging the moveable contact and operating the switch.
- Headblock**  
 An independent part of the actuator mechanism of the Limit Switch.
- Wiring vent (cord vent)**  
 The seal on the wiring at the mouth of the wiring vent. Also called the conduit vent for the screw hole used in the wiring.
- Terminals**  
 The part of the wiring work in the wiring that forms the circuit for electrical input and output.

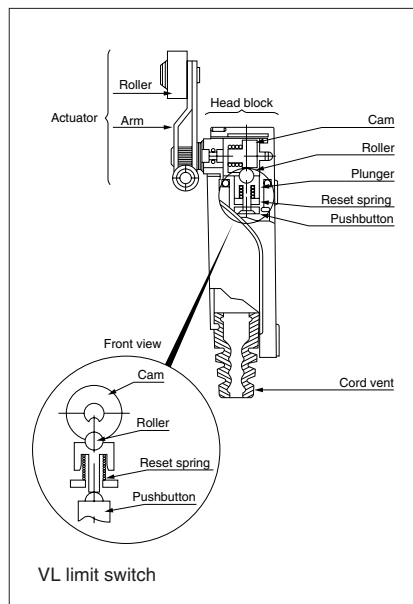

## OPERATING CHARACTERISTICS

- Operating Force (O.F.)**  
 The force required to cause contact snap-action. It is expressed in terms of force applied to the actuator.
- Release Force (R.F.)**  
 The force to be applied to the actuator, at the moment contact snaps back from the operated position to unoperated position.
- Pretravel (P.T.)**  
 Distance of the actuator movement from free position to operating position.
- Overtravel (O.T.)**  
 The distance which the actuator is permitted to travel after actuation without any damage to the switching mechanism.
- Total Travel (T.T.)**  
 The distance which the actuator is permitted to travel from free position without any damage to the switching mechanism.
- Movement Differential (M.D.)**  
 The distance from operating to release position of the actuator.
- Operating Position (O.P.)**  
 The position of the actuator when the traveling contact snaps to the fixed contact.
- Release Position (R.P.)**  
 The position of the actuator when the traveling contact snaps back from the operating position to its original position.
- Free Position (F.P.)**  
 Position of the actuator when no force is applied to it.

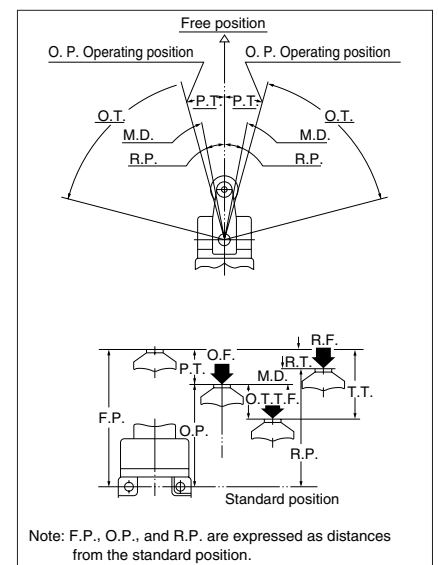

# TECHNICAL INFORMATION

## ■ Glossary relating to the EN60947-5-1

- **EN60947-5-1**  
EN standard same as IEC947-5-1
- **Utilization categories**  
The following examples express the classification of switches by category of use.

Current type	Category	Contents
AC	AC-15	Controls electromagnetic loads in excess of 72VA (Volt Amperes.)
DC	DC-12	Controls resistance loads and semiconductor loads.

- **Rated operational voltage (Ue)**  
The maximum rated voltage for switch operation. This must never exceed the maximum ratings insulation voltage (Ui).
- **Rated operational current (Ie)**  
The maximum rated current for switch operation.
- **Rated insulation voltage (Ui)**  
The maximum rated current value which guards the switch's insulation functions, forming the parameters for the resistance values and the mounting distance.

- **Rated impulse withstand voltage (Uimp)**  
The peak impulse current value which enables the switch to resist without insulation breakdown.
- **Rated enclosed thermal current (Ithe)**  
The current value that enables current to flow without exceeding the specified maximum temperature in the recharging contact switch. If the pins are made of brass, the maximum temperature limit is 65°C 149°F.
- **Conditional short circuit current**  
The current the switch can resist until the short circuit protection device is activated.
- **Short circuit protection device**  
A device that protects the switch from short circuits through a circuit break (breakers, fuses, etc.)
- **Switching overvoltage**  
The surge momentarily generated when a circuit is closed. Must be lower than the Uimp value.

- **Pollution degree**  
Expresses in levels the environment in which the switch is used. The four levels are shown below. Limit switches come under contamination level 3.

Pollution degree	Contents
1	No contamination or, even if contamination is present, only non-conducting contamination is generated.
2	Normally, only non-conducting contamination is generated, but there remains the possibility of temporary conducting contamination when the circuit is formed.
3	Conducting contamination is generated, or else dry non-conducting contamination is generated by circuits which can be anticipated.
4	Permanent conducting contamination is generated by dust, rain, snow, and other conductors.

# PROTECTIVE CONSTRUCTION

## Protective construction

Expresses the degree of protective construction that guards the level of functionality of the switch against ingress of solid objects, water, and oil. The standards are IEC529 (IEC: International Electrotechnical Commission) standards. IEC standards determine the level of protection against both water and solid objects, but not against oil.

### Protection against both water and solid objects

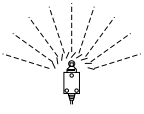
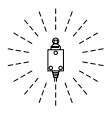
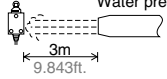
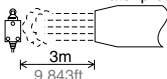
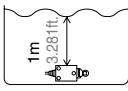
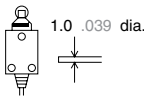
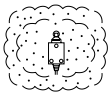
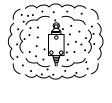
Level	Protection level	Protection level and test methods
0	—	No particular protection
3	<b>Rain-proof</b>	Protection against rain fall  No damage incurred when sprayed with water continuously for 10 minutes at angles of up to 60° from the perpendicular.
4	<b>Foam-proof</b>	Protection against flying foam  No damage incurred when sprayed with water continuously for 10 minutes at angles of up to 180° from the perpendicular across a wide area.
5	<b>Spray-proof</b>	Protection against spray Nozzle radius 6.3mm .248inch Water pressure 30kP  No damage incurred when sprayed with a jet of water for 3 minutes from all directions, as per the diagram on the left.
6	<b>Water proof</b>	Protection against waves Nozzle radius 12.5mm .492inch Water pressure 100kP  Water does not invade the interior when sprayed with a jet of water for 3 minutes from all directions, as per the diagram on the left.
7	<b>Corrosion-proof</b>	Protection against corrosion while immersed in water  Water does not invade the interior during immersion for 30 minutes at a depth of 1m 3.281ft..
Level	Protection level	Protection level and test methods
4	—	Protection against solid objects exceeding 1mm .039inch in size.  A hard wire 1mm dia. .039 inch dia. across cannot penetrate the inside.
5	—	Protection against dust  The unit is left for 8 hours in an atmosphere in which 2kg of talcum powder per 1m³ is floating. No damage incurred from talcum powder penetrating the inside.
6	<b>Dust-proof</b>	Protection against dust (dust does not penetrate)  The unit is left for 8 hours in an atmosphere in which 2kg of talcum powder per 1m³ is floating. The talcum powder does not penetrate the inside.

- Note:**
1. All of the tests cited above were conducted with the cord vent (conduit vent) tightly shut.
  2. The above protective constructions are based on IEC standard but major differences may arise due to length of use and operating environment. This should be thoroughly discussed and verified.
  3. When the corrosion-proof model is immersed in water for 30 minutes or more, verify that no water has penetrated the inside before use.

# CAUTIONS FOR USE

## DESIGN OF OPERATING DOG AND OPERATING SPEED

Pay attention to the following points when designing the dog for limit switch operation.

1. Make the dog faceplate as smooth as possible.
2. Adjust both the dog angle and the set arm angle as below, depending on the operating speed.
3. The depth (h) of the dog effects the lifespan of the limit switch. Therefore, set the depth to a maximum of 80% of the Total Travel (T.T.)
4. The relationship between the speed of the dog ( $V = m/s$ ) and the tip angle ( $\alpha$ ) is as follows:

1)  $V \leq 0.2m/s$

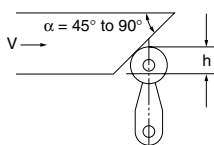

$\alpha$	$V_{max}$ (m/s)
45°	0.2
60°	0.1
60 to 90°	0.05

When  $V \leq 0.2m/s$ , set the arm to perpendicular and set the arm rise angle to between 45° and 90°. If the dog rise angle is reduced, the maximum tolerable speed is increased. As a rule,  $\alpha = 45^\circ$  is optimum.

2)  $V \leq 0.5m/s$

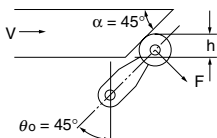

Because the arm jiggle is as a minimum at a comparative speed such as  $V \leq 0.5m/s$ , setting both the dog angle so that it travels perpendicularly and the arm angle to 45° is optimum.

3)  $0.5m/s < V \leq 2m/s$

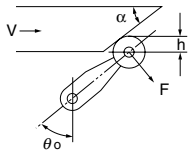

$\alpha$	$V_{max}$ (m/s)
40°	0.7
35°	0.9
30°	1.3
25°	2.0

The maximum tolerable speed can be extended by further reducing the dog rise angle from 45° when  $0.5m/s < V \leq 2m/s$ . It is necessary to set the arm so that the dog's cutting surfaces are always parallel ( $\theta_o = 90^\circ - \alpha$ )

4) Overriding the dog ( $V \leq 0.2m/s$ )

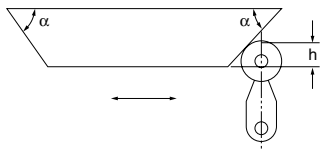

$\alpha$	$V_{max}$ (m/s)
45°	0.2
60°	0.1
60 to 90°	0.05

If overriding the dog, set the arm perpendicularly, so that  $\alpha = 45^\circ$ . If the dog angle is reduced, the tolerable speed is increased.

5) Roller plunger type

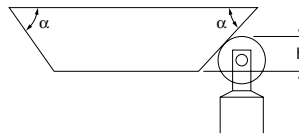

$\alpha$	$V_{max}$ (m/s)	h
20°	0.5	(0.5 to 0.7) T.T.
30°	0.25	(0.6 to 0.8) T.T.

Even if overriding the dog, set the forwards and rearwards motion exactly the same, and avoid any settings that make the actuator accelerate rapidly from the dog.

5. Operation speed

- 1) When the operation (acting and reverting) speed is exceedingly slow, switching of the contacts will become unstable and this could cause problems such as failure to make contact and welding. As a guide, the speed should be at least 1mm/s.
- 2) When the operation (acting and reverting) speed is exceedingly fast, be careful because the violent motion could cause breakage and with increased frequency, contact switching will not be able to keep up. As a guide, the switching frequency should be within 20 times per minute.

**PROTECTION CIRCUIT**

1. The ON/OFF circuit for the guidance load may suffer contact damage due to surges or inrushes when the power is turned either ON or OFF. Consequently, insertion of a protective circuit as per the following diagram is recommended, in order to protect the contacts.

Circuit	Caution for use
	(1) r must be a minimum of 10Ω; (2) When using AC power: ① Impossible when R impedance is large. ② Possible when c, r impedance is sufficiently small compared with R impedance.
	Can be used with both AC and DC as appropriate. $r \sim R$ $C: 0.1 \mu F$
	(1) Dedicated DC use. (2) AC is impossible
	Can be used with both AC and DC as appropriate.

2. Do not connect either irregular poles or power sources to a switch contact. Power connection examples (irregular pole connection)

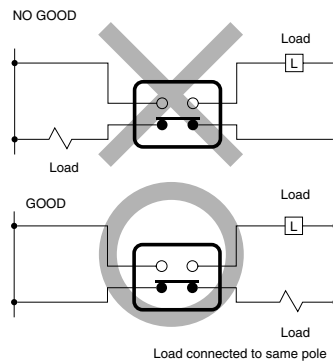

Example of unsuitable power connection (abnormal power connection)

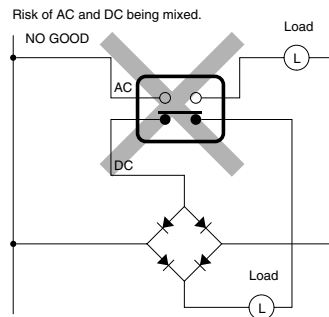

3. Avoid circuits where power may find a way between the contact points (as this may cause welding.)

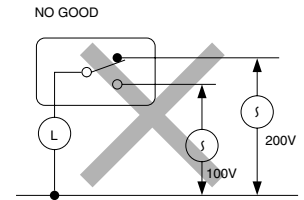

4. Using electronic switch circuits (low power, low current)  
 1) Bouncing and chattering are generated due to collision between the contacts when the limit switch is switching between them, and this sometimes causes such problems as white noises and error pulses in both the electronic circuit and the reverberation equipment.  
 2) If the generation of bouncing and chattering becomes a problem, it is necessary to consider installing a CR circuit or other absorption circuit given the circuit design.  
 3) This is particularly necessary when high contact reliability is needed, and is unsuitable for silver contact switches. Switches with gold contacts possess excellent performance.



# CAUTIONS FOR USE

---

## ■ CAUTIONS FOR USE

1) Do not attempt to physically alter any part of the switch itself, such as the actuator, or switch attachment vent, as this may cause alterations to both characteristics and performance, and damage the insulation.

2) Do not pour any lubricants such as oil or grease onto the moving parts of the actuator, as there is a possibility that this will cause a malfunction due to seepage into the inside, and impair the motion. Silicon-based grease in particular affects the contact points badly.

3) If the switches are not to be used for an extended period of time, their contact reliability may be reduced due to oxidation of the contact points.

Because accidents may result from the impaired conductivity, always implement a check beforehand.

4) Prolonged continuous use of the switch hastens deterioration of the parts (especially the seal rubber) and may cause a malfunction in the release. For this reason, always implement a check beforehand.

5) Usage in the vicinity of either the switch operating position (O.P.) or the release position (R.P.) results in unstable contacts. If using the NC contact point, set the actuator to return to the free position (F.P.) Also, is using the NO contact point, hold the ratings values down to 70 to 100% for the over-travel (O.T.)

6) If the actuator is forced beyond its total travel (T.T.), the internal mechanism may be damaged. Always use within the T.T.

7) Do not apply unreasonable force to the actuator, as this may result in damage and impaired movement.

8) The switch, if dropped, may break due to excessive vibration and impact. Therefore, please use extra caution when transporting and installing.

9) Condensation inside the switch may occur if there are rapid ambient temperature changes when the switch is in a high temperature and humidity.

Since this occurs easily during marine transport, be extra cautious of what the environment will be when shipping.

Condensation is the phenomenon in which water vapor condenses into switch-adhering water droplets when the temperature rapidly drops in a high-temperature, high-humidity atmosphere or when the switch is quickly moved from a low temperature location to a place of high temperature and high humidity. It is the cause of insulation deterioration and of rust.

10) Be careful of freezing in temperatures below 0°C. Freezing is the phenomenon in which moisture adhering to the switch from condensation or when in unusually high-humidity environments freezes onto the switch when the temperature drops below the freezing point. Please extra caution because freezing can lock moving parts, cause operational delays, or interfere with conductivity when there is ice between the contacts.

11) In low-temperature, low-humidity conditions, plastic becomes brittle and the rubber and grease harden, which may lead to malfunction.

12) Long term storage (including during transport) in high temperature or high humidity environments or where the atmosphere contains organic or sulfide gas, will cause sulfide or oxide membrane to form on the contact surfaces. This in turn will cause unstable or failed contacting that may lead to functional malfunction. Please verify the atmosphere when storing and transporting.

13) Packaging should be designed to reduce as much as possible the potential influence of humidity, organic gas, and sulfide gas, etc.

14) Please avoid sudden changes in temperature. This is a cause of switch deformation and encourages the seal structure to breathe, which may lead to seal failure and operational malfunction.

15) If installing a thermoplastic resin case, the use of a spring washer tightened directly against the case will cause the case to collapse and become damaged. Therefore, please add a flat washer before tightening. Also, be careful not to install if the case is being twisted.

16) For the purpose of improving quality, materials and internal structure may be changed without notice.

17) When used outdoors (in places where there is exposure to direct sunlight or rain such as in multistory car parks) or in ambient temperature environments where ozone is generated, the influence of these environments may cause deterioration of the rubber material. Please consult us if you intend to use a switch in such environments.

---

## ■ PRECAUTIONS RELATING TO THE INSTALLATION ENVIRONMENT

Avoid using in silicon environments such as organic silicon-based rubber, solvents, sealants, oil, grease, or wiring.

# IMPROVEMENT EXAMPLES

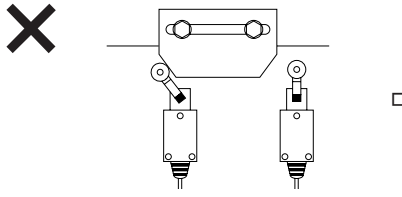
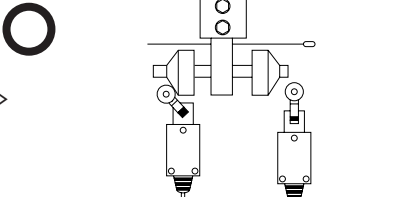
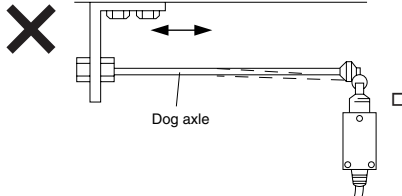
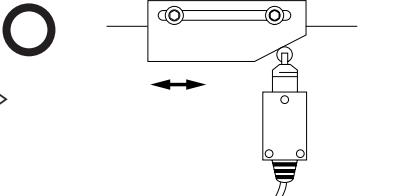
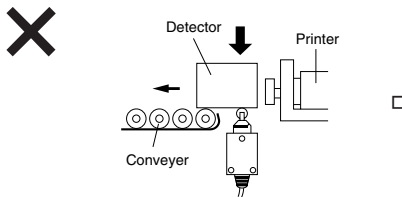
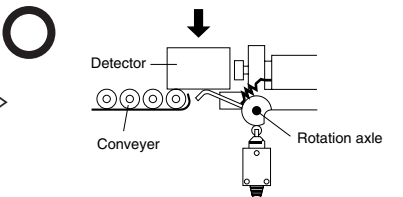
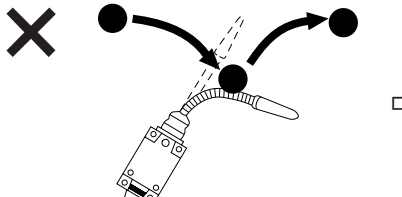
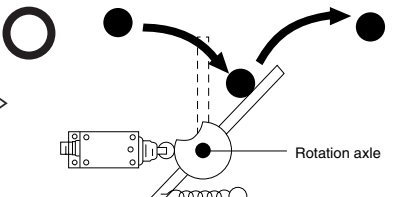
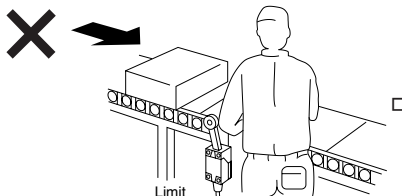
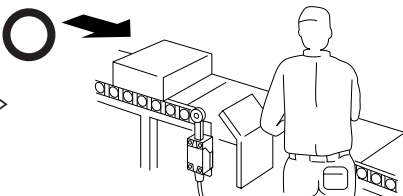
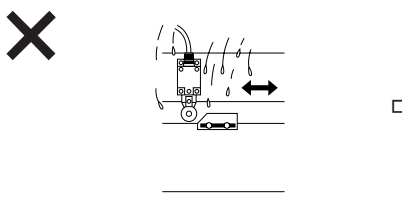
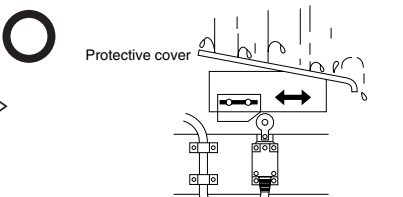
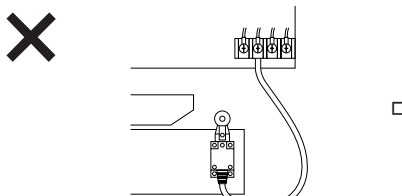
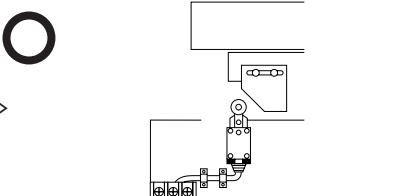
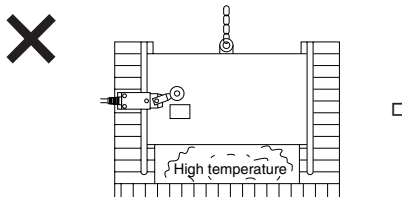
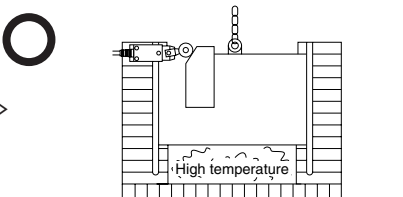



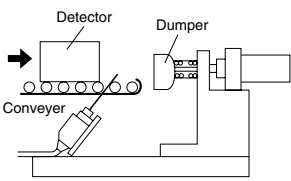
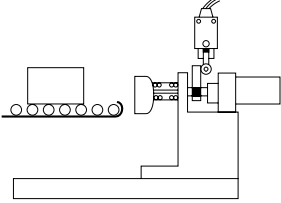
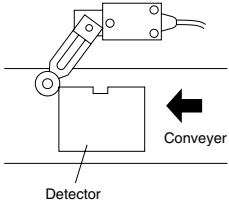
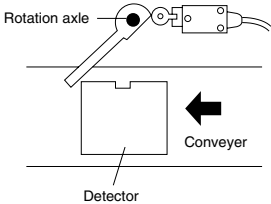
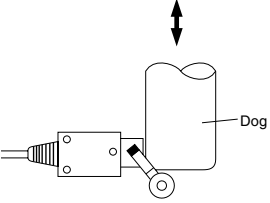
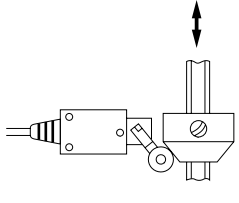
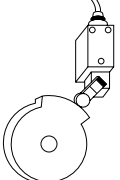
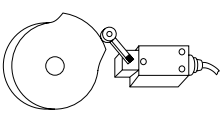

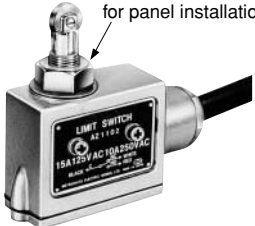

Poor design	Improved design	Explanation
		<ul style="list-style-type: none"> <li>■ Problem • Dog adjustment is difficult.</li> <li>■ Solution • Separate each one until the dog can be adjusted.</li> </ul>
		<ul style="list-style-type: none"> <li>■ Problem • The dog axis is too long, and slips out during operation.</li> <li>• For this reason, the limit switch operating position slips.</li> <li>■ Solution • Firmly fix the dog plate to the base.</li> </ul>
		<ul style="list-style-type: none"> <li>■ Problem • The detector sinks, applying force to the limit switch.</li> <li>• The limit switch O.T. cannot be set.</li> <li>■ Solution • Relieve the pressure using an additional actuator, and the O.T. can also be set.</li> </ul>
		<ul style="list-style-type: none"> <li>■ Problem • The area around the actuator coil is easily damaged.</li> <li>• Friction generated during operation.</li> <li>■ Solution • Relieve the friction by installing an additional actuator.</li> <li>• Change the type of limit switch.</li> </ul>
		<ul style="list-style-type: none"> <li>■ Problem • Workers keep bumping the actuator.</li> <li>■ Solution • Fit a protective cover to the side of the limit switch.</li> </ul>
		<ul style="list-style-type: none"> <li>■ Problem • Because the cord vent for the limit switch faces upwards, water droplets and so forth can easily penetrate the interior.</li> <li>• The cord is constantly moving and thus easily damaged.</li> <li>■ Solution • Fix the limit switch position on the stationary board.</li> <li>• Fit a protective cover, so that water and oil cannot come into direct contact with the limit switch.</li> </ul>
		<ul style="list-style-type: none"> <li>■ Problem • The cord is not fixed, and gets pulled during work.</li> <li>• Dog adjustment is ineffective.</li> <li>■ Solution • Change the limit switch position, and fix the cord.</li> <li>• Attach an adjustment mechanism to the dog.</li> </ul>
		<ul style="list-style-type: none"> <li>■ Problem • The limit switch is near a high-temperature area.</li> <li>• Dog adjustment is ineffective, and the dog keeps bumping the lever.</li> <li>■ Solution • Move the limit switch further away.</li> <li>• Make dog adjustment possible, and change the shape of the unit.</li> </ul>

# IMPROVEMENT EXAMPLES

Poor design	Improved design	Explanation
		<p>■ Problem</p> <ul style="list-style-type: none"> <li>• The detector is scratched.</li> <li>• Limit attachment adjustments are difficult</li> <li>• The actuator is damaged.</li> <li>• Specimen transfer is impeded.</li> </ul> <p>■ Solution</p> <ul style="list-style-type: none"> <li>• Fix the limit position to behind the dumper to solve the above problems.</li> </ul>
		<p>■ Problem</p> <ul style="list-style-type: none"> <li>• The transfer path of the detector is not fixed, and it keeps bumping the actuator.</li> <li>• The operating position is unstable.</li> <li>• The actuator is damaged.</li> </ul> <p>■ Solution</p> <ul style="list-style-type: none"> <li>• Stabilize the operating position by fitting an additional actuator.</li> <li>• Make limit switch adjustment possible.</li> </ul>
		<p>■ Problem</p> <ul style="list-style-type: none"> <li>• Stroke adjustment ineffective.</li> <li>• Release the limit switch position, and ensure that the dog does not bump the lever.</li> </ul> <p>■ Solution</p> <ul style="list-style-type: none"> <li>• Make dog adjustment possible.</li> <li>• Change the limit switch position, and sure that the dog does not bump the lever.</li> </ul>
		<p>■ Problem</p> <ul style="list-style-type: none"> <li>• The cam shape is unsuitable (especially during release and strike release.)</li> <li>• Direction of limit switch attachment is unsuitable.</li> </ul> <p>■ Solution</p> <ul style="list-style-type: none"> <li>• Render the cam shape smooth.</li> <li>• Change the limit switch position.</li> </ul>

# Table of Recommended Substitute Products for Discontinued Products

Products to be discontinued	Recommended substitute products	Page
AZ1 series Limit switches	➡ ML (AZ7) Limit switches	P.33
AZ2 series Limit switches	➡ ML (AZ7) Limit switches	P.33
Slitted type Limit switches (AZ6)	➡ ML (AZ7) Limit switches	P.33
New slitted type Limit switches (AZ66)	➡ ML (AZ7) Limit switches	P.33

Products to be discontinued	Recommended substitute products	Installation
AZ1*** 	AZ7*** 	Please note that installation method and operation characteristics are different.
AZ2*** 	AZ7*** 	Please note that installation method and operation characteristics are different.
AZ6*** 	AZ7*** 	Please note that installation method and operation characteristics are different.
AZ66*** 	AZ7*** 	Please note that installation method and operation characteristics are different.

# FOREIGN STANDARDS OVERVIEW

## 1. International Standards

### IEC standard

#### International Electrotechnical Commission

By promoting international cooperation toward all problems and related issues regarding standardization in the electrical and electronic technology fields, the IEC, a non-governmental organization, was started in October, 1908, for the purpose of realizing mutual understanding on an international level. To this end, the IEC standard was enacted for the purpose of promoting international standardization.

## 2. North America

#### UL (Underwriters Laboratories Inc.)

This is a non-profit testing organization formed in 1894 by a coalition of U.S. fire insurance firms, which tests and approves industrial products (finished products). When electrical products are marketed in the U.S., UL approval is mandated in many states, by state law and city ordinances. In order to obtain UL approval, the principal parts contained in industrial products must also be UL-approved parts.

UL approval is divided into two general types. One is called "listing" (Fig. 1), and applies to industrial products (finished products). Under this type of approval, products must be approved unconditionally. The other type is called "recognition" (Fig. 2), and is a conditional approval which applies to parts and materials.

#### CSA (Canadian Standards Association)

This was established in 1919 as a non-profit, non-governmental organization aimed at promoting standards. It sets standards for industrial products, parts, and materials, and has the authority to judge electrical products to determine whether they conform to those standards. The CSA is the ultimate authority in the eyes of both the government and the people in terms of credibility and respect. Almost all states and provinces in Canada require CSA approval by law, in order to sell electrical products. As a result, electrical products exported from Japan to Canada are not approved under Canadian laws unless they have received CSA approval and display the CSA mark. Approval is called "certification", and products and parts which have been approved are called "certified equipment", and display the mark shown in Fig. 3. The mark shown in Fig. 4 is called the "Component Acceptance" mark, and indicates conditional approval which is applicable to parts. The C-UL mark shown in Fig. 5 (finished products) and Fig. 6 (parts) indicates that the product has been tested and approved in UL laboratories, based on UL and CSA standards, through mutual approval activities.

LISTING MARK



Fig. 1

RECOGNITION MARK



Fig. 2

Certification



Fig. 3

Component Acceptance



Fig. 4



Fig. 5



Fig. 6

## 3. Europe

### EN standard

#### European Standards/Norme Europeennee (France)/Europaishe Norm (Germany)

Abbreviation for European Standards. A unified standard enacted by CEN/CENELEC (European Standards Committee/European Electrical Standards Committee). EU and EFTA member nations employ the content of the EN standards into their own national standards and are obligated to abolish those national standards that do not agree with the EN standards.

#### (1) Germany

#### VDE (Verband Deutscher Elektrotechniker)

The VDE laboratory was established mainly by the German Electric Technology Alliance, which was formed in 1893. It carries out safety experiments and passes approval for electrical devices and parts. Although VDE certification is not enforced under German law, punishment is severe should electrical shock or fire occur; therefore, it is, in fact, like an enforcement.



#### TÜV (Technischer Überwachungs-Verein)

TÜV is a civilian, non-profit, independent organization that has its roots in the German Boiler Surveillance Association, which was started in 1875 for the purpose of preventing boiler accidents. A major characteristic of TÜV is that it exists as a combination of 14 independent organizations (TÜV Rheinland, TÜV Bayern, etc.) throughout Germany. TÜV carries out inspection on a wide variety of industrial devices and equipment, and has been entrusted to handle electrical products, as well, by the government. TÜV inspection and certification is based mainly on the VDE standard. TÜV certification can be obtained from any of the 14 TÜVs throughout Germany and has the same effectiveness as obtaining VDE certification.

# SAFETY STANDARDS RECOGNITION

## Limit switches

Product name		UL recognized		CSA certified		TÜV approval	
		File No.	Approved ratings	File No.	Approved ratings	File No.	Approved ratings
SL limit switches		E122222	4A 250V AC	LR55880	4A 250V AC	–	–
HL limit switches	Dies-cast case standard load type	E122222	5A 250V AC Pilot duty B300	LR55880	5A 250V AC Pilot duty B300	J9650514	DC-12 1A 30V-
	Die-cast case low level load type (includes connector type)		0.1A 30V DC		0.1A 30V DC		DC-12 0.1A 30V-
	Plastic case standard load type		5A 250V AC Pilot duty B300		5A 250V AC Pilot duty B300	J9650515	AC-15 2A 250V~ DC-12 1A 30V-
	Plastic case low level load type		0.1A 30V DC		0.1A 30V DC		DC-12 0.1A 30V-
ML limit switches	Standard type	E122222	10A 250V AC	E122222 (C-UL)	10A 250V AC	J9551204	AC-15 2A 250V~
	Epoxy-sealed terminal type	–	–	–	–	–	–
	With lamp	–	–	–	–	–	–
QL limit switches		E122222	5A 250V AC	LR55880	5A 250V AC	–	–
VL limit switches	Standard type	E122222	5A 250V AC Pilot duty B300	E122222 (C-UL)	5A 250V AC Pilot duty B300	J9551203	AC-15 2A 250V~
	With neon lamp		–		–	–	–
DL limit switches		E122222	6A 380V AC Pilot duty A300	E122222 (C-UL)	6A 380V AC Pilot duty A300	J9551205	AC-15 2A 250V~
Vertical limit switches		E99838	10A 1/2HP 125V AC 6A 1/2HP 250V AC	–	–	–	–
Compact Magnetlimit	Standard type	E43149	5A 250V AC	E43149 (C-UL)	5A 250V AC	–	–
	Water-resistant type		2A 250V AC	E43149 (C-UL)	2A 250V AC	–	–
Magnetlimit		E122222	5A 250V AC Pilot duty B300	E122222 (C-UL)	5A 250V AC Pilot duty B300	–	–

# CE MARKINGS OVERVIEW

## Limit switches conforming to EN/IEC standards

The limit switches shown below conform to both EN and IEC standards, and may display the CE markings.

Product classification	Product name	Suitable standard	Approving body	File No.
Limit switches	HL	EN60947-5-1	TÜV	J9650514/J9650515
	ML	EN60947-5-1	TÜV	J9551204
	VL	EN60947-5-1	TÜV	J9551203
	DL	EN60947-5-1	TÜV	J9551205
	Magnetlimit	EN60947-5-1	–	–

Note: Refer to the page for each individual product for detailed approval conditions and approved types. Moreover, the HL limit switch alone does not display the CE mark as standard. If the CE mark is necessary, add (CE) to the end of the part No. when ordering.

## What are EN standards?

An abbreviation of Norme Européenne (in French), and called European Standards in English. Approval is by vote among the CEN/CENELEC member countries, and is a unified standards limited to EU member countries, but the contents conform to the international ISO/IEC standards.

If the relevant EN standard does not exist, it is necessary to obtain approval based on the relevant IEC standard or, if the relevant IEC standard does not exist, the relevant standard from each country, such as VDE, BS, SEMKO, and so forth.

## CE markings and EC directives

The world's largest single market, the European Community (EC) was born on 1 January 1993 (changing its name to EU in November 1993. It is now always expressed as EU, apart from EC directives.) EU member country products have always had their quality and safety guaranteed according to the individual standards of each member country. However, the standards of each country being different prevented the free flow of goods within the EU. For this reason, in order to eliminate non-tariff barriers due to these standards, and to maximize the merits of EU unification, the EC directives were issued concomitant to the birth of the EU.

The EN standards were established as universal EU standards in order to facilitate EU directives. These standards were merged with the international IEC standards and henceforth reflect the standards in all countries. Also, the CE markings show that products conform to EC directives, and guarantee the free flow of products within the EC.

## Appropriate EC directives for control equipment products

The main EC directives that are to do with machinery and electrical equipment are the machinery directive, the EMC directive, the low voltage directive, and the telecom directive. Although these directives have already been issued, the date of their enactment is different for each one. The machinery directive was 1 January 1995. The EMC directive was 1 January 1996, and the low voltage directive was enacted from 1 January 1997. The telecom directive was established by the separate CTR (Common Technology references.)