

SPECIFICATION

- Part No. : **GA.110.101111**
- Product Name : 2G/3G/4G High Gain
Magnetic Mount Ultra-wideband
Antenna
- Feature : LTE / GSM / CDMA /DCS /PCS / WCDMA /
UMTS / HSDPA / GPRS / EDGE /GPS /Wi-Fi
698MHz to 960MHz, 1575.42MHz,
1710MHz to 2700MHz, 3500MHz
1m RG174 Cable, SMA(M) Connector
Typical 40% Efficiency and 3dBi Peak Gain
Robust High Strength Super Magnet Mount
Custom cables and connectors available
RoHS Compliant

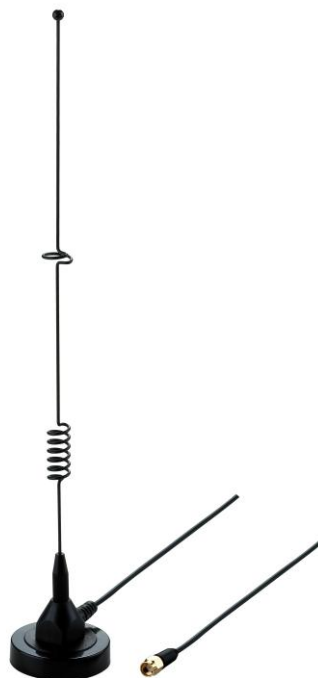

1. Introduction

The GA.110 magnetic ultra-wideband cellular antenna delivers stable high omni-directional gain and efficiencies across all common 2G, 3G and 4G global cellular bands from 700 MHz to 3.5 GHz.

This high performing antenna can be used for all cellular devices and will not require changing antennas when deploying from country to country or technology to technology like CDMA to GSM or 3G to 4G. Being magnetic mount it is designed to be mounted on a ground plane for optimal performance. A reliable return loss of <math><10\text{dB}</math> when mounted on a metal plate ensures it complies with the industry standards set by module makers and networks worldwide. Taoglas recommends using the antenna with 1m cable length or less and can provide customized connectors and cable lengths upon customer requirements.

The strong magnet base is extremely stable and robust, using only high quality neodymium magnets for a secure magnetic mount to ensure a high pull force to disengage.

2. Specification

| ELECTRICAL | | | | | | | | |
|----------------------------------|----------------------------|-------------|-------------|-------------|-------------|-------------|-------------|-------------|
| Frequency (MHz) | 698~800 | 824~960 | 1575.42 | 1710~1880 | 1850~1990 | 1710~2170 | 2400~2700 | 3500 |
| Peak Gain (dBi) | | | | | | | | |
| 30x30cm GP (1m RG174) | 1.8 | 2.6 | 1.3 | 2.5 | 2.3 | 3.9 | 2.9 | 0.6 |
| 30x30cm GP (2m RG174) | -1.0 | 0.9 | 0.9 | 3.9 | 2.8 | 2.5 | 2.2 | -0.6 |
| 30x30cm GP (3m RG174) | -2.5 | -0.1 | -1.3 | 1.2 | 0.1 | 1.2 | -0.5 | -1.6 |
| Average Gain (dBi) | | | | | | | | |
| 30x30cm GP (1m RG174) | -4.9 | -2.4 | -3.4 | -2.7 | -3.8 | -3.3 | -4.4 | -7.2 |
| 30x30cm GP (2m RG174) | -6.3 | -3.1 | -4.4 | -3.9 | -4.3 | -4.1 | -5.4 | -5.5 |
| 30x30cm GP (3m RG174) | -7.2 | -4.4 | -6.2 | -5.5 | -6.3 | -6.1 | -7.4 | -8.9 |
| Efficiency (%) | | | | | | | | |
| 30x30cm GP (1m RG174) | 33.6 | 57.1 | 46.2 | 55.0 | 41.8 | 47.8 | 36.9 | 19.0 |
| 30x30cm GP (2m RG174) | 23.9 | 48.7 | 36.5 | 41.3 | 37.3 | 39.5 | 29.0 | 28.0 |
| 30x30cm GP (3m RG174) | 19.7 | 36.2 | 24.0 | 28.5 | 21.8 | 25.0 | 19.0 | 13.0 |
| Impedance | 50Ω | | | | | | | |
| Polarization | Linear | | | | | | | |
| Radiation Pattern | Omni | | | | | | | |
| Input Power | 50 W | | | | | | | |
| MECHANICAL | | | | | | | | |
| Base Diameter | 50mm | | | | | | | |
| Whip Diameter | 298mm | | | | | | | |
| Whip Material | Coated Brass | | | | | | | |
| Connector | SMA Male | | | | | | | |
| ENVIRONMENTAL | | | | | | | | |
| Temperature Range | -40°C to 85°C | | | | | | | |
| Humidity | Non-condensing 65°C 95% RH | | | | | | | |

3. Antenna Characteristics

3.1 Return Loss

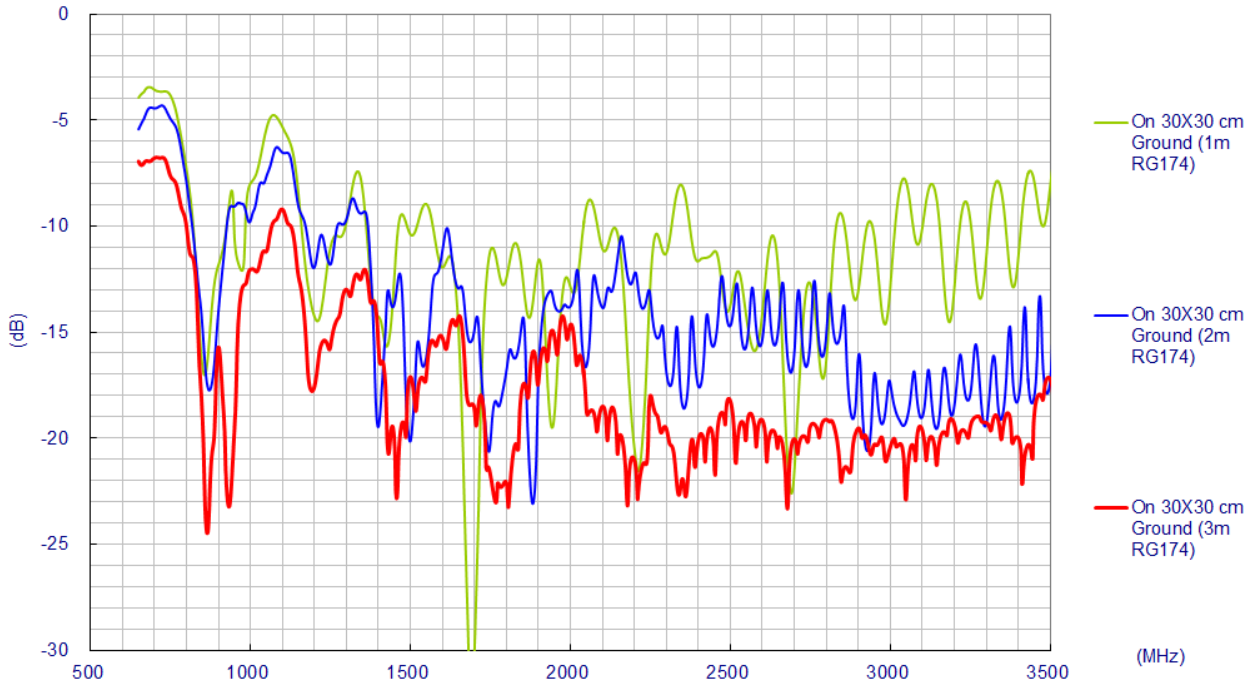

3.2 Maximum Gain

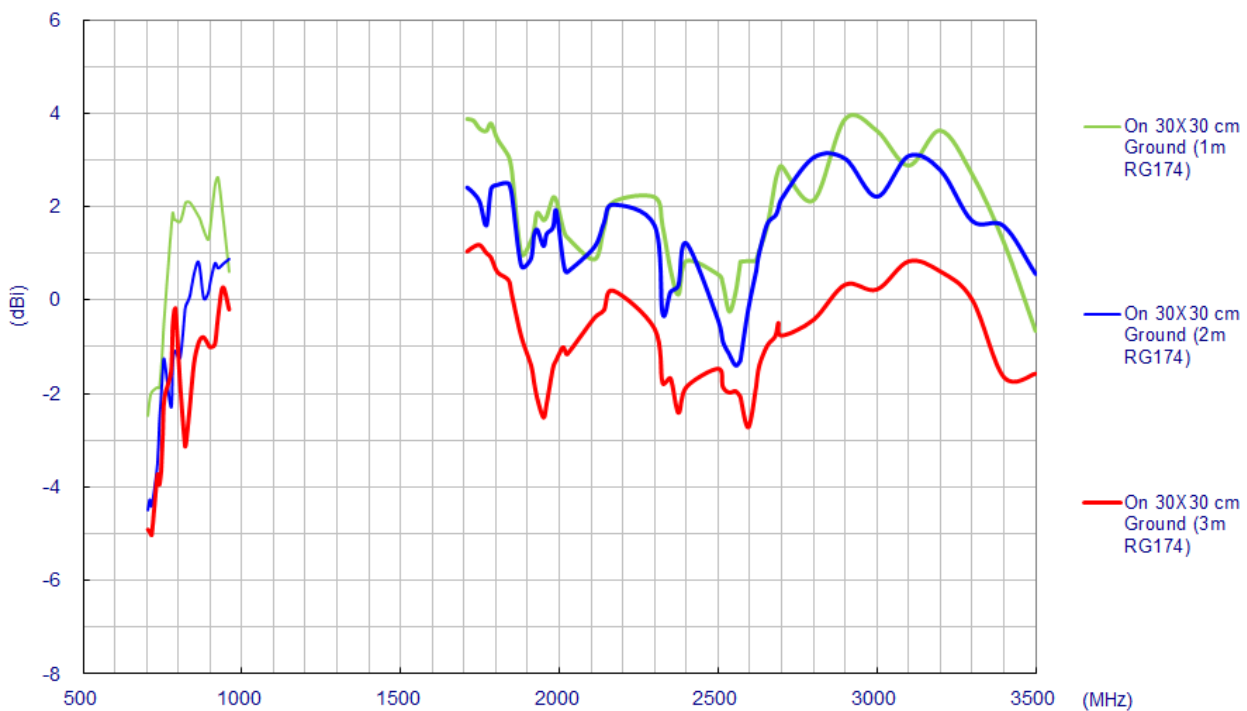

3.3 Average Gain

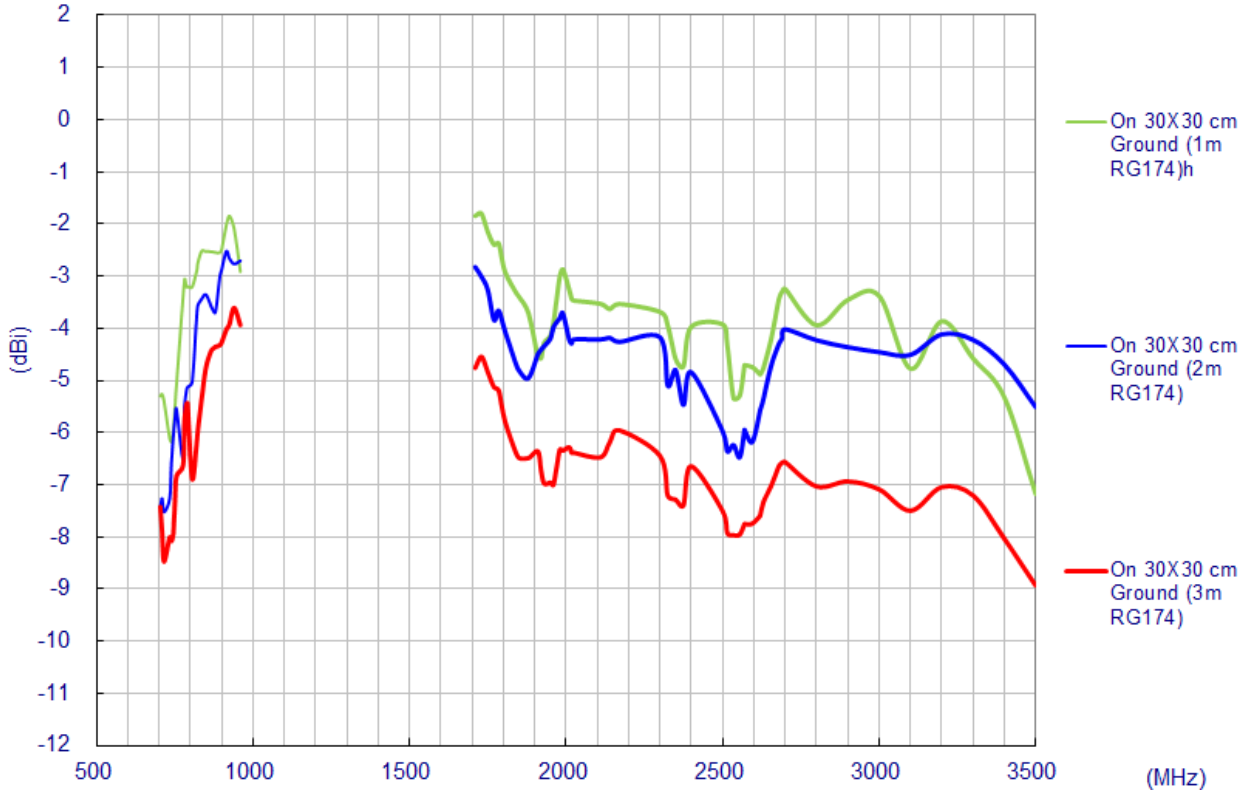

3.4 Efficiency

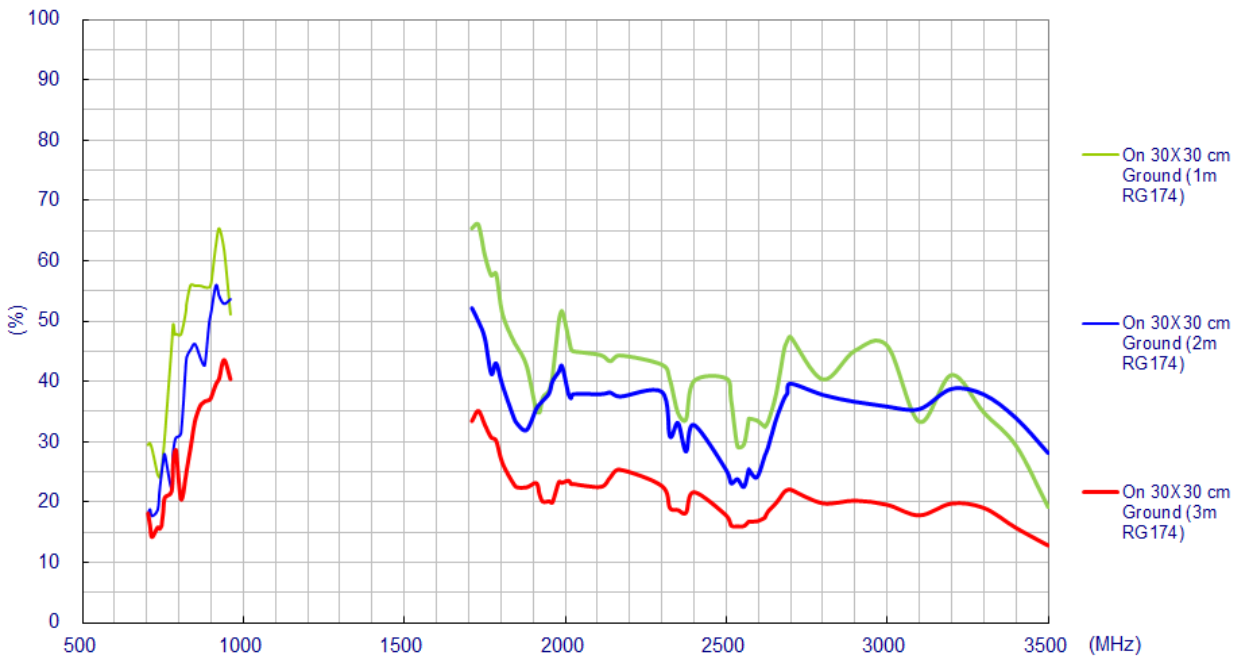

4. Antenna Radiation Patterns

4.1 Antenna setup (On 300x300mm ground plane with 1m RG174 cable)

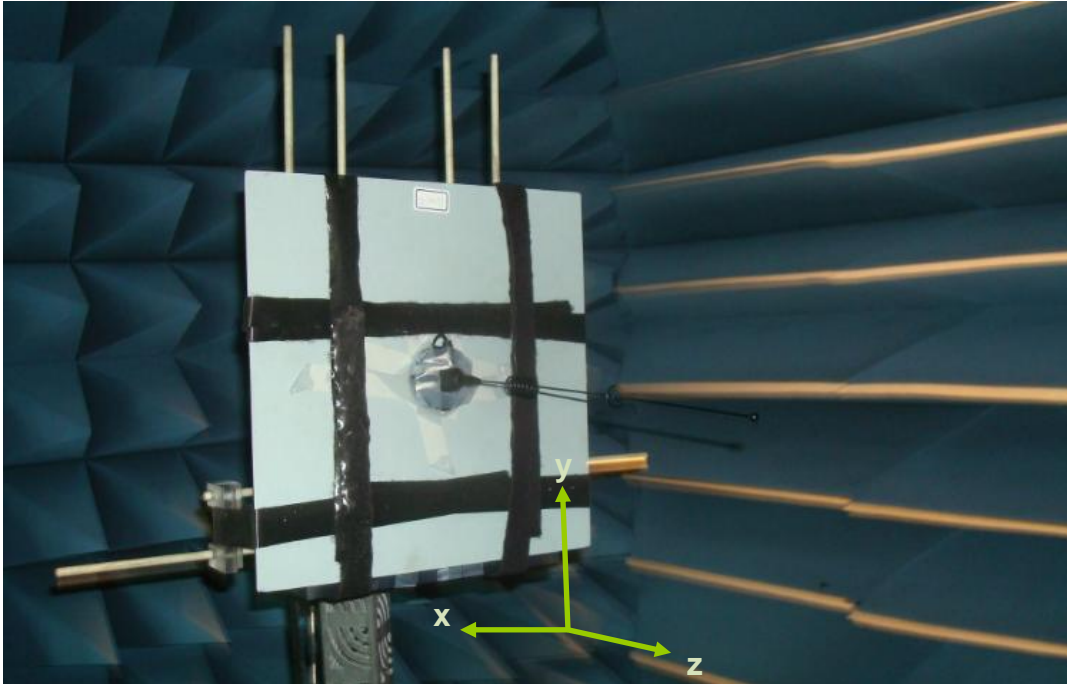

Radiation Patterns

XY plane

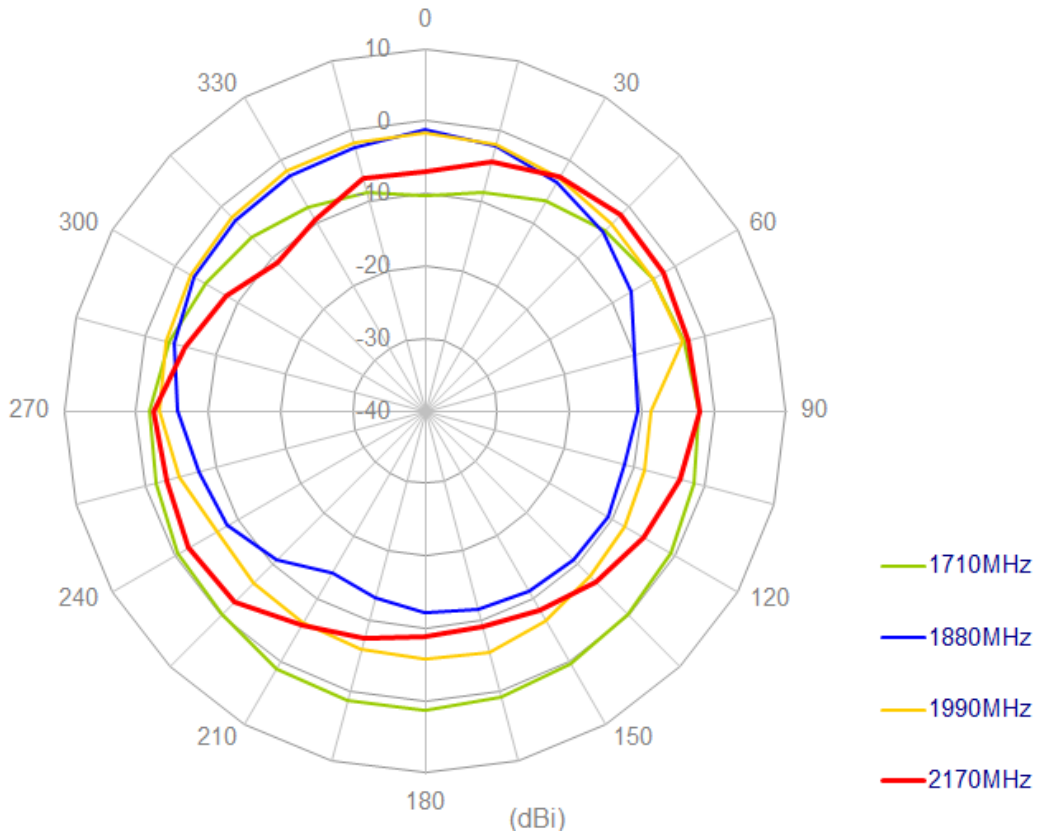
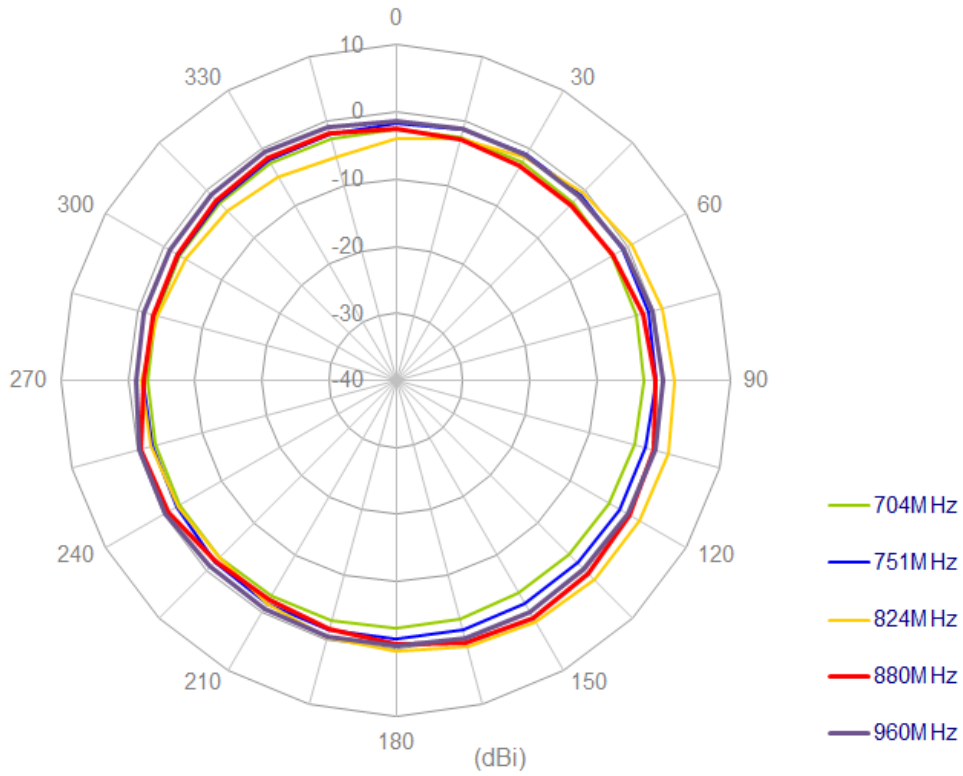

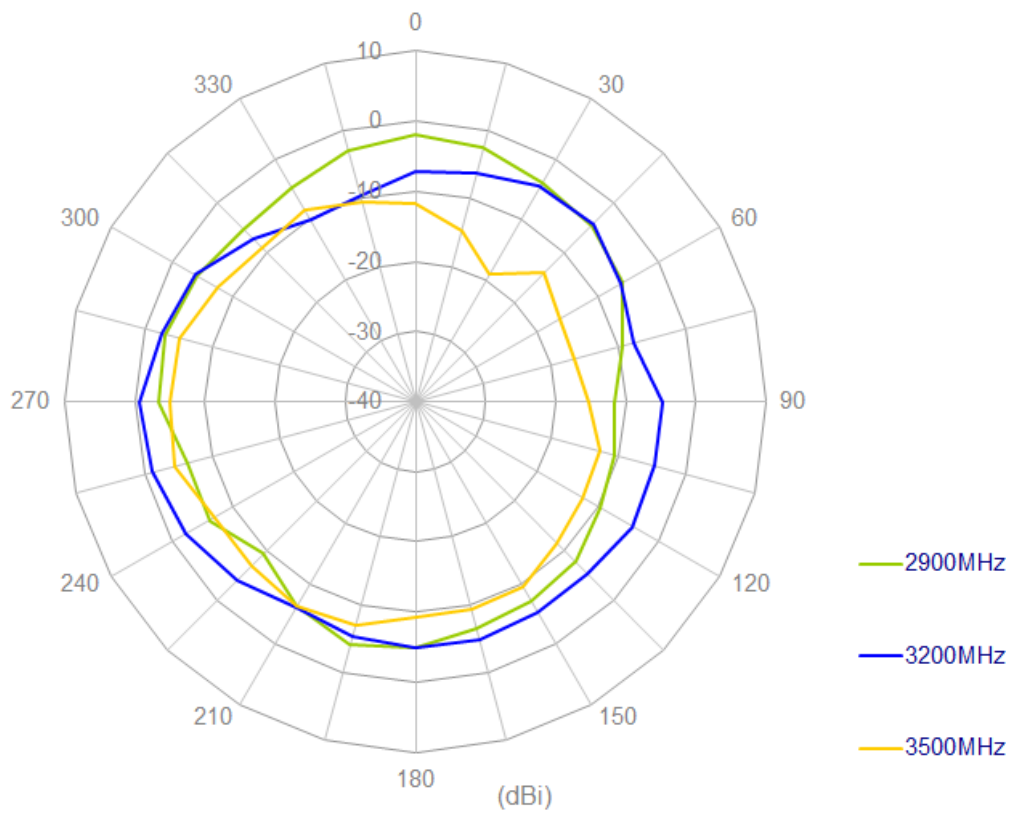
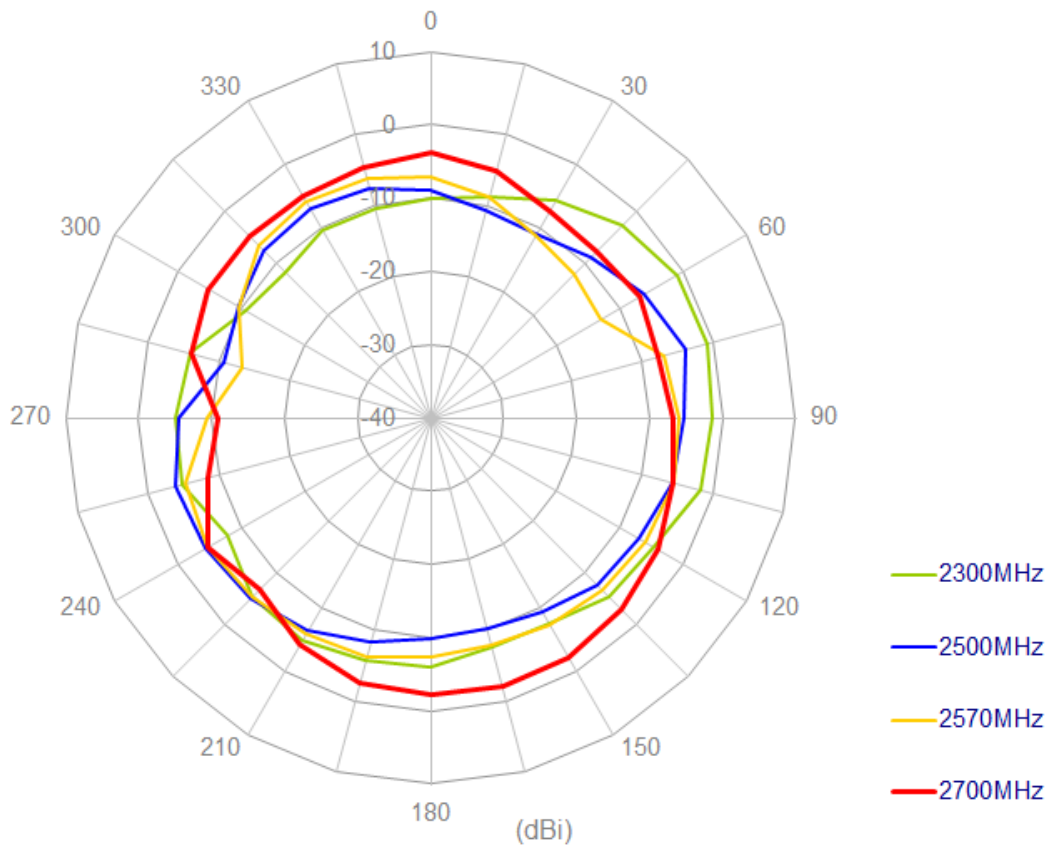

XZ plane

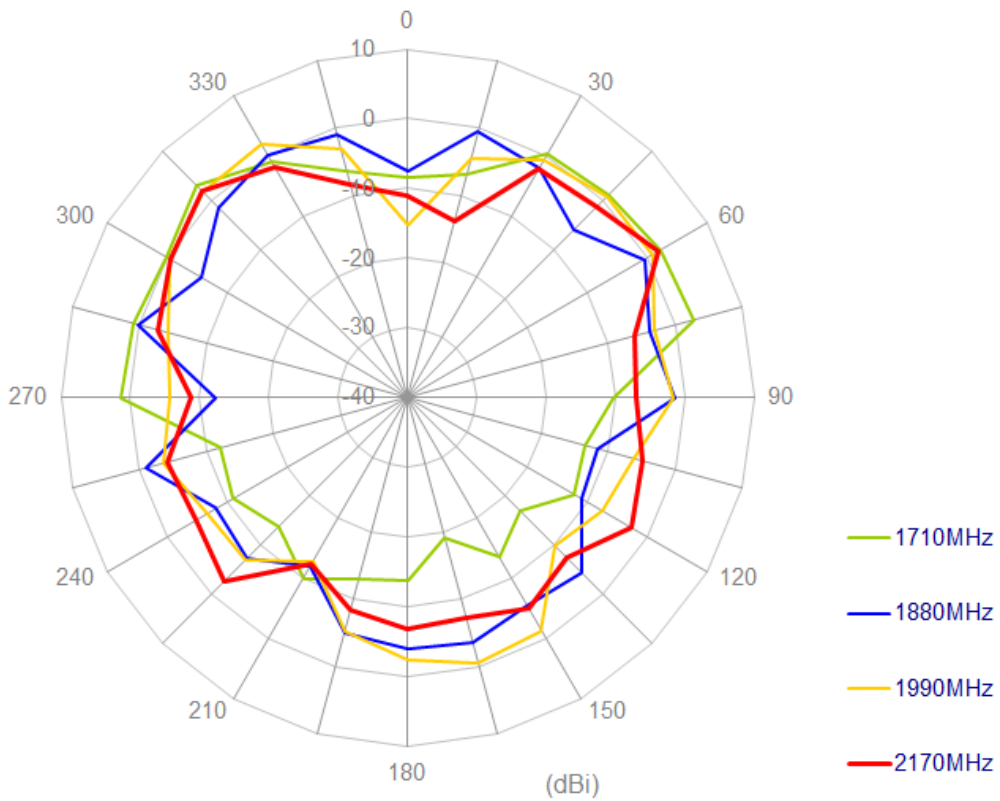
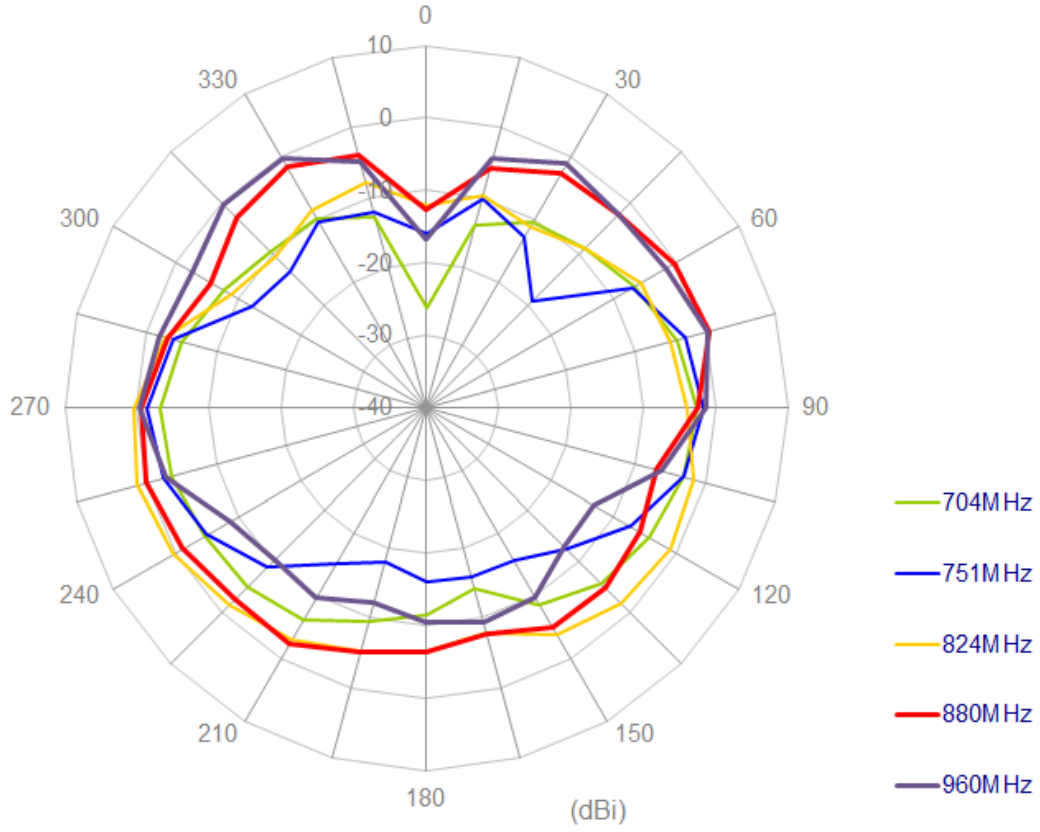

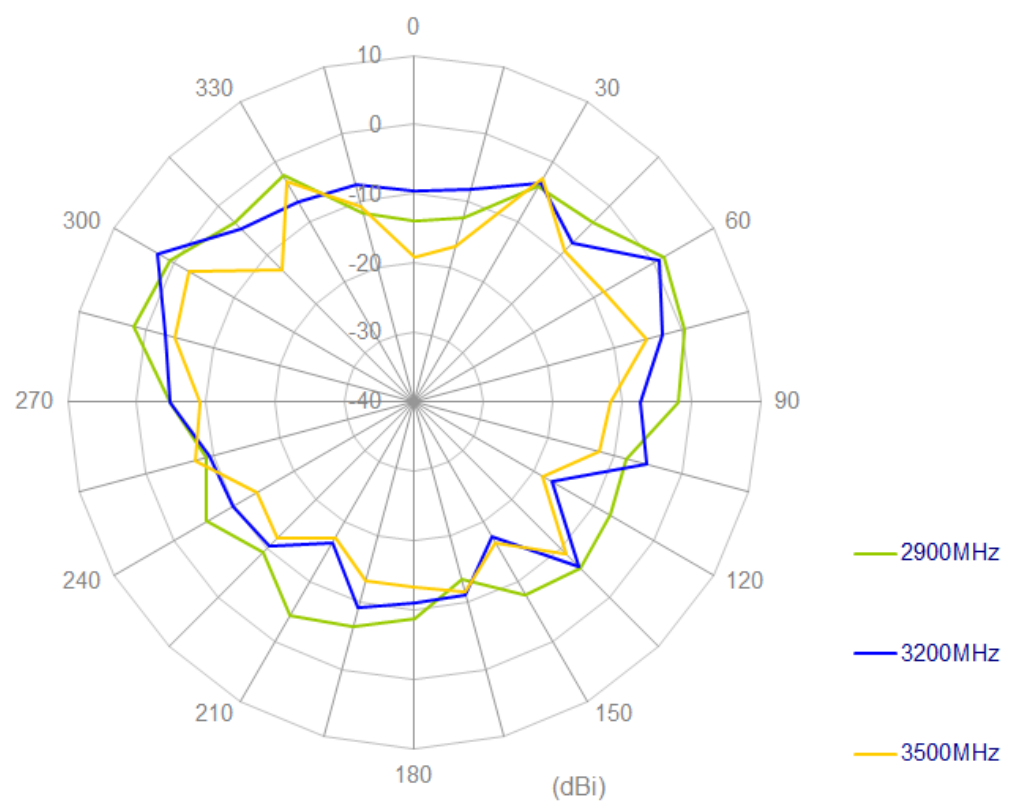
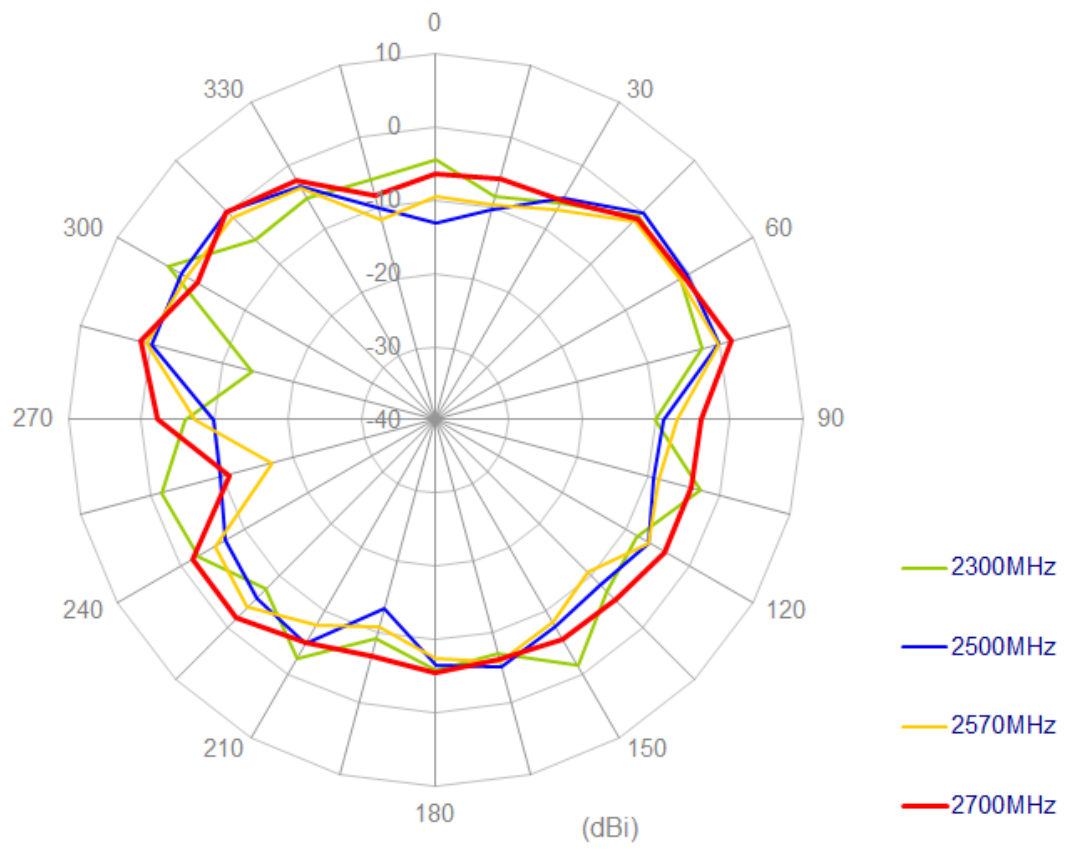

5. Drawing

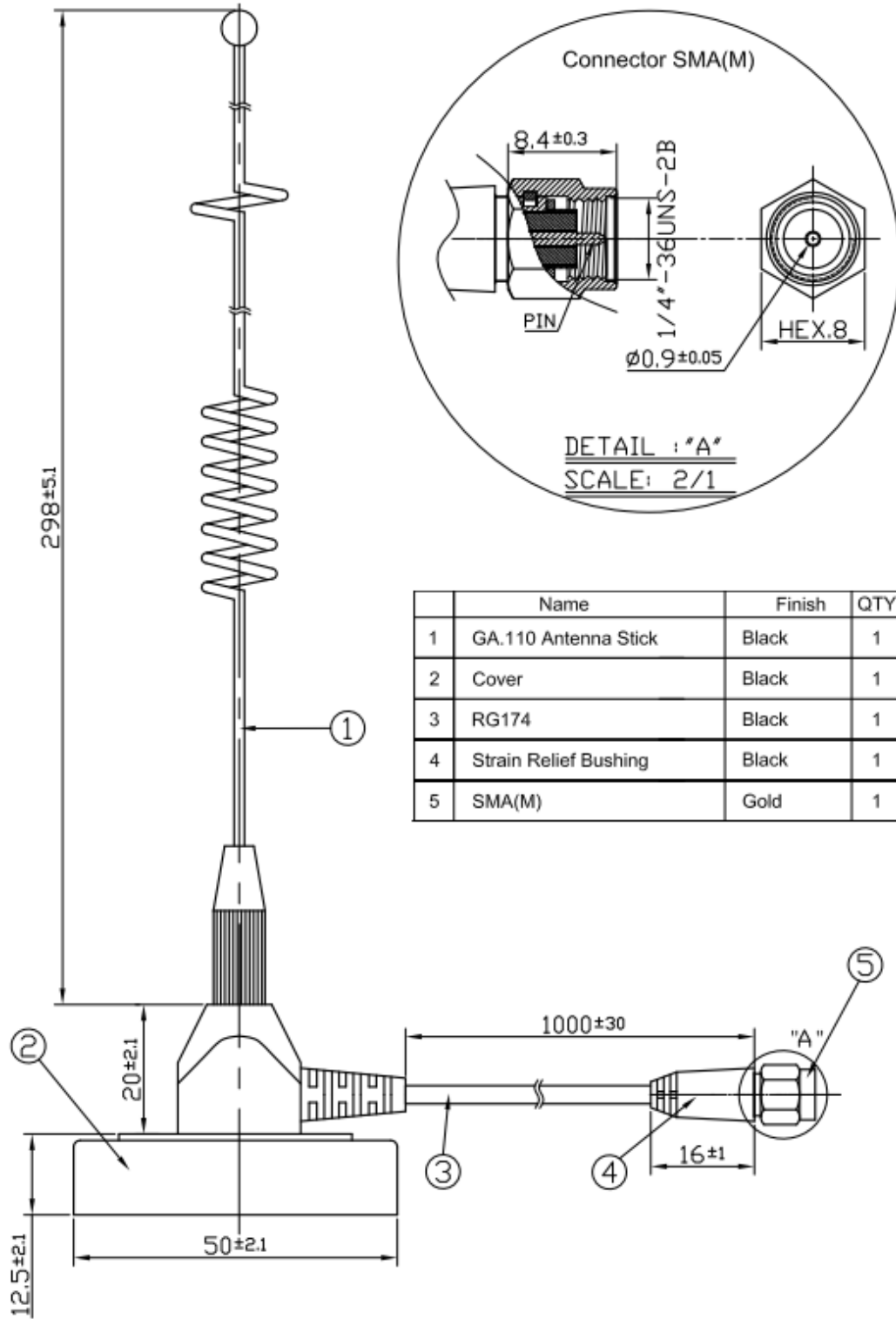

| | Name | Finish | QTY |
|---|-----------------------|--------|-----|
| 1 | GA.110 Antenna Stick | Black | 1 |
| 2 | Cover | Black | 1 |
| 3 | RG174 | Black | 1 |
| 4 | Strain Relief Bushing | Black | 1 |
| 5 | SMA(M) | Gold | 1 |

Taoglas makes no warranties based on the accuracy or completeness of the contents of this document and reserves the right to make changes to specifications and product descriptions at any time without notice. Taoglas reserves all rights to this document and the information contained herein. Reproduction, use or disclosure to third parties without express permission is strictly prohibited. Copyright © 2012, Taoglas Ltd.