

Performance Parameters

1MD04-019-XX

| Type | ΔT_{\max} K | Q_{\max} W | I_{\max} A | U_{\max} V | AC R Ohm | H mm |
|---------------------|------------------------|-----------------|-----------------|-----------------|-------------|---------|
| 1MD04-019-xx (N=19) | | | | | | |
| 1MD04-019-03 | 69 | 3.40 | 2.4 | 2.4 | 0.73 | 0.9 |
| 1MD04-019-05 | 71 | 2.14 | 1.5 | | 1.20 | 1.1 |
| 1MD04-019-08 | 73 | 1.38 | 0.9 | | 1.90 | 1.4 |
| 1MD04-019-10 | 73 | 1.11 | 0.8 | | 2.37 | 1.6 |
| 1MD04-019-12 | 73 | 0.93 | 0.6 | | 2.84 | 1.8 |
| 1MD04-019-15 | 73 | 0.75 | 0.5 | | 3.54 | 2.1 |

Performance data are given for 300K, vacuum

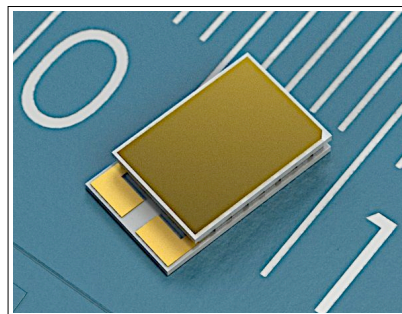

Dimensions

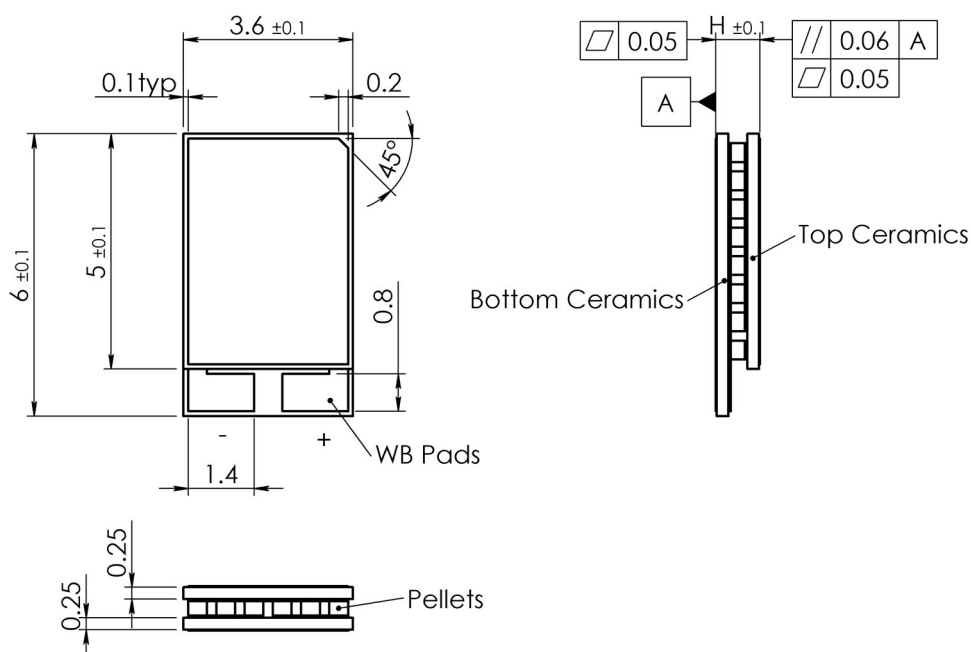

Manufacturing options

A. TEC Assembly:

- * 1. Solder SnSb ($T_{\text{melt}}=230^{\circ}\text{C}$)
- 2. Solder AuSn ($T_{\text{melt}}=280^{\circ}\text{C}$)

B. Ceramics:

- * 1. Pure Al_2O_3 (100%)
- 2. Alumina (Al_2O_3 - 96%)
- 3. Aluminum Nitride (AlN)

* - used by default

C. Ceramics Surface Options:

- 1. Blank ceramics (not metallized)
- 2. Metallized (Au plating)
- 3. Metallized and pre-tinned with:
 - 3.1 Solder 117 (In-Sn, $T_{\text{melt}} = 117^{\circ}\text{C}$)
 - 3.2 Solder 138 (Sn-Bi, $T_{\text{melt}} = 138^{\circ}\text{C}$)
 - 3.3 Solder 143 (In-Ag, $T_{\text{melt}} = 143^{\circ}\text{C}$)
 - 3.4 Solder 157 (In, $T_{\text{melt}} = 157^{\circ}\text{C}$)
 - 3.5 Solder 183 (Pb-Sn, $T_{\text{melt}} = 183^{\circ}\text{C}$)
 - 3.6 Optional (specified by Customer)

D. Thermistor (optional)

Can be mounted to cold side ceramics edge. Calibration is available by request.

E. Terminal contacts

- 1. Blank, tinned Copper
- 2. Insulated Wires
- 3. Insulated, color coded

Performance Data

1MD04-019-03

| @ 27°C, Vacuum | ΔT_{max} K | Q_{max} W | I_{max} A | U_{max} V |
|----------------|-----------------------|----------------|----------------|----------------|
| 1MD04-019-03 | 69 | 3.40 | 2.4 | 2.4 |

| @50°C, N2 | ΔT_{max} K | Q_{max} W | I_{max} A | U_{max} V |
|--------------|-----------------------|----------------|----------------|----------------|
| 1MD04-019-03 | 74 | 3.71 | 2.4 | 2.6 |

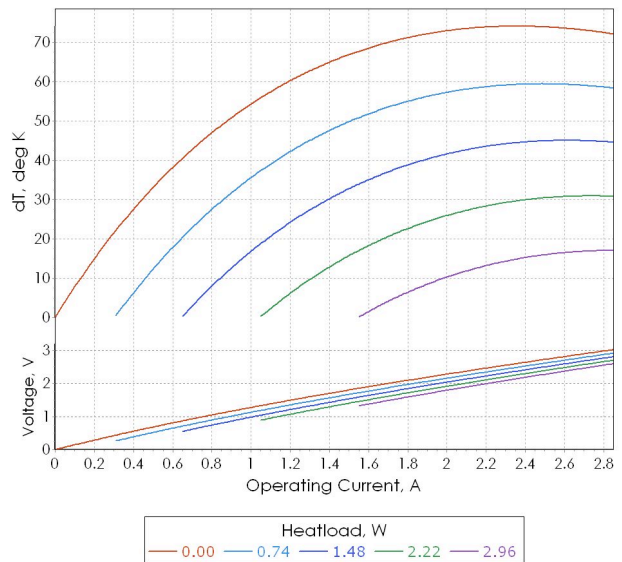
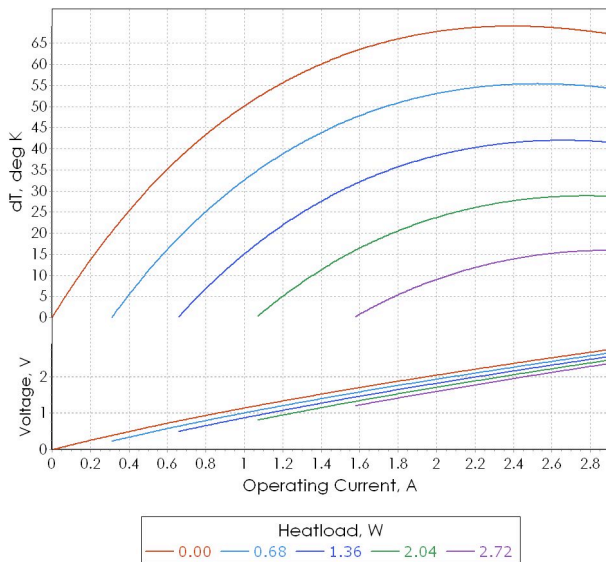

Note: Performance data is specified for optimal optimal conditions (TEC hot side is stabilized at ambient temperature). Heatsink thermal resistance is not included into estimations. Use TECCad Software for estimations under different conditions.

Performance Data

1MD04-019-05

| @ 27°C, Vacuum | ΔT_{max} K | Q_{max} W | I_{max} A | U_{max} V |
|----------------|-----------------------|----------------|----------------|----------------|
| 1MD04-019-05 | 71 | 2.14 | 1.5 | 2.4 |

| @50°C, N2 | ΔT_{max} K | Q_{max} W | I_{max} A | U_{max} V |
|--------------|-----------------------|----------------|----------------|----------------|
| 1MD04-019-05 | 76 | 2.34 | 1.5 | 2.6 |

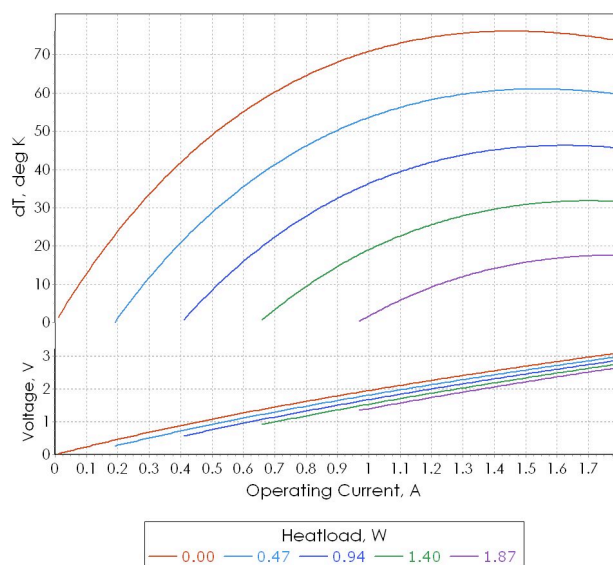
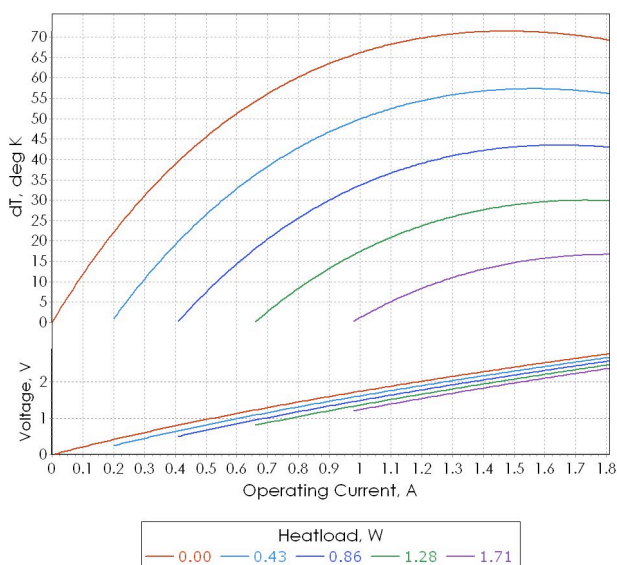

Note: Performance data is specified at optimal optimal conditions (TEC hot side is stabilized at ambient temperature). Any heatsink thermal resistance is not included into estimations. Use TECCad Software for estimations under different conditions.

Performance Data

1MD04-019-08

| @ 27°C, Vacuum | ΔT_{max} K | Q_{max} W | I_{max} A | U_{max} V |
|----------------|-----------------------|----------------|----------------|----------------|
| 1MD04-019-08 | 73 | 1.38 | 0.9 | 2.4 |

| @50°C, N2 | ΔT_{max} K | Q_{max} W | I_{max} A | U_{max} V |
|--------------|-----------------------|----------------|----------------|----------------|
| 1MD04-019-08 | 77 | 1.50 | 0.9 | 2.6 |

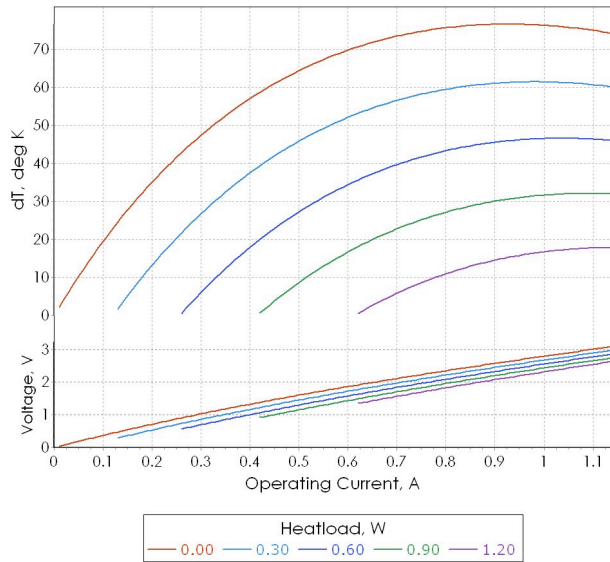
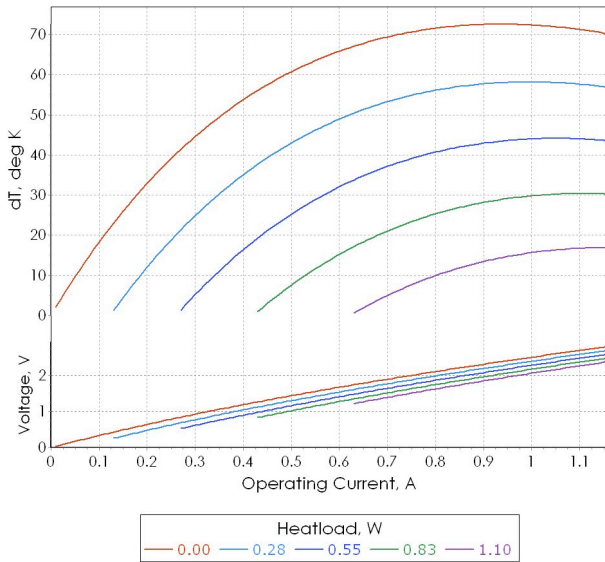

Note: Performance data is specified for optimal optimal conditions (TEC hot side is stabilized at ambient temperature). Heatsink thermal resistance is not included into estimations. Use TECCad Software for estimations under different conditions.

Performance Data

1MD04-019-10

| @ 27°C, Vacuum | ΔT_{max} K | Q_{max} W | I_{max} A | U_{max} V |
|----------------|-----------------------|----------------|----------------|----------------|
| 1MD04-019-10 | 73 | 1.11 | 0.8 | 2.4 |

| @50°C, N2 | ΔT_{max} K | Q_{max} W | I_{max} A | U_{max} V |
|--------------|-----------------------|----------------|----------------|----------------|
| 1MD04-019-10 | 76 | 1.21 | 0.8 | 2.6 |

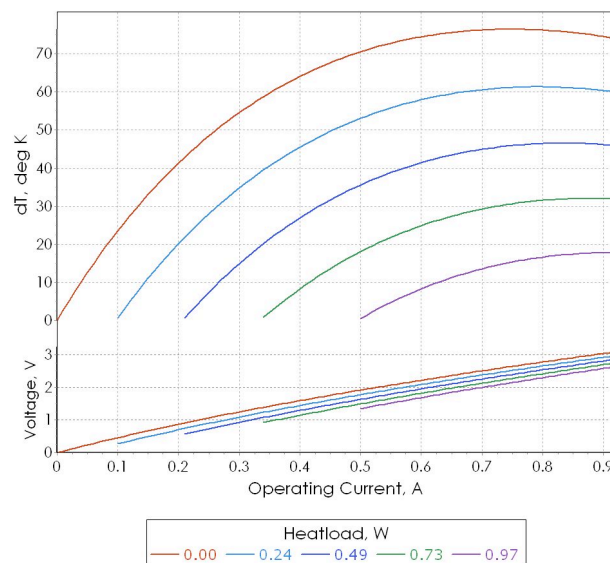
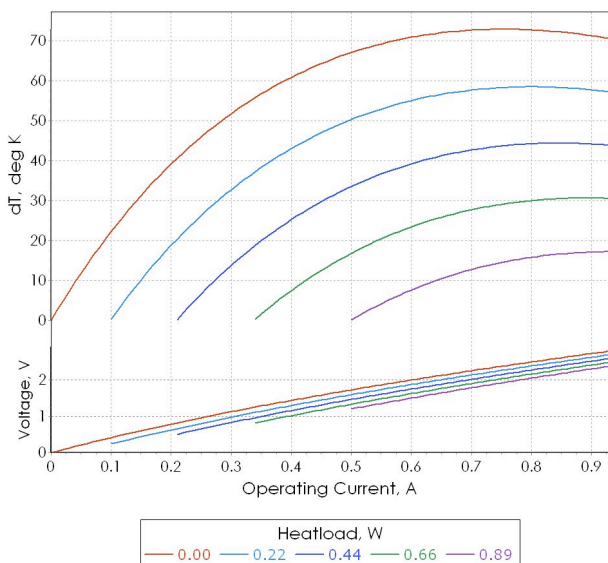

Note: Performance data is specified for optimal optimal conditions (TEC hot side is stabilized at ambient temperature). Heatsink thermal resistance is not included into estimations. Use TECCad Software for estimations under different conditions.

Performance Data

1MD04-019-12

| @ 27°C, Vacuum | ΔT_{max} K | Q_{max} W | I_{max} A | U_{max} V |
|----------------|-----------------------|----------------|----------------|----------------|
| 1MD04-019-12 | 73 | 0.93 | 0.6 | 2.4 |

| @50°C, N2 | ΔT_{max} K | Q_{max} W | I_{max} A | U_{max} V |
|--------------|-----------------------|----------------|----------------|----------------|
| 1MD04-019-12 | 76 | 1.02 | 0.6 | 2.6 |

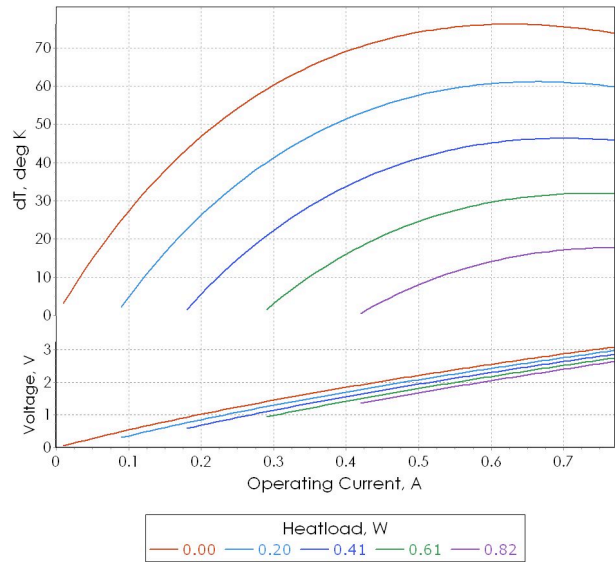
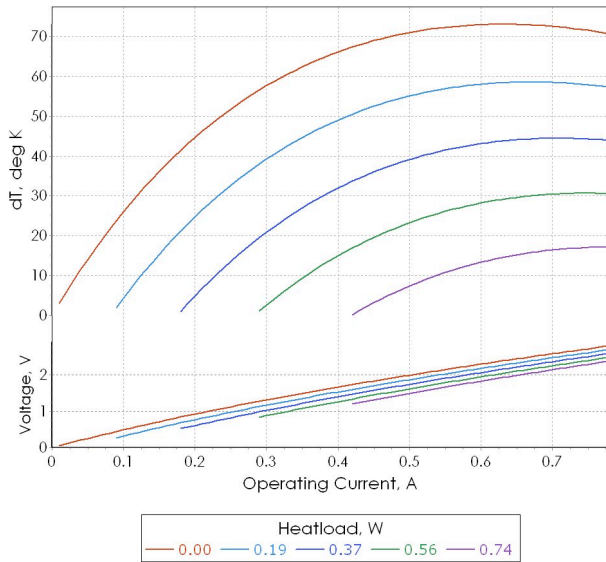

Note: Performance data is specified for optimal optimal conditions (TEC hot side is stabilized at ambient temperature). Heatsink thermal resistance is not included into estimations. Use TECCad Software for estimations under different conditions.

Performance Data

1MD04-019-15

| @ 27°C, Vacuum | ΔT_{max} K | Q_{max} W | I_{max} A | U_{max} V |
|----------------|-----------------------|----------------|----------------|----------------|
| 1MD04-019-15 | 73 | 0.75 | 0.5 | 2.4 |

| @50°C, N2 | ΔT_{max} K | Q_{max} W | I_{max} A | U_{max} V |
|--------------|-----------------------|----------------|----------------|----------------|
| 1MD04-019-15 | 76 | 0.82 | 0.5 | 2.6 |

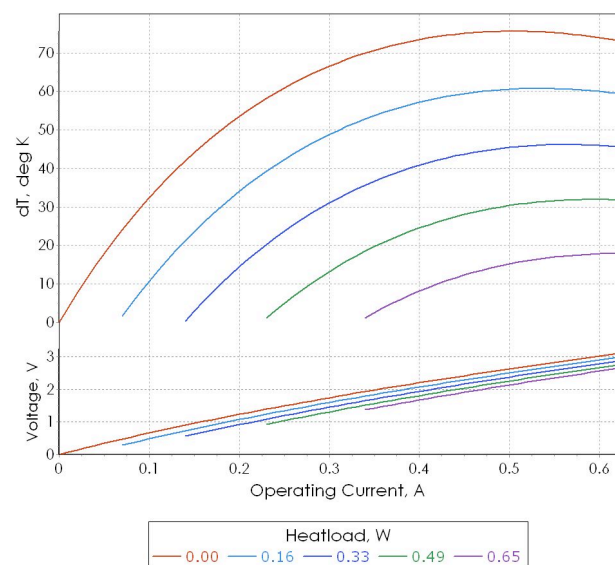
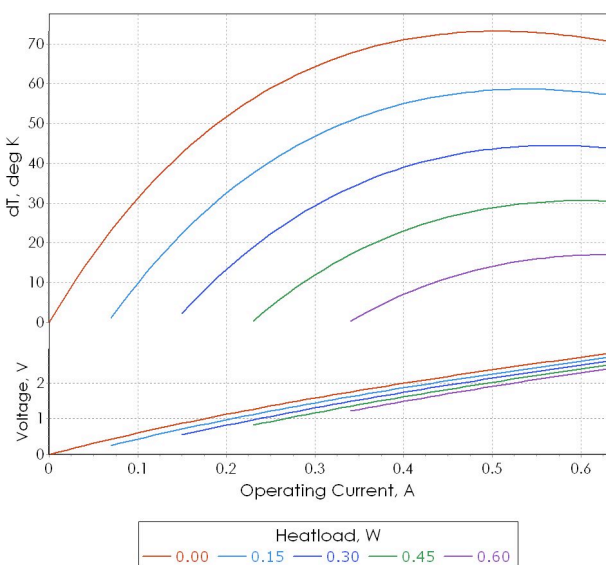

Note: Performance data is specified for optimal optimal conditions (TEC hot side is stabilized at ambient temperature). Heatsink thermal resistance is not included into estimations. Use TECCad Software for estimations under different conditions.

Additional Options

TEC Polarity

TEC Polarity can be modified by request. The specified polarity in this datasheet is typical. It can be reversed in accordance to Customer application requirements.

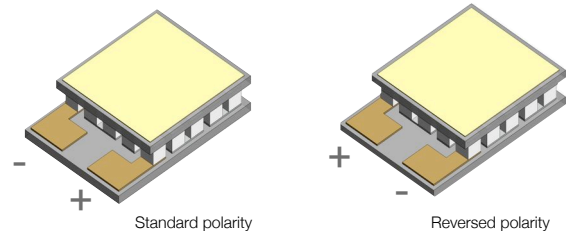

Terminal Wires Options

The standard solution is based on WB pads. Terminal Wires can be attached by request. Various options for terminal wires are available. (blank, isolated wires, isolated color-coded wires, flexible multicore wires and etc).

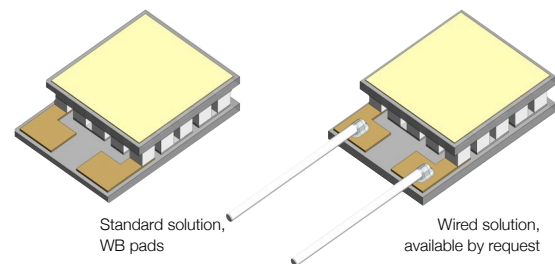

Optimization for WB process

The solution with WB pads (no posts) is provided by default. WB posts are available by request. The dimensions of WB posts can be modified and optimized for Customers application. WB posts are made of Copper, Au plated.

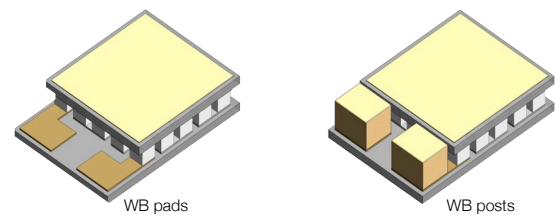

Customized Au Patterns

Customized Au patterns on thermoelectric cooler cold side are available by request. Selective Pre-tinning over pattern is also available. Please, contact RMT Ltd for additional information about customized Au patterns requirements.

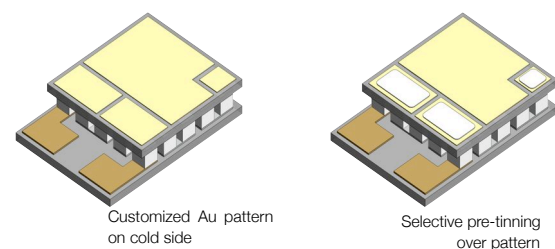

TEC Height modification

Standard TEC height can be modified without performance changes by using ceramics of different thickness. Standard thermoelectric cooler height (specified in this datasheet) can be increased in a range 0.25..1.5 mm by request.

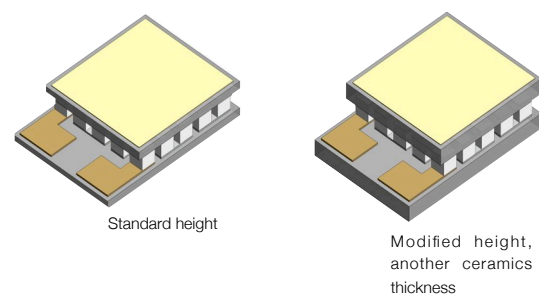

Thermoelectric Cooler Overview

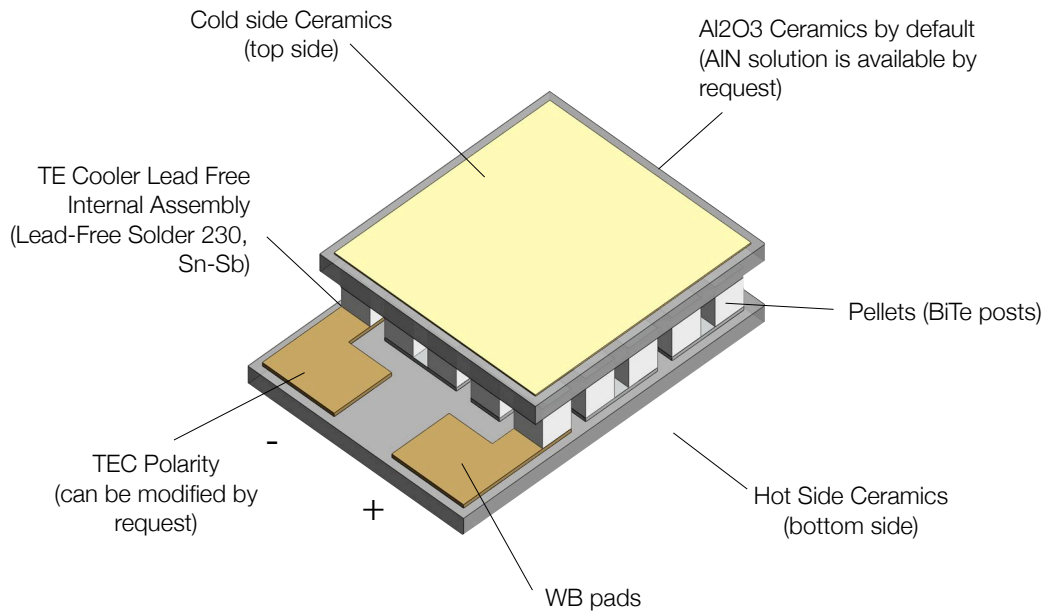

Application Tips

- | | |
|---|---|
| <ol style="list-style-type: none"> 1. Never heat TE module more than 200°C (TEC assembled at 230°C). 2. Never use TE module without an attached heat sink at hot (bottom) side. | <ol style="list-style-type: none"> 1. Connect TE module to DC power supply according to polarity. 2. Do not apply DC current higher than I_{max}. |
|---|---|

Installation

1. Mechanical Mounting. TEC is placed between two heat exchangers . This construction is fixed by screws or in another mechanical way. It is suitable for large modules (with dimensions 30x30mm and larger). Miniature types require other assembling methods in most cases.
1. Soldering. This method is suitable for a TE module with metallized outside surfaces. RMT provides this option and also makes pre-tinning for TE modules.
2. Glueing. It is an up-to-date method that is used by many customers due to availability of glues with good thermoconductive properties. A glue is usually based on some epoxy compound filled with some thermoconductive material such as graphite or diamond powders, silver, SiN and others. The application of a specific type depends on application features and the type of a TE module.

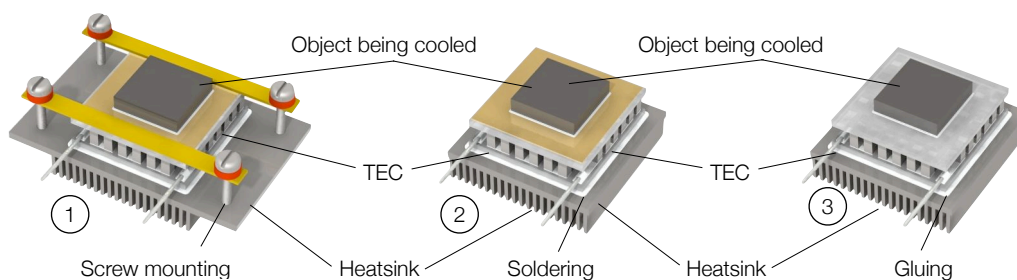

Contacts

RMT Ltd. Headquarters

Warshavskoe sh. 46, 115230, Moscow

Russia

Phone: +7-499-678-2082

Fax: +7-499-678-2083

Web: www.rmtltd.ru

Email: info@rmtltd.ru

EUROPE/USA - TEC Microsystems GmbH

Schwarzschildstrasse 3, 12489 Berlin

Germany

Tel. +49 30 6789 3314

Fax+49 30 6789 3315

Web: www.tec-microsystems.com

Email: info@tec-microsystems.com

CHINA - ProTEC Ltd.

深圳市南山区登良路恒裕中心B座207

电话：+86-755-61596066

传真：+86-755-61596036

邮编：518054

Web: www.protecltd.com

Email: info@protecltd.com