

2A Step-Down Converter with Adjustable Input Current Limit

General Description

The AAT1138 is a 2A synchronous step-down converter with an integrated current-limiting load switch designed for precise input current control applications. By guarding against excessive input current, the AAT1138 enables the system designer to maximize the output current from the step-down converter while protecting the input supply. It is designed for protection of 5V USB ports and 3.3V supplies from heavy load transient conditions commonly seen with high data rate modem applications.

The AAT1138 integrates a programmable current limited P-channel MOSFET load switch to protect the input supply against large currents which may cause the supply to fall out of regulation. Current limit threshold is programmed by an external resistor from SET to ground. It can be adopted to control loads of the input supply that requires up to 1.4A.

The AAT1138's internal step-down converter is a 2A, 1.2MHz constant frequency current mode PWM step-down converter. The step-down converter can run at 100% duty cycle for low dropout operation. The output voltage can be regulated as low as 0.6V.

The AAT1138 is available in a Pb-free, low profile, 16-pin 3mm x 4mm TDFN package. The product is rated over the -40°C to 85°C temperature range.

Features

- V_{IN} Range: 2.5V to 5.5 V
- V_{OUT} Range: 0.6V to V_{PVIN}
- System Current Limited Load Switch
 - Programmable Over-Current Threshold
 - < 1 μ s Fast Transient Response to Short Current
 - 145m Ω Typical $R_{DS(ON)}$
- Step-Down Converter
 - Up to 2A Output Current
 - 95% Peak Efficiency
 - 1.2MHz Switching Frequency
 - 135m Ω Low $R_{DS(ON)}$ Internal Switches
 - 100% Duty Cycle Low Dropout Operation
 - Soft Start
- Under-Voltage Lockout
- Independent Enable Pins
- <2 μ A Shutdown Current
- Over-Temperature and Current Limit Protection
- Low Profile 16-pin 3mm x 4mm TDFN Package
- -40°C to 85°C Temperature Range

Applications

- Cellular Phones
- MP3 Players
- PDAs and Handheld Computers
- Portable Media Players
- USB Devices

Typical Application

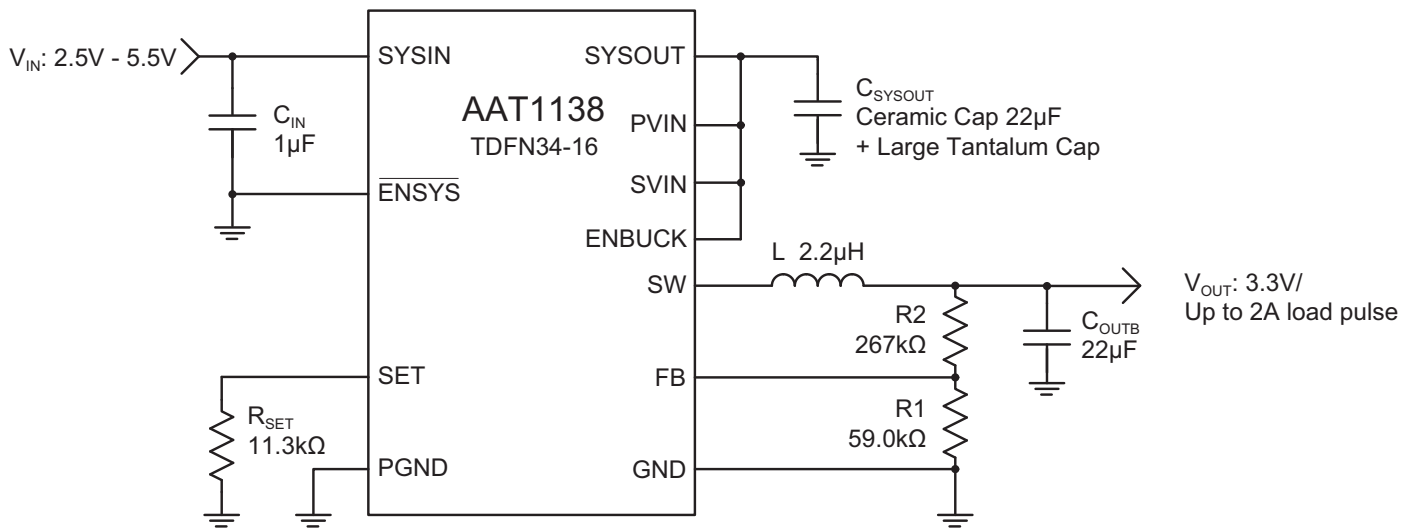

2A Step-Down Converter with Adjustable Input Current Limit

Pin Descriptions

Pin #	Symbol	Function
1, 6, 15	GND	Analog ground pin.
2, 3	SW	Switching node pin. Connect the output inductor to this pin.
4, 5	PGND	Power ground pin for the step-down converter.
7	SYSIN	System input power. P-channel MOSFET source. Connect a 1 μ F capacitor from SYSIN to GND.
8	$\overline{\text{EN}}\text{SYS}$	Enable input for system power load switch. Active Low.
9	SET	Input current limit set input. A resistor from SET to ground sets the current limit for the input load switch.
10, 11	SYSOUT	System output power. P-channel MOSFET drain.
12	ENBUCK	Enable input for step-down converter. Active high. Connect to PVIN when enabling the step-down converter. Do not leave ENBUCK floating.
13	PVIN	Power supply input pin for step-down converter. Must be closely decoupled to PGND with a 22 μ F or greater ceramic capacitor.
14	SVIN	Analog supply input pin. Provides bias for internal circuitry. Connect to PVIN.
16	FB	Feedback pin for step-down converter. Connect FB to the center point of the external resistor divider. The feedback threshold voltage is 0.6V.
	EP	Exposed pad. Must be connected to bare copper ground plane.

Pin Configuration

TDFN34-16
(Top View)

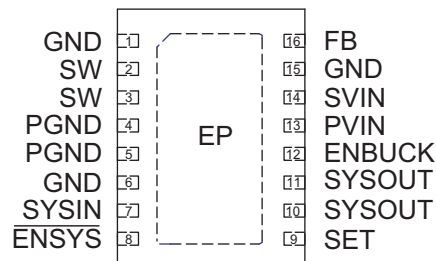

2A Step-Down Converter with Adjustable Input Current Limit

Absolute Maximum Ratings¹

T_A = 25°C unless otherwise noted.

Symbol	Description	Value	Units
V _{IN}	SYSIN, PVIN, SVIN to GND	-0.3 to 6.0	V
V _{GND}	PGND, GND	-0.3 to 6.0	V
V _{SW} , V _{FB}	SW, FB to GND	-0.3 to V _{IN} + 0.3	V
V _{SET} , V _{OUT}	SET, SYSOUT to GND	-0.3 to V _{IN} + 0.3	V
V _{EN}	ENSYS, ENBUCK to GND	-0.3 to V _{IN} + 0.3	V
I _{MAX,SYS}	Maximum Continuous Current for SYSOUT Load Switch	2	A
T _J	Operating Junction Temperature Range	-40 to 150	°C
T _{LEAD}	Maximum Soldering Temperature (at leads, 10 sec)	300	°C

Thermal Characteristics

Symbol	Description	Value	Units
Θ _{JA}	Maximum Thermal Resistance	68.86	°C/W
P _D	Maximum Power Dissipation ^{2, 3}	1.45	W

1. Stresses above those listed in Absolute Maximum Ratings may cause permanent damage to the device. Functional operation at conditions other than the operating conditions specified is not implied. Only one Absolute Maximum Rating should be applied at any one time.
 2. Mounted on an FR4 board.
 3. Derate 20mW/°C above 25°C.

2A Step-Down Converter with Adjustable Input Current Limit

Electrical Characteristics¹

$V_{PVIN} = V_{SVIN} = 3.6V$, $T_A = -40^{\circ}C$ to $85^{\circ}C$ unless otherwise noted. Typical values are at $T_A = 25^{\circ}C$.

Symbol	Description	Conditions	Min	Typ	Max	Units
V_{SYSIN}	Input Voltage		2.5		5.5	V
T_{SD}	Over-Temperature Threshold	$V_{SYSIN} = 5V$, T_J Increasing		135		$^{\circ}C$
		$V_{SYSIN} = 5V$, T_J Decreasing		105		
Step-Down Converter						
V_{OUT}	Output Voltage Range		0.6		V_{PVIN}	V
I_Q	Input DC Supply Current	Active Mode: $V_{FB} = 0.5V$		300	500	μA
		Shutdown Mode: $V_{EN} = 0V$, $V_{PVIN} = 5.5V$		0.1	1	μA
I_{FB}	Feedback Input Bias Current	$V_{FB} = 0.65V$			30	nA
V_{FB_ACC}	Feedback Voltage Accuracy ²	$I_{LOAD} = 10mA$, $T_A = 25^{\circ}C$	0.588	0.60	0.612	V
		No load, $-40^{\circ}C \leq T_A$	0.582	0.60	0.618	
V_{FB_TOL}	Feedback Voltage Tolerance	$V_{PVIN} = 2.5V$ to $5.5V$, 10mA to 2.0A Load	-3.0		+3.0	%
$\Delta V_{LINEREG}/\Delta V_{IN}$	Line Regulation	$V_{PVIN} = 2.5V$ to $5.5V$, 10mA Load, $T_A = 25^{\circ}C$		0.10	0.20	%/V
$\Delta V_{LOADREG}/\Delta I_{OUT}$	Load Regulation	$I_{LOAD} = 0A$ to $2A$		0.2		%/A
I_{LIM}	Current Limit		2.5	3.5		A
$R_{DS(ON)H}$	High Side Switch on Resistance	$V_{PVIN} = 3.6V$		135	200	$m\Omega$
$R_{DS(ON)L}$	Low Side Switch on Resistance	$V_{PVIN} = 3.6V$		95	150	$m\Omega$
F_{OSC}	Oscillator Frequency	$V_{FB} = 0.6V$	0.96	1.2	1.44	MHz
T_S	Startup Time	Enable to output regulation		1.3		ms
V_{IL}	ENBUCK Threshold Low				0.3	V
V_{IH}	ENBUCK Threshold High		1.5			V
I_{LEAK}	ENBUCK Leakage Current	$V_{EN} = 5.5V$	-1.0		1.0	μA
Load Switch						
I_Q	Quiescent Current	$\overline{ENSYS} = GND$, No Load		9	25	μA
$I_{Q(OFF)}$	Off Supply Current	$\overline{ENSYS} = 5V$			1	μA
$I_{SD(OFF)}$	Off Switch Current	$\overline{ENSYS} = 5V$, $V_{SYSIN} = 5V$, $V_{SYSOUT} = 0V$		0.01	1	μA
V_{UVLO}	Under-Voltage Lockout	Rising Edge, 1% Hysteresis		1.8	2.4	V
$R_{DS(ON)}$	On Resistance	$V_{SYSIN} = 5.0V$, $T_A = 25^{\circ}C$		145	180	$m\Omega$
		$V_{SYSIN} = 4.5V$, $T_A = 25^{\circ}C$		150		
		$V_{SYSIN} = 3.0V$, $T_A = 25^{\circ}C$		190	230	
T_{CRDS}	On Resistance Temperature Coefficient			2800		ppm/ $^{\circ}C$
I_{LIM}	Current Limit	$R_{SET} = 6.8k\Omega$	0.75	1	1.25	A
$I_{LIM(MIN)}$	Minimum Current Limit			130		mA
$V_{ENSYS(L)}$	\overline{ENSYS} Input Low Voltage	$V_{SYSIN} = 2.7V$ to $5.5V$			0.8	V
$V_{ENSYS(H)}$	\overline{ENSYS} Input High Voltage	$V_{SYSIN} = 2.7V$ to $< 4.2V$	2.0			V
		$V_{SYSIN} \geq 4.2V$ to $5.0V$	2.4			
$I_{ENSYS(SINK)}$	\overline{ENSYS} Input Leakage	$V_{\overline{ENSYS}} = 5.5V$		0.01	1	μA
T_{RESP}	Current Limit Response Time	$V_{SYSIN} = 5V$		0.4		μs
T_{OFF}	Turn-Off Time	$V_{SYSIN} = 5V$, $R_L = 10\Omega$		4	12	μs
T_{ON}	Turn-On Time	$V_{SYSIN} = 5V$, $R_L = 10\Omega$		24	200	μs

1. The AAT1138 is guaranteed to meet performance specifications over the $-40^{\circ}C$ to $+85^{\circ}C$ operating temperature range and is assured by design, characterization, and correlation with statistical process controls.

2. The regulated feedback voltage is tested in an internal test mode that connects V_{FB} to the output of the error amplifier.

2A Step-Down Converter with Adjustable Input Current Limit

Typical Characteristics

Step-Down Converter Efficiency
($V_{OUT} = 1.8V$; $L = 22\mu H$; $C_{OUT} = C_{SYSOUT} = 22\mu F$)

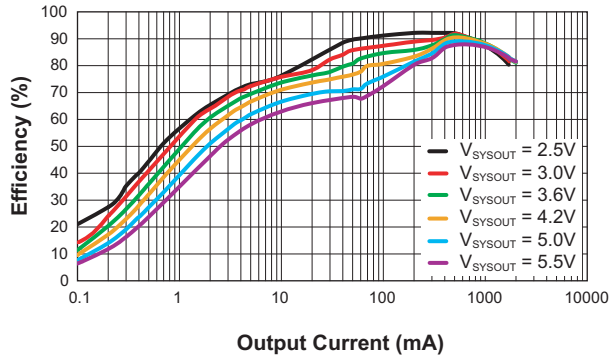

Step-Down Converter Efficiency
($V_{OUT} = 3.3V$; $L = 22\mu H$; $C_{OUT} = C_{SYSOUT} = 22\mu F$)

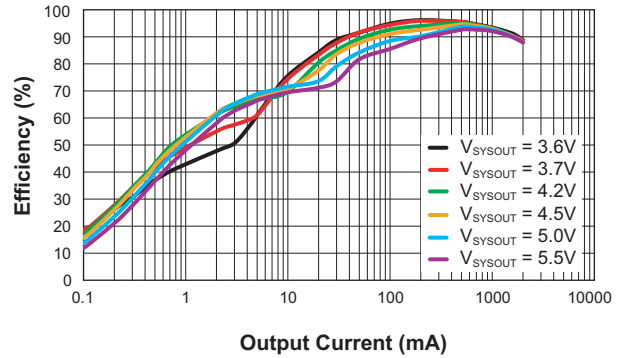

Step-Down Converter Load Regulation
($V_{OUT} = 1.8V$; $L = 22\mu H$; $C_{OUT} = C_{SYSOUT} = 22\mu F$)

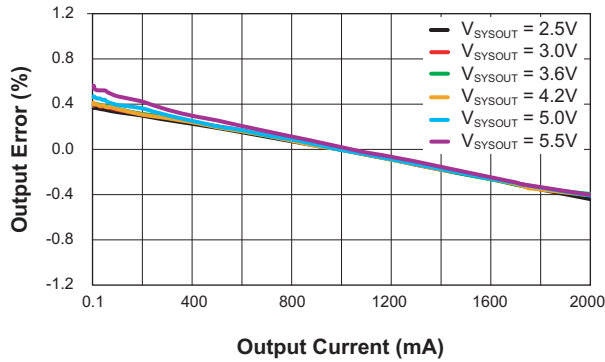

Step-Down Converter Load Regulation
($V_{OUT} = 3.3V$; $L = 22\mu H$; $C_{OUT} = C_{SYSOUT} = 22\mu F$)

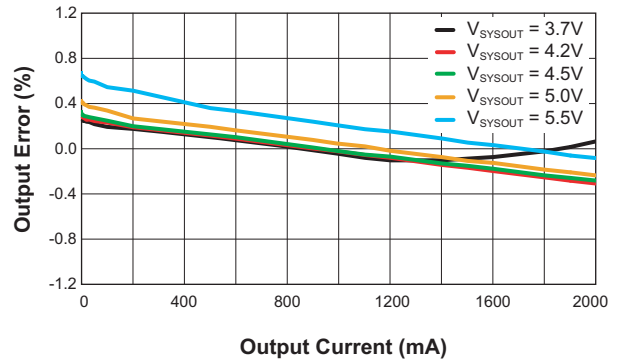

Step-Down Converter Line Regulation vs. Input Voltage
($V_{OUT} = 1.8V$)

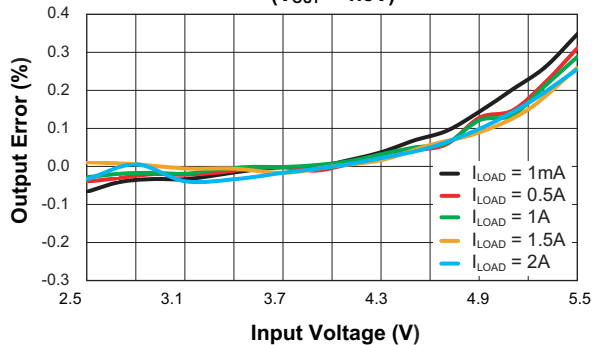

2A Step-Down Converter with Adjustable Input Current Limit

Typical Characteristics

Step-Down Converter Feedback Voltage vs. Temperature
 ($V_{SYSOUT} = 3.6V$)

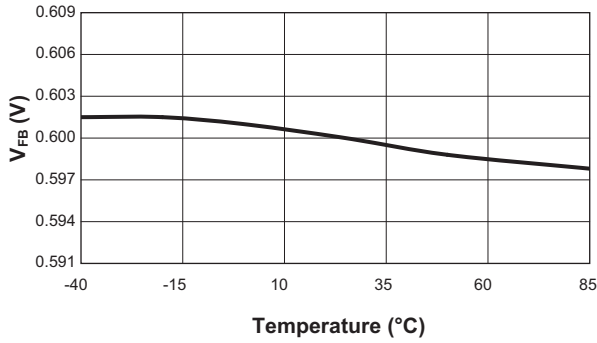

Step-Down Converter Feedback Voltage vs. Input Voltage

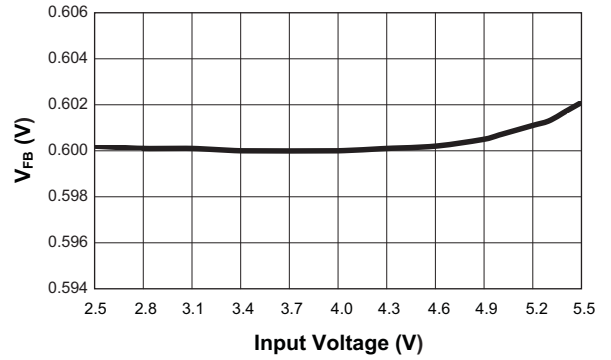

Step-Down Converter V_{ENH} and V_{ENL} vs. Temperature
 ($V_{SYSOUT} = 3.6V$)

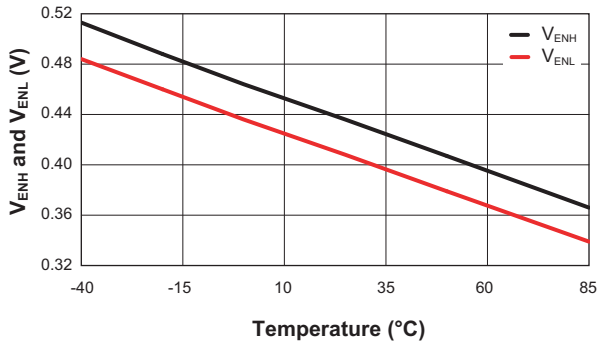

Step-Down Converter V_{ENH} and V_{ENL} vs. Input Voltage

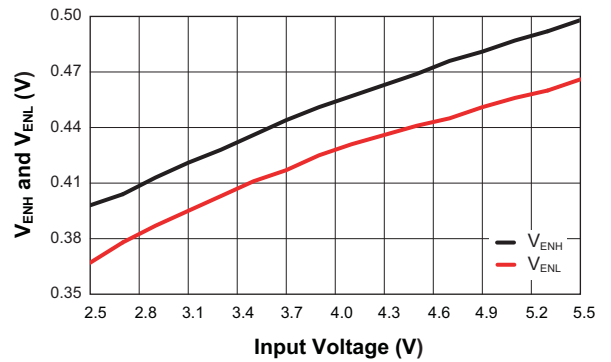

Frequency vs. Temperature

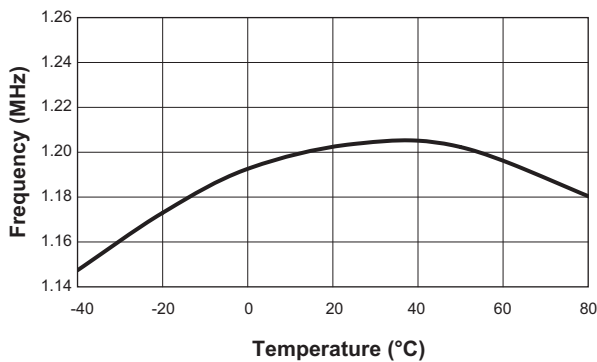

Step-Down Converter EN Leakage vs. Temperature

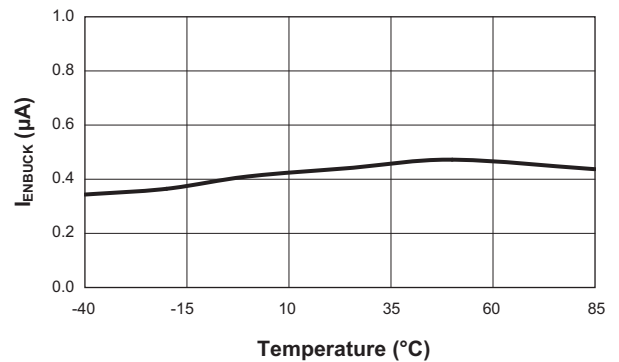

2A Step-Down Converter with Adjustable Input Current Limit

Typical Characteristics

Step-Down Converter P-Channel $R_{DS(ON)}$ vs. Input Voltage

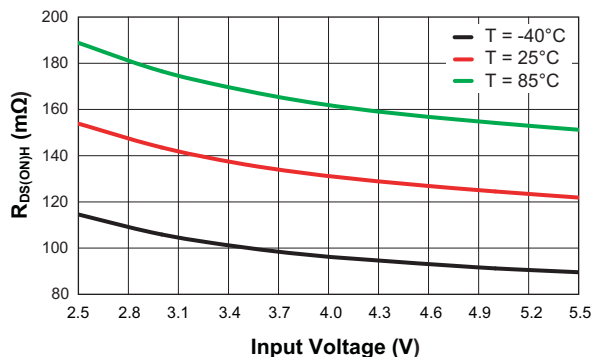

Step-Down Converter N-Channel $R_{DS(ON)}$ vs. Input Voltage

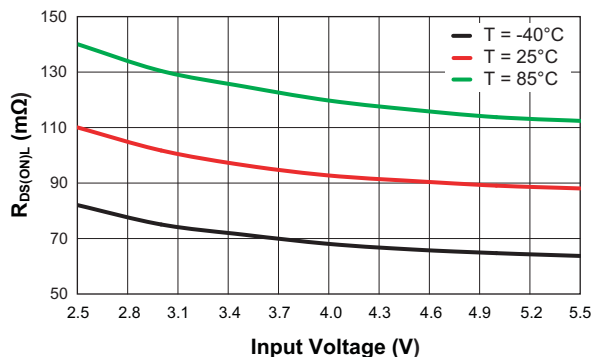

Step-Down Converter Output Ripple
($V_{SYSOUT} = 5.0V$, $V_{OUT} = 1.8V$, $I_{LOAD} = 2A$;
 $C_{SYSOUT} = C_{OUT} = 22\mu F$, $L = 2.2\mu H$)

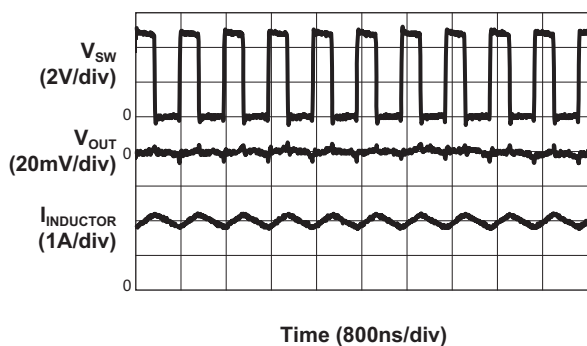

Step-Down Converter Output Ripple
($V_{SYSOUT} = 3.6V$, $V_{OUT} = 1.8V$, $I_{LOAD} = 10mA$;
 $C_{SYSOUT} = C_{OUT} = 22\mu F$, $L = 2.2\mu H$)

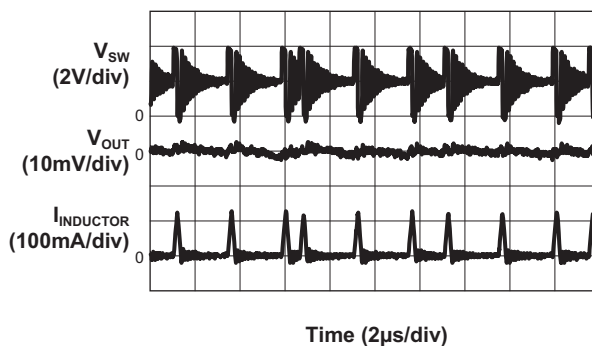

Step-Down Converter Output Ripple
($V_{SYSOUT} = 5.0V$, $V_{OUT} = 3.3V$, $I_{LOAD} = 2A$;
 $C_{SYSOUT} = C_{OUT} = 22\mu F$, $L = 2.2\mu H$)

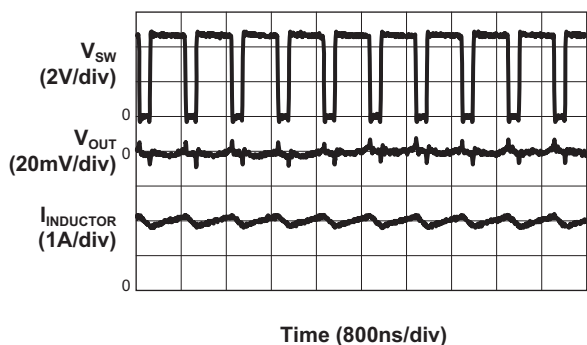

Step-Down Converter Output Ripple
($V_{SYSOUT} = 5.0V$, $V_{OUT} = 3.3V$, $I_{LOAD} = 10mA$;
 $C_{SYSOUT} = C_{OUT} = 22\mu F$, $L = 2.2\mu H$)

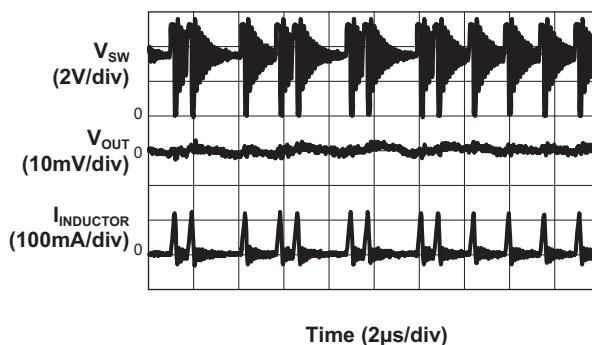

2A Step-Down Converter with Adjustable Input Current Limit

Typical Characteristics

Step-Down Converter Output Ripple

($V_{SYSOUT} = 5.0V$, $V_{OUT} = 3.8V$, $I_{LOAD} = 2A$;
 $C_{SYSOUT} = C_{OUT} = 22\mu F$, $L = 2.2\mu H$)

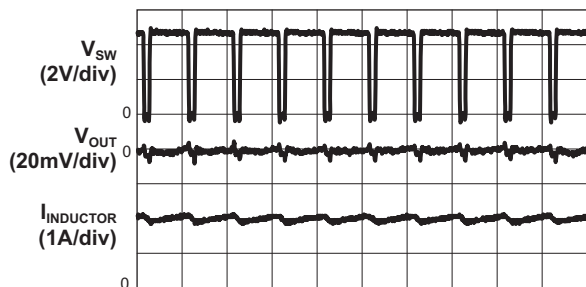

Time (800ns/div)

Step-Down Converter Output Ripple

($V_{SYSOUT} = 5.0V$, $V_{OUT} = 3.8V$, $I_{LOAD} = 10mA$;
 $C_{SYSOUT} = C_{OUT} = 22\mu F$, $L = 2.2\mu H$)

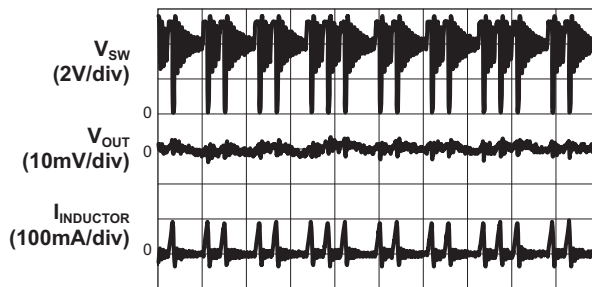

Time (2µs/div)

Step-Down Converter Load Transient

(10mA to 2A; $V_{SYSOUT} = 3.6V$, $V_{OUT} = 1.8V$;
 $C_{OUT} = 22\mu F$, $C_{FF} = 100pF$, $L = 2.2\mu H$)

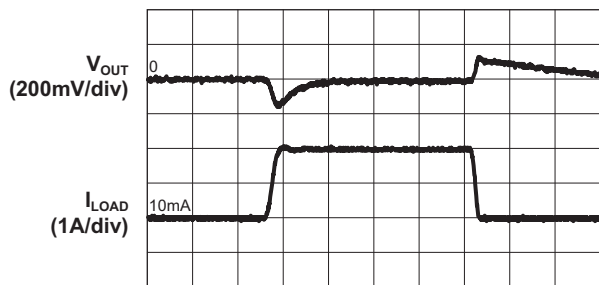

Time (40µs/div)

Step-Down Converter Load Transient

(10mA to 2A; $V_{SYSOUT} = 5.0V$, $V_{OUT} = 3.3V$;
 $C_{OUT} = 22\mu F$, $C_{FF} = 100pF$, $L = 2.2\mu H$)

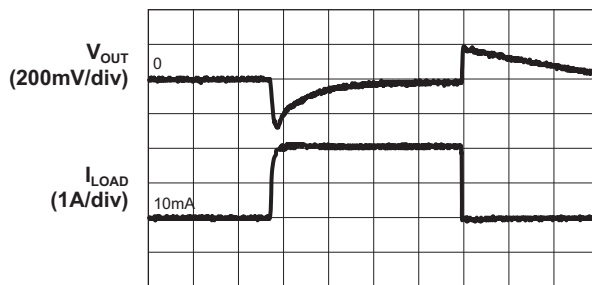

Time (40µs/div)

Step-Down Converter Line Transient

($V_{SYSOUT} = 3.6V$ to $4.2V$; $V_{OUT} = 1.8V$; $I_{LOAD} = 2A$;
 $C_{OUT} = 22\mu F$, $C_{FF} = 100pF$, $L = 2.2\mu H$)

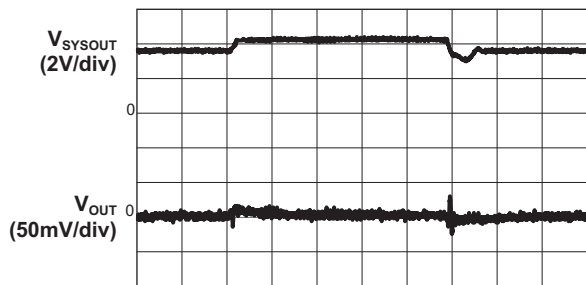

Time (100µs/div)

Step-Down Converter Line Transient

($V_{SYSOUT} = 4.5V$ to $5.0V$; $V_{OUT} = 3.3V$; $I_{LOAD} = 2A$;
 $C_{OUT} = 22\mu F$, $C_{FF} = 100pF$, $L = 2.2\mu H$)

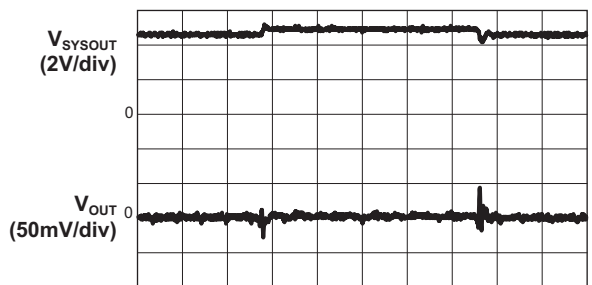

Time (100µs/div)

2A Step-Down Converter with Adjustable Input Current Limit

Typical Characteristics

Step-Down Converter Start-Up Sequence

($V_{SYSOUT} = 3.6V$; $V_{OUT} = 1.8V$; $I_{LOAD} = 2A$,
 $C_{SYSOUT} = C_{OUT} = 22\mu F$, $L = 2.2\mu H$)

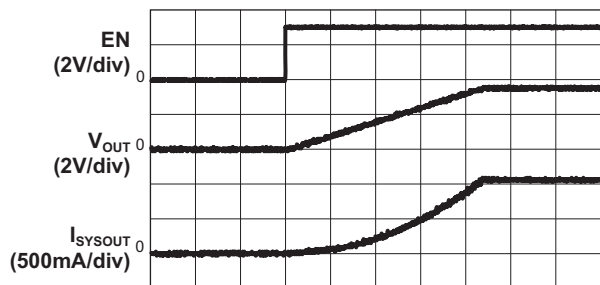

Time (400 μ s/div)

Step-Down Converter Start-Up Sequence

($V_{SYSOUT} = 5.0V$; $V_{OUT} = 3.3V$; $I_{LOAD} = 2A$,
 $C_{SYSOUT} = C_{OUT} = 22\mu F$, $L = 2.2\mu H$)

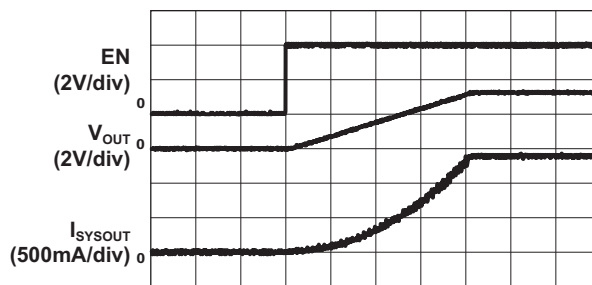

Time (400 μ s/div)

Quiescent Current vs. Input Voltage

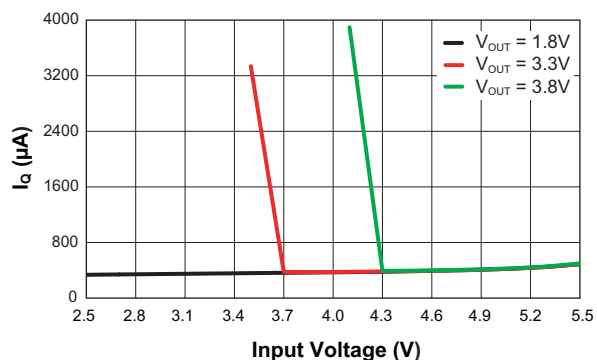

Quiescent Current vs. Temperature ($V_{IN} = 5.0V$)

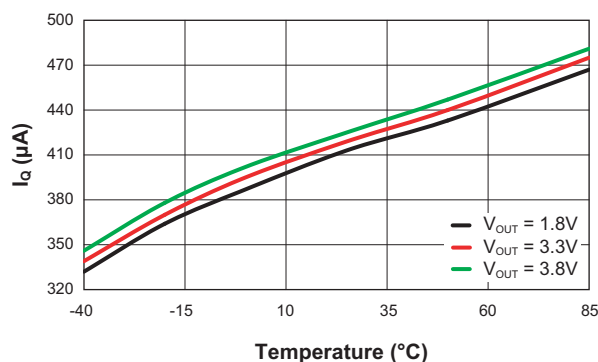

Shutdown Current vs. Temperature

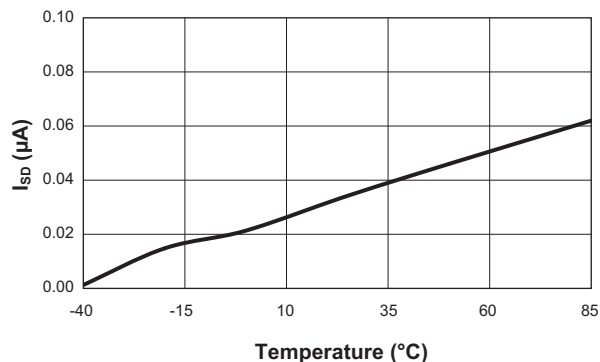

2A Step-Down Converter with Adjustable Input Current Limit

Typical Characteristics

Switch Turn On
 $(V_{IN} = 5V; R_L = 10\Omega; C_{SYSOUT} = 22\mu F)$

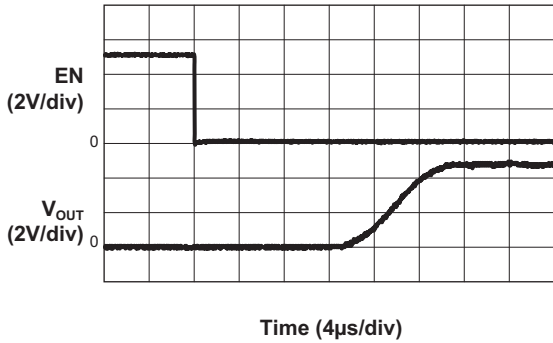

Switch Turn Off
 $(V_{IN} = 5V; R_L = 10\Omega; C_{SYSOUT} = 22\mu F)$

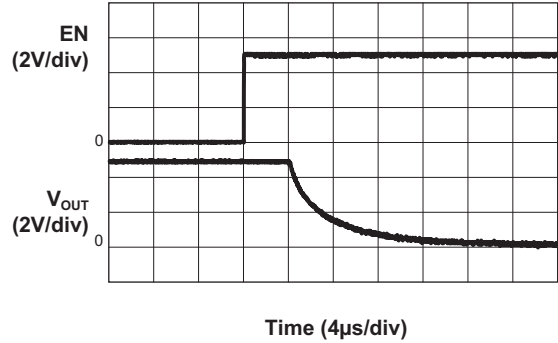

Switch Short Circuit Response
 $(V_{IN} = 5V; R_{LOAD} = 0.3\Omega)$

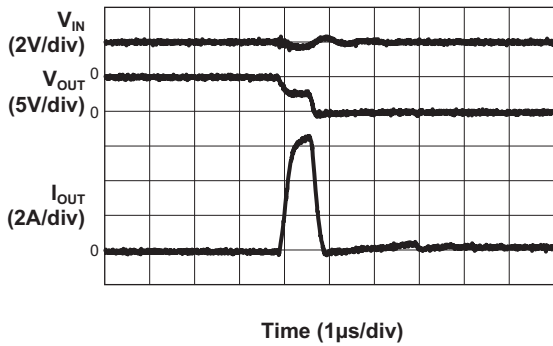

Switch R_{SET} vs. I_{LIM}
 $(V_{IN} = 5.0V; V_{IN} - V_{OUT} = 0.5V)$

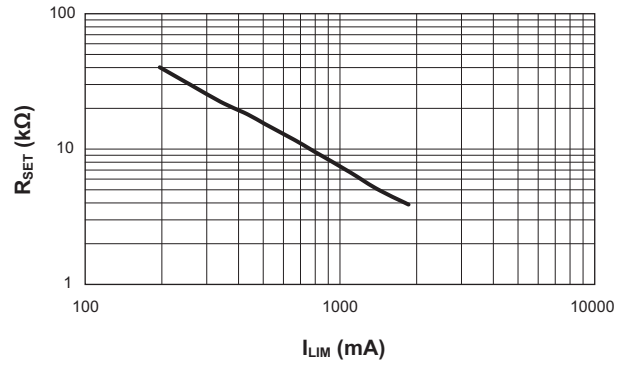

Switch Current Limit vs. Temperature
 $(V_{IN} = 5.0V; R_{SET} = 11.3K\Omega)$

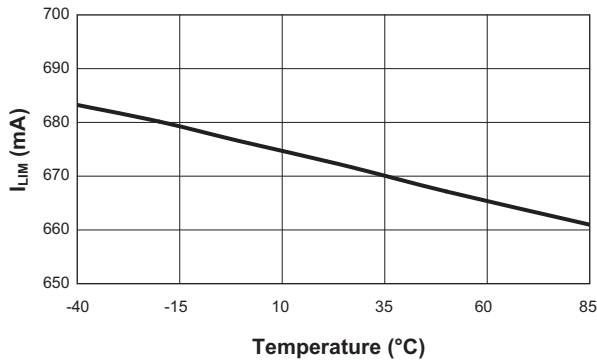

Switch $R_{DS(ON)}$ vs. Input Voltage

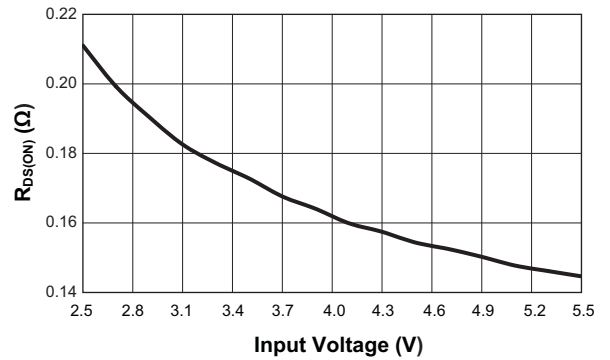

2A Step-Down Converter with Adjustable Input Current Limit

Typical Characteristics

Switch $V_{EN(H)}$ and $V_{EN(L)}$ vs. Input Voltage

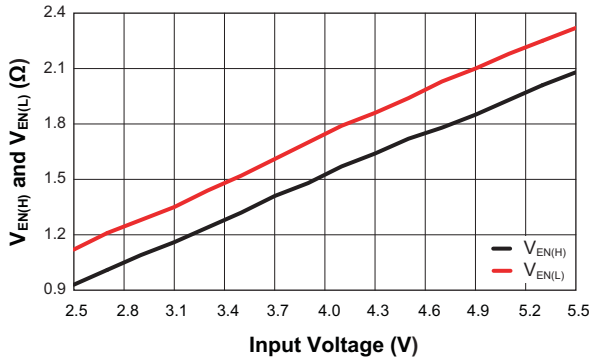

Switch V_{ENH} and V_{ENL} vs. Temperature
($V_{IN} = 5.0V$; $R_{SET} = 11.3K\Omega$)

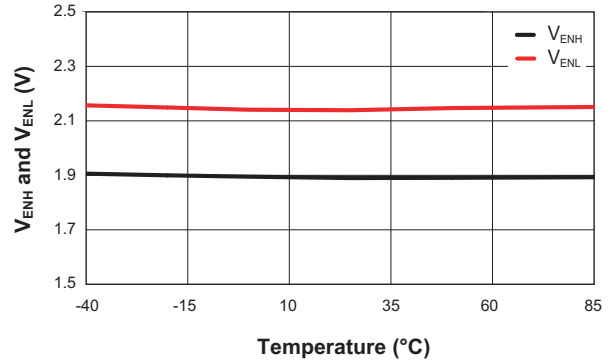

Switch EN Leakage vs. Temperature

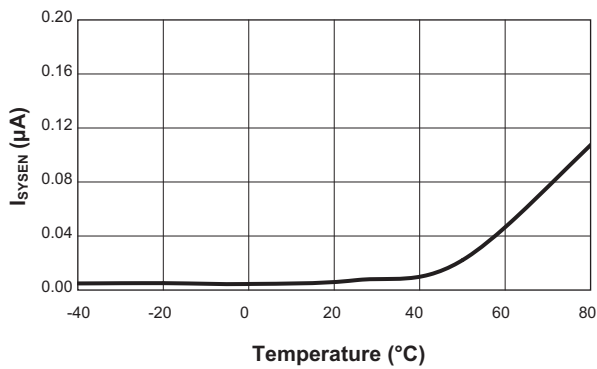

2A Step-Down Converter with Adjustable Input Current Limit

Functional Block Diagram

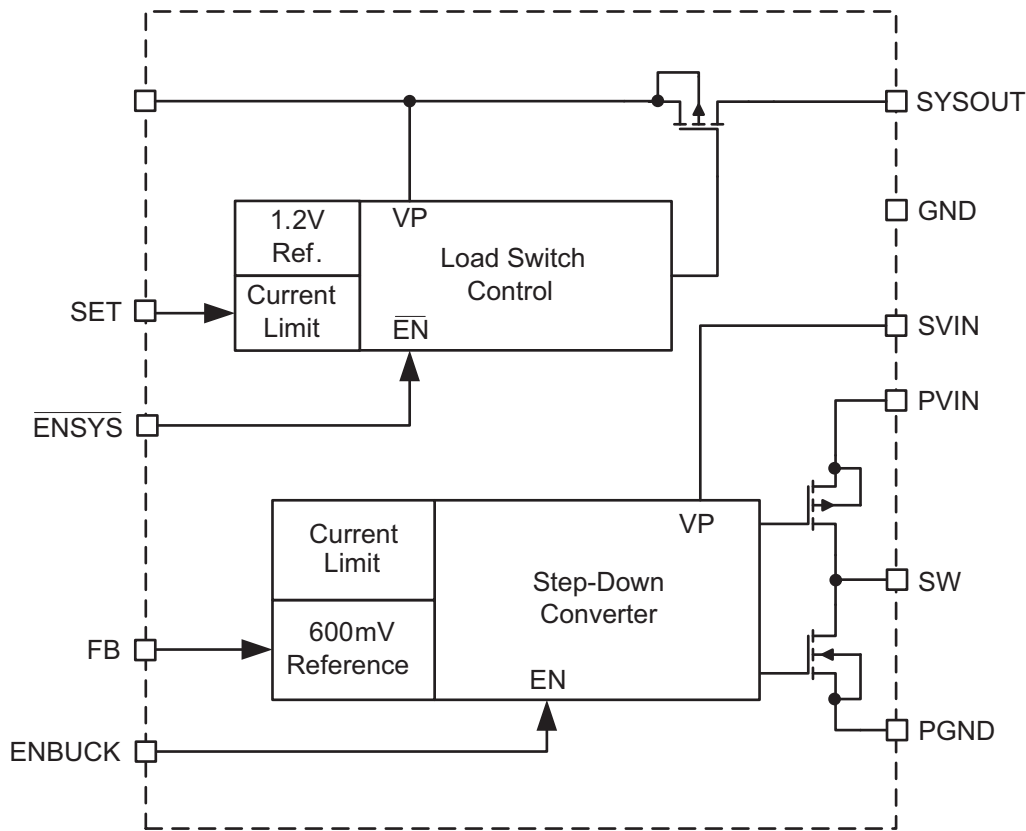

Functional Description

The AAT1138 is a high performance 2A 1.2MHz synchronous step-down converter with a programmable current limited P-channel load switch. It is designed with the goal of high performance with precise input current control under up to 2A load pulse on the step-down converter output.

The P-channel load switch is adopted to limit the system input current. The current limit value is programmed by external resistor between SET and GND. Its fast transient response time make it protect the system input power ideally.

The 2A step-down converter employs internal error amplifier and compensation. It provides excellent transient response, load and line regulation. Its output voltage is programmed by an external resistor divider from 0.6V to converter input voltage. Soft start eliminates any output voltage overshoot when the enable or input volt-

age is applied. Dropout mode makes the converter increase the switch duty cycle to 100% and the output voltage tracks the input voltage minus the $R_{DS(ON)}$ drop of the P-channel high-side MOSFET of the converter.

The AAT1138's input voltage range is 2.5V to 5.5V. Two independent enable pins control the load switch and step-down converter separately. The converter efficiency has been optimized for all load conditions, ranging from no load to 2A.

Step-Down Converter Control Loop

The internal DC-DC converter of the AAT1138 is a peak current mode synchronous step-down converter. The current through the P-channel MOSFET (high side) is sensed for current loop control, as well as short circuit and overload protection. A slope compensation signal is added to the sensed current to maintain stability for duty cycles greater than 50%. The peak current mode loop

2A Step-Down Converter with Adjustable Input Current Limit

appears as a voltage-programmed current source in parallel with the output capacitor. The output of the voltage error amplifier programs the current mode loop for the necessary peak switch current to force a constant output voltage for all load and line conditions. Internal loop compensation terminates the transconductance voltage error amplifier output. For fixed voltage versions, the error amplifier reference voltage is internally set to program the converter output voltage. For the adjustable output, the error amplifier reference is fixed at 0.6V.

Current Limit

The AAT1138 includes two kinds of current limit. One is input current limit by the load switch; the other is inductor current limit by the high-side MOSFET current sense loop of the step-down converter. For overload conditions, the input current is limited by R_{SET} and the peak inductor current is limited to 3.5A. To minimize power dissipation and stresses under current limit and short-circuit conditions, step-down converter switching is terminated after entering current limit for a series of pulses. The termination lasts for seven consecutive clock cycles after a current limit has been sensed during a series of four consecutive clock cycles.

Over-Temperature Protection

Thermal protection completely disables load switch and step-down converter switching when internal dissipation becomes excessive. The junction over-temperature threshold is 125°C with 10°C of hysteresis. Once an over-temperature or over-current fault condition is removed, the output voltage automatically recovers.

Enable/Soft Start

AAT1138 has two independent enable pins: \overline{ENSYS} and ENBUCK. When \overline{ENSYS} is pulled high, the current limit load switch is turned off and SYSOUT drops to zero. When ENBUCK is pulled low, the step-down converter is forced into the low-power, no-switching state. Soft start of the step-down converter limits the current surge seen at the input and eliminates output voltage overshoot.

Dropout Operation

When the step-down converter input voltage V_{PVIN} is close to the value of the output voltage, the main switch is allowed to remain on for more than one switching cycle and increases the duty cycle until it reaches 100%. The duty cycle D of a step-down converter is defined as:

$$D = T_{ON} \cdot f_{OSC} \cdot 100\% = \frac{V_{OUT}}{V_{IN}} \cdot 100\%$$

Where T_{ON} is the main switch on time and f_{OSC} is the oscillator frequency 1.2MHz. The output voltage then is the input voltage minus the voltage drop across the main switch and the inductor. At low input supply voltage, the $R_{DS(ON)}$ of the P-channel MOSFET increases, and the efficiency of the converter decreases. Caution must be exercised to ensure the heat dissipated does not exceed the maximum junction temperature of the IC.

2A Step-Down Converter with Adjustable Input Current Limit

Application Information

Setting the Load Switch Current Limit

The AAT1138's load switch current limit can be programmed by an external resistor R_{SET} from SET to GND. In most applications, the variation in I_{LIM} must be taken into account when determining R_{SET} . The I_{LIM} variation is due to processing variations from part to part, as well as variations in the voltages at SYSIN and SYSOUT, plus the operating temperature. Together, these three factors add up to a $\pm 25\%$ tolerance (see load switch I_{LIM} specification in Electrical Characteristics section). Figure 1 illustrates a cold device with a statistically higher current limit and a hot device with a statistically lower current limit, both with R_{SET} equal to 10.3k Ω . A 10.3k Ω R_{SET} resistor sets the typical current limit to 0.665A. This figure shows that the actual current limit will be at least 0.5A and no greater than 0.83A.

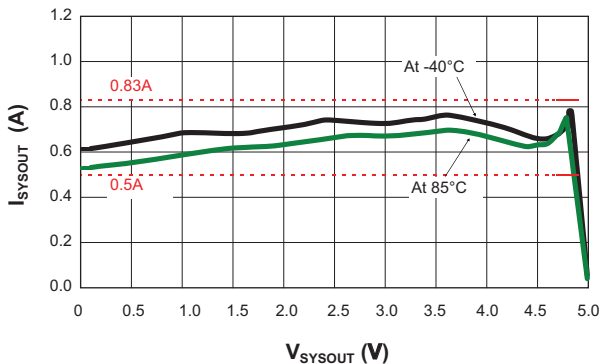

Figure 1: Load Switch Current Limit ($R_{SET} = 10.3k\Omega$).

Though the relationship between typical I_{LIM} and R_{SET} is not linear throughout the current limit setting range, there is constant coefficient between them within a small enough current limit range for the system designer to select a suitable R_{SET} value. Table 1 shows the current limit range using a standard 1% metal film resistor. To determine R_{SET} , start with the maximum allowable input current from SYSIN as minimum I_{LIM} and multiply by 1.33 to derive the typical I_{LIM} value. Next, refer to Table 1 to find the constant coefficient I_{LIM} range which includes the calculated I_{LIM} value and get the constant coefficient value c . Then calculate the R_{SET} by the following formula:

$$R_{SET} = R_{SET_Max} - (I_{LIM} - I_{LIM_Range_Low}) \cdot c$$

R_{SET_Max} is the maximum standard R_{SET} resistance at the certain constant coefficient current limit range.

I_{LIM} is the calculated typical current limit.

$I_{LIM_Range_Low}$ is the low terminal of the current limit range.

c is the coefficient of the current limit range.

Example: Select R_{SET} for 500mA current limit.

The typical current limit is $I_{LIM} = 500 \cdot 1.33 = 665mA$. The constant coefficient current range is 600mA to 700mA and $c = 25000$. Therefore:

$$R_{SET} = 13k\Omega - (665mA - 600mA) \cdot 25000 = 11.375k\Omega$$

Select a standard 11.3k Ω resistor for R_{SET} . Considering the $\pm 25\%$ tolerance, the current limit will be greater than 500mA but less than 831mA.

I_{LIM} Typ. (mA)	Constant Coefficient c of R_{SET} / I_{LIM}	1% Standard R_{SET} (k Ω)
200	186000	40.2
250	120000	30.9
300	56000	24.9
350	50000	22.1
400	36000	19.6
450	32000	17.8
500	30000	16.2
550	34000	14.7
600	25000	13.0
700	16300	10.5
800	13700	8.87
900	6900	7.50
1000	7700	6.81
1100	5500	6.04
1200	5000	5.49
1300	3500	4.99
1400		4.64

Table 1: Current Limit R_{SET} Values.

Dropout Voltage

Dropout voltage is determined by $R_{DS(ON)}$ and the current passing through it. AAT1138 load switch maximum $R_{DS(ON)}$ is 180m Ω for USB applications and the step-down converter high side $R_{DS(ON)}$ is maximum 200m Ω . So for a 500mA load switch current limit setting (the load switch always limits below 831mA as described above), the load switch maximum dropout voltage can be calculated by:

$$V_{Dropout_Switch} = 831mA \cdot 180m\Omega = 0.15V$$

2A Step-Down Converter with Adjustable Input Current Limit

To 2A step-down converter, the maximum dropout voltage is:

$$V_{\text{Dropout_Buck}} = 2\text{A} \cdot 200\text{m}\Omega = 0.4\text{V}$$

Operation in Heavy Load Pulse

When a heavy load pulse is applied to the output of AAT1138 as typical application shows, the input current is limited to the value of I_{LIM} determined by R_{SET} . At this time, C_{SYSOUT} has the important role of providing enough current and voltage to the step-down converter input to bring it into regulation. The duty cycle of the heavy load pulse should not exceed the maximum value which allows sufficient time to charge C_{SYSOUT} from V_{IN} and balance the capacitor charging and discharging to make the operation normally. Figure 2 shows the operation waveform at 5V V_{IN} and 3.8V V_{OUT} with a 2A load pulse applied when $R_{\text{SET}} = 11.5\text{k}\Omega$, $C_{\text{IN}} = 1\mu\text{F}$, $C_{\text{SYSOUT}} = 22\mu\text{F}$ ceramic capacitor + 4x330 μF tantalum capacitor, and $C_{\text{OUTB}} = 22\mu\text{F}$.

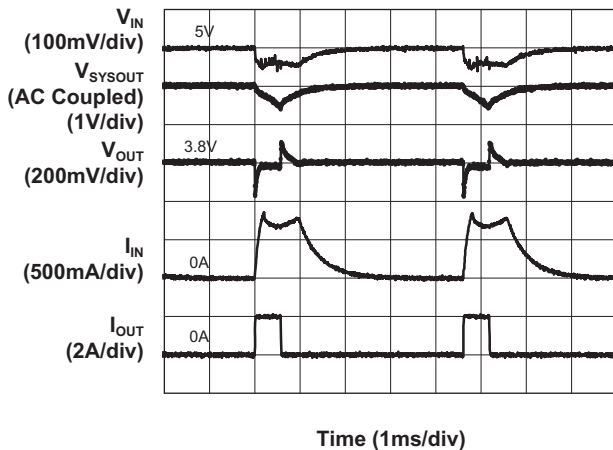

Figure 2: AAT1138 Operation Waveform when 2A 217Hz 12.5% Load Pulse is Applied.

Capacitor Selection

C_{SYSOUT} Selection

C_{SYSOUT} is not only the load switch output capacitor but also the step-down converter input capacitor. It is designed to provide the additional input current and maintain the SYSOUT voltage for the step-down converter when load switch limits the input current from SYSIN. If the input voltage of the step-down converter (V_{PVIN} and V_{SVIN}) is lower than the V_{OUT} plus the dropout voltage, the AAT1138 enters dropout mode.

C_{SYSOUT} minimum value can be calculated by the following steps:

First, calculate the allowed maximum delta voltage on C_{SYSOUT} to keep V_{out} in regulation:

$$\Delta V_{\text{SYSOUT}} = V_{\text{IN}} - V_{\text{OUT}} - V_{\text{Dropout_Switch}} - V_{\text{Dropout_Buck}}$$

Second, calculate the required input current at SYSOUT for the step-down converter:

$$I_{\text{BUCKIN}} = \frac{V_{\text{OUT}} \cdot I_{\text{OUT}}}{(V_{\text{IN}} - V_{\text{Dropout_Switch}}) \cdot \eta}$$

Next, calculate the maximum current C_{SYSOUT} should provide:

$$I_{\text{CSYSOUT}} = I_{\text{BUCKIN}} - I_{\text{LIM}}$$

Finally, derive the C_{SYSOUT} at certain load on period T_{ON} .

$$C_{\text{SYSOUT_Min}} = \frac{I_{\text{CSYSOUT}} \cdot T_{\text{ON}}}{\Delta V_{\text{SYSOUT}}}$$

Example: A 2A 217Hz 12.5% load pulse is applied on 3.8V V_{OUT} in 5V V_{IN} and 500mA load switch current limit. Under the condition, $V_{\text{Dropout_Switch}}$ is 0.15V. $V_{\text{Dropout_Buck}}$ is 0.4V. Therefore:

$$\Delta V_{\text{SYSOUT}} = 5 - 3.8 - 0.15 - 0.4 = 0.65\text{V}$$

2A Step-Down Converter with Adjustable Input Current Limit

Considering the step-down converter at 2A 3.8V V_{OUT} is 90%.

$$I_{BUCKIN} = \frac{3.8 \cdot 2}{(5 - 0.15) \cdot 90\%} = 1.74A$$

$$I_{CSYSOUT} = 1.74 - 0.5 = 1.24A$$

T_{ON} is 576 μ s for a 217Hz 12.5% duty cycle load pulse.

$$C_{SYSOUT_Min} = \frac{1.24A \cdot 576\mu s}{0.65V} = 1099\mu F$$

Considering 20% capacitance tolerance, the minimum capacitance should be 1319 μ F. So select 4x330 μ F tantalum capacitor as C_{SYSOUT} , as well as an additional 22 μ F ceramic capacitor to closely filter the input voltage V_{SYSOUT} of the step-down converter on the PCB board.

C_{OUTB} Selection

The value of output capacitance is generally selected to limit output voltage ripple to the level required by the specification. Since the ripple current in the output inductor is usually determined by L , V_{OUT} and V_{IN} , the series impedance of the capacitor primarily determines the output voltage ripple. The three elements of the capacitor that contribute to its impedance (and output voltage ripple) are equivalent series resistance (ESR), equivalent series inductance (ESL), and capacitance (C). The formula below gives the general output voltage ripple calculation:

$$\Delta V_{OUT} \leq \frac{V_{OUT} \cdot (V_{IN} - V_{OUT})}{V_{IN} \cdot f_{OSC} \cdot L} \cdot \left(ESR + \frac{1}{8 \cdot f_{OSC} \cdot C_{OUT}} \right)$$

The output voltage droop due to a load transient is dominated by the capacitance of the output capacitor. During a step increase in load current, the output capacitor alone supplies the load current until the loop responds. Within three switching cycles, the loop responds and the inductor current increases to match the load current demand. The relationship of the output voltage droop during the three switching cycles to the output capacitance can be estimated by:

$$C_{OUT} = \frac{3 \cdot \Delta I_{LOAD}}{V_{DROOP} \cdot F_{OSC}}$$

In many practical designs, to get the required ESR, a capacitor with much more capacitance than is needed must be selected.

For both continuous and discontinuous inductor current mode operation, the ESR of the C_{OUT} needed to limit the ripple to ΔV_O , V peak-to-peak is:

$$ESR \leq \frac{\Delta V_O}{\Delta I_L}$$

ESL can be a problem by causing ringing in the low megahertz region but can be controlled by choosing low ESL capacitors, limiting lead length (PCB and capacitor), and replacing one large device with several smaller ones connected in parallel.

In conclusion, in order to meet the requirement of low output voltage ripple and regulation loop stability, ceramic capacitors with X5R or X7R dielectrics are recommended due to their low ESR and high ripple current ratings. A 22 μ F ceramic capacitor can satisfy most applications.

Inductor Selection

For most designs, the AAT1138 operates with inductor values of 2.0 μ H to 6.8 μ H. Inductors with low inductance values are physically smaller but generate higher inductor current ripple leading to higher output voltage ripple. Refer to the "Capacitor Selection" section of this datasheet for the output ripple calculation. The inductor ripple current can be derived from the following equation:

$$\Delta I_L \leq \frac{V_{OUT} \cdot (V_{IN} - V_{OUT})}{V_{IN} \cdot f_{OSC} \cdot L}$$

Large value inductors lower ripple current and small value inductors result in high ripple currents. Choose inductor ripple current approximately 30% of the maximum load current 2A, or

$$\Delta I_L = 600mA$$

Manufacturer's specifications list both the inductor DC current rating, which is a thermal limitation, and the peak current rating, which is determined by the saturation characteristics. The inductor should not show any appreciable saturation under normal load conditions. The DC current rating of the inductor should be at least equal to the maximum load current plus half the inductor ripple current to prevent core saturation (2A + 300mA).

2A Step-Down Converter with Adjustable Input Current Limit

Manufacturer	Part Number	Value	Voltage	Tolerance	Temp. Co.	ESR (mΩ)	Case
Murata	GRM21BR60J226ME39	22μF	6.3	20%	X5R	26	0805
AVX	TAJD337M006R	330μF	6.3	20%	X5R	400	7343
	TPSD337M006R0150	330μF	6.3	20%	X5R	150	7343
	TAJD477M006R	470μF	6.3	20%	X5R	400	7343
	TPSD477M006R0150	470μF	6.3	20%	X5R	150	7343
	TAJD687M006R	680μF	6.3	20%	X5R	500	7343
	TPSD687M006R0100	680μF	6.3	20%	X5R	100	7343
KEMET	T491D337M006AT	330μF	6.3	20%	X5R	400	7343
	T495D337M006ATE100	330μF	6.3	20%	X5R	100	7343
	T491D477M006AT	470μF	6.3	20%	X5R	400	7343
	T495D477M006ATE150	470μF	6.3	20%	X5R	150	7343
	T491D687M006ZT	680μF	6.3	20%	X5R	500	7343
	T495D687M006ZTE150	680μF	6.3	20%	X5R	150	7343

Table 2: Surface Mount Capacitors.

Manufacturer	Part Number	Inductance (μH)	Saturation Current (A)	DCR Typ. (mΩ)	Size (mm) LxWxH	Type
Sumida	CDRH5D16	2.2	3.0	28.7	5.8x5.8x1.8	Shielded
	CDRH5D16	3.3	2.6	35.6	5.8x5.8x1.8	Shielded
	CDRH8D28	4.7	3.4	19	8.3x8.3x3.0	Shielded
Coiltronics	SD53	2.0	3.3	23	5.2x5.2x3.0	Shielded
	SD53	3.3	2.6	29	5.2x5.2x3.0	Shielded
	SD53	4.7	2.1	39	5.2x5.2x3.0	Shielded

Table 3: Surface Mount Inductors.

Adjustable Output Resistor Selection

For applications requiring an adjustable output voltage, the 0.6V version can be externally programmed. Resistors R1 and R2 of Figure 3 program the output to regulate at a voltage higher than 0.6V. To limit the bias current required for the external feedback resistor string while maintaining good noise immunity, the minimum suggested value for R2 is 59kΩ and the R1+R2 should be less than 1.5MΩ. The external resistor sets the output voltage according to the following equation:

$$V_{OUT} = 0.6 \cdot \left(1 + \frac{R1}{R2} \right)$$

$$R1 = \left(\frac{V_{OUT}}{0.6} - 1 \right) \cdot R2$$

Table 4 summarizes the standard 1% metal film resistor values for various output voltages with R2 set to 59kΩ.

V _{OUT} (V)	R2 = 59kΩ R1 (kΩ)
1.0	39.2
1.2	59.0
1.5	88.7
1.8	118
2.0	137
2.5	187
3.3	267
3.6	294
3.8	316
4.2	357

Table 4: Resistor Selections for Different Output Voltage Settings.

2A Step-Down Converter with Adjustable Input Current Limit

Layout Guidance

When laying out the PC board, the following layout guidelines should be followed to ensure proper operation of the AAT1138:

1. The exposed pad (EP) must be reliably soldered to the GND plane. A GND pad below EP is strongly recommended.
2. The power traces, including the GND trace, the SW trace and the SYSIN, SYSOUT trace should be kept short, direct and wide to allow large current flow. The L1 connection to the SW pins should be as short as possible. Do not put any signal lines under the inductor.
3. The input capacitor (C1 and C21) should connect as closely as possible to SYSIN and SYSOUT and GND to get good power filtering.
4. Keep the switching node, SW away from the sensitive FB node.
5. The feedback trace should be separate from any power trace and connect as closely as possible to the load point. Sensing along a high-current load trace will degrade DC load regulation. External feedback resistors should be placed as closely as possible to the FB pin to minimize the length of the high impedance feedback trace.
6. The resistance of the trace from the load return to GND should be kept to a minimum. This will help to minimize any error in DC regulation due to differences in the potential of the internal signal ground and the power ground.

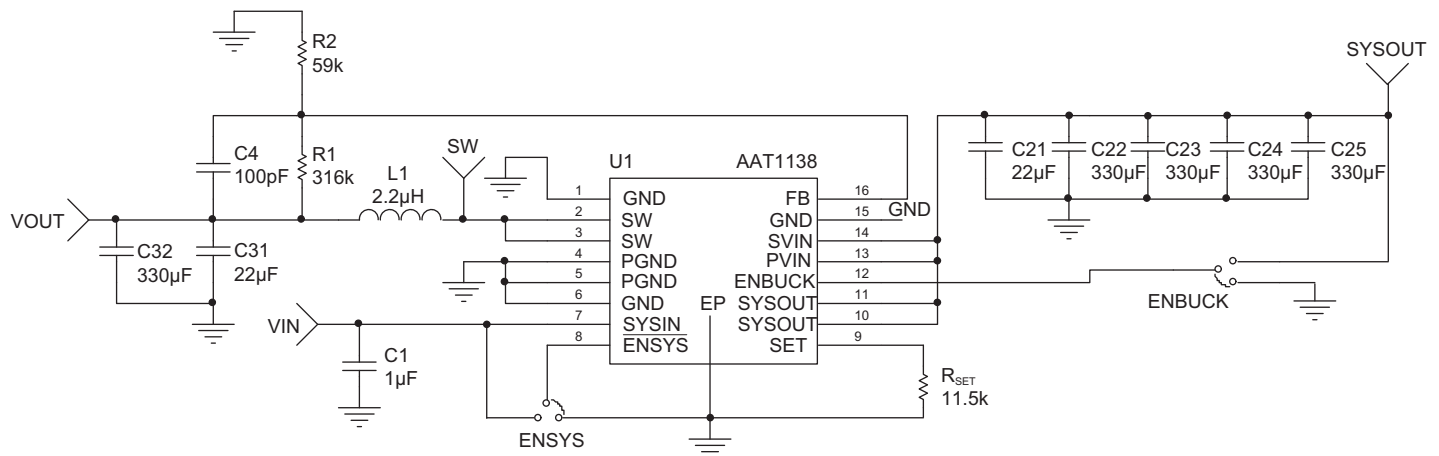

Figure 3: AAT1138 Evaluation Board Schematic.

AAT1138

2A Step-Down Converter with Adjustable Input Current Limit

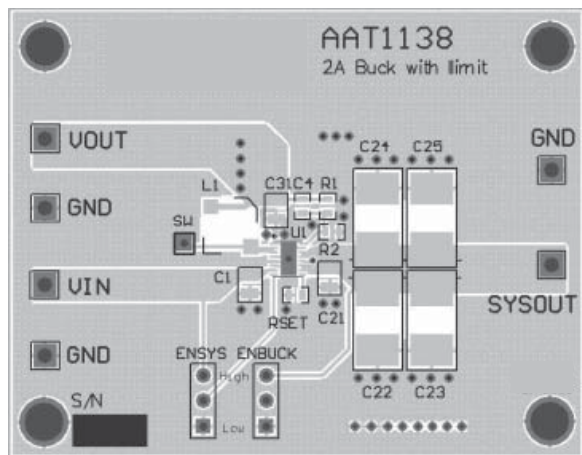

Figure 4: AAT1138 Evaluation Board Layout Top Layer.

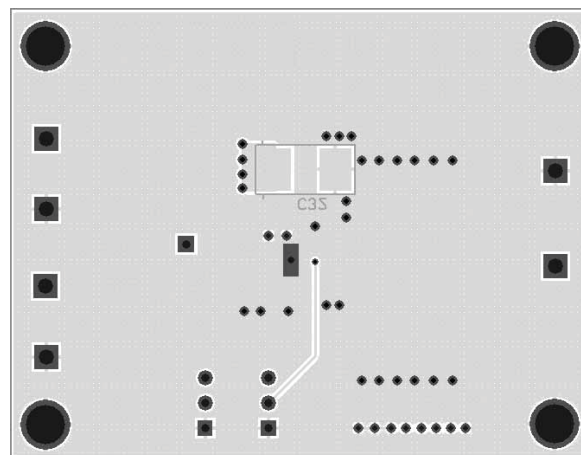

Figure 5: AAT1138 Evaluation Board Layout Bottom Layer.

Designation	Part Number	Description	Manufacturer
U1	AAT1138IRN-0.6-T1	2A Buck with Current Limit	Skyworks
C1	GRM21BR71E105K	CAP Ceramic 1µF 0805 X7R 25V 10%	Murata
C4	GRM1885C1H101J	CAP Ceramic 100pF 0603 COG 50V 5%	
C21, C31	GRM21BR60J226M	CAP Ceramic 22µF 0805 X5R 6.3V 20%	
C22, C23, C24, C25, C32	TPSY337M006R0150	Cap Tan 330µF Y case 6.3V 20%	AVX
L1	CDRH5D16-2R2	Power Inductor 2.2µH 3.0A SMD	Sumida
R1	RC0603FR-07316KL	RES 316KΩ 1/10W 1% 0603 SMD	Yageo
R2	RC0603FR-0759KL	RES 59KΩ 1/10W 1% 0603 SMD	
RSET	RC0603FR-0711K5L	RES 11.5KΩ 1/10W 1% 0603 SMD	

Table 5: AAT1138 Evaluation Board Bill of Materials (BOM).

AAT1138

2A Step-Down Converter with Adjustable Input Current Limit

Ordering Information

Output Voltage	Package	Marking ¹	Part Number (Tape and Reel) ²
Adjustable $\geq 0.6V$	TDFN34-16	7BXY	AAT1138IRN-0.6-T1

 Skyworks Green™ products are compliant with all applicable legislation and are halogen-free. For additional information, refer to *Skyworks Definition of Green™*, document number SQ04-0074.

Package Information

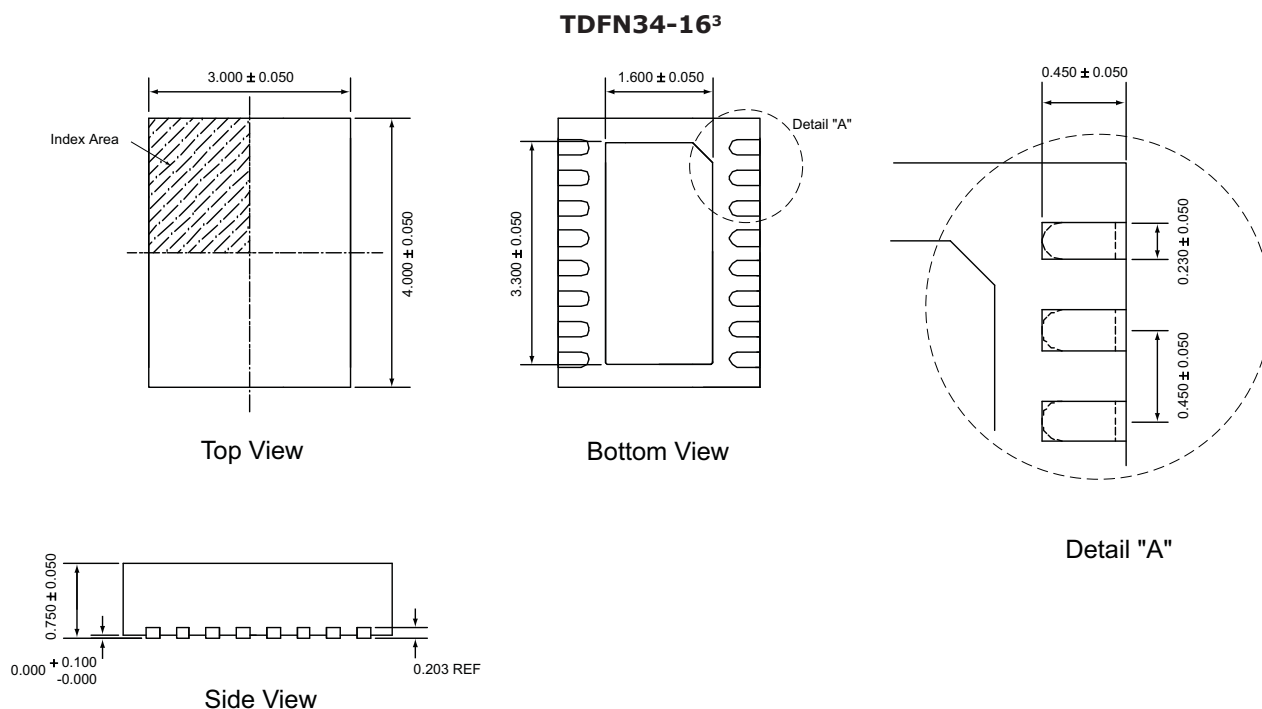

All dimensions in millimeters.

1. XYY = assembly and date code.
 2. Sample stock is generally held on part numbers listed in **BOLD**.
 3. The leadless package family, which includes QFN, TQFN, DFN, TDFN and STDFN, has exposed copper (unplated) at the end of the lead terminals due to the manufacturing process. A solder fillet at the exposed copper edge cannot be guaranteed and is not required to ensure a proper bottom solder connection.

2A Step-Down Converter with Adjustable Input Current Limit

Copyright © 2012, 2013 Skyworks Solutions, Inc. All Rights Reserved.

Information in this document is provided in connection with Skyworks Solutions, Inc. ("Skyworks") products or services. These materials, including the information contained herein, are provided by Skyworks as a service to its customers and may be used for informational purposes only by the customer. Skyworks assumes no responsibility for errors or omissions in these materials or the information contained herein. Skyworks may change its documentation, products, services, specifications or product descriptions at any time, without notice. Skyworks makes no commitment to update the materials or information and shall have no responsibility whatsoever for conflicts, incompatibilities, or other difficulties arising from any future changes.

No license, whether express, implied, by estoppel or otherwise, is granted to any intellectual property rights by this document. Skyworks assumes no liability for any materials, products or information provided hereunder, including the sale, distribution, reproduction or use of Skyworks products, information or materials, except as may be provided in Skyworks Terms and Conditions of Sale.

THE MATERIALS, PRODUCTS AND INFORMATION ARE PROVIDED "AS IS" WITHOUT WARRANTY OF ANY KIND, WHETHER EXPRESS, IMPLIED, STATUTORY, OR OTHERWISE, INCLUDING FITNESS FOR A PARTICULAR PURPOSE OR USE, MERCHANTABILITY, PERFORMANCE, QUALITY OR NON-INFRINGEMENT OF ANY INTELLECTUAL PROPERTY RIGHT; ALL SUCH WARRANTIES ARE HEREBY EXPRESSLY DISCLAIMED. SKYWORKS DOES NOT WARRANT THE ACCURACY OR COMPLETENESS OF THE INFORMATION, TEXT, GRAPHICS OR OTHER ITEMS CONTAINED WITHIN THESE MATERIALS. SKYWORKS SHALL NOT BE LIABLE FOR ANY DAMAGES, INCLUDING BUT NOT LIMITED TO ANY SPECIAL, INDIRECT, INCIDENTAL, STATUTORY, OR CONSEQUENTIAL DAMAGES, INCLUDING WITHOUT LIMITATION, LOST REVENUES OR LOST PROFITS THAT MAY RESULT FROM THE USE OF THE MATERIALS OR INFORMATION, WHETHER OR NOT THE RECIPIENT OF MATERIALS HAS BEEN ADVISED OF THE POSSIBILITY OF SUCH DAMAGE.

Skyworks products are not intended for use in medical, lifesaving or life-sustaining applications, or other equipment in which the failure of the Skyworks products could lead to personal injury, death, physical or environmental damage. Skyworks customers using or selling Skyworks products for use in such applications do so at their own risk and agree to fully indemnify Skyworks for any damages resulting from such improper use or sale.

Customers are responsible for their products and applications using Skyworks products, which may deviate from published specifications as a result of design defects, errors, or operation of products outside of published parameters or design specifications. Customers should include design and operating safeguards to minimize these and other risks. Skyworks assumes no liability for applications assistance, customer product design, or damage to any equipment resulting from the use of Skyworks products outside of stated published specifications or parameters.

Skyworks, the Skyworks symbol, and "Breakthrough Simplicity" are trademarks or registered trademarks of Skyworks Solutions, Inc., in the United States and other countries. Third-party brands and names are for identification purposes only, and are the property of their respective owners. Additional information, including relevant terms and conditions, posted at www.skyworksinc.com, are incorporated by reference.