

Dual IGBTMOD™ NFH-Series Module 200 Amperes/600 Volts

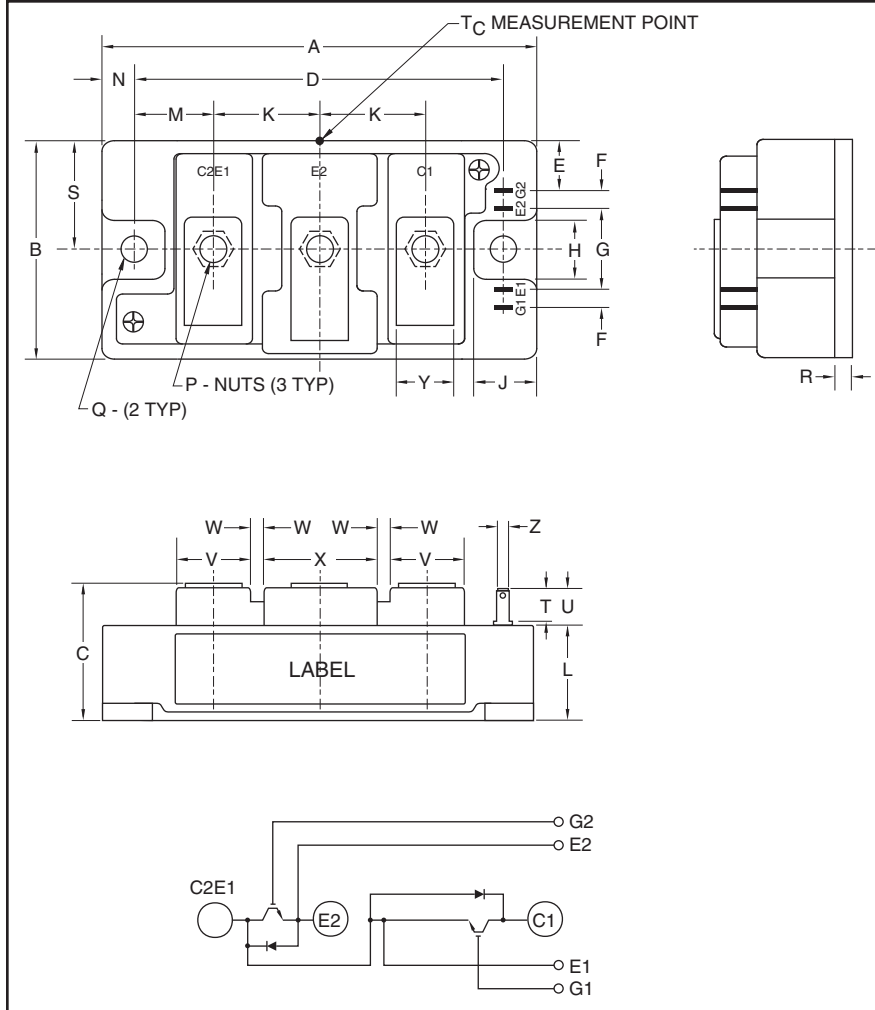

Outline Drawing and Circuit Diagram

Dimensions	Inches	Millimeters
A	3.70	94.0
B	1.89	48.0
C	1.18+0.04/-0.01	30.0+1.0/-0.5
D	3.15±0.01	80.0±0.25
E	0.43	11.0
F	0.16	4.0
G	0.71	18.0
H	0.51	13.0
J	0.53	13.5
K	0.91	23.0
L	0.83	21.2
M	0.67	17.0

Dimensions	Inches	Millimeters
N	0.28	7.0
P	M5 Metric	M5
Q	0.26 Dia.	Dia. 6.5
R	0.02	4.0
S	0.94	24.0
T	0.3	7.5
U	0.33	8.5
V	0.63	16.0
W	0.1	2.5
X	0.98	25.0
Y	0.47	12.0
Z	0.11	2.8

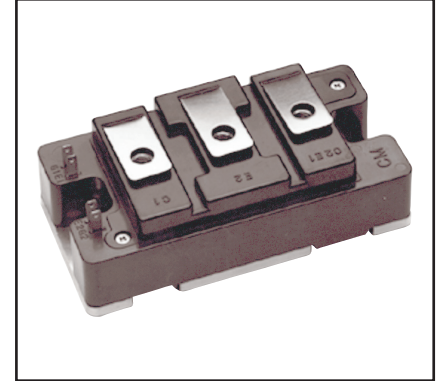

Description:

Powerex IGBTMOD™ Modules are designed for use in high frequency applications; 30 kHz for hard switching applications and 60 to 70 kHz for soft switching applications. Each module consists of two IGBT Transistors in a half-bridge configuration with each transistor having a reverse-connected super-fast recovery free-wheel diode. All components and interconnects are isolated from the heat sinking baseplate, offering simplified system assembly and thermal management.

Features:

- Low $V_{CE(sat)}$
- Low $ESW(off)$
- Discrete Super-Fast Recovery Free-Wheel Diode
- Isolated Baseplate for Easy Heat Sinking

Applications:

- Power Supplies
- Induction Heating
- Welders

Ordering Information:

Example: Select the complete part module number you desire from the table below -i.e.

CM200DU-12NFH is a 600V (V_{CES}), 200 Ampere Dual IGBTMOD™ Power Module.

Type	Current Rating Amperes	V_{CES} Volts (x 50)
CM	200	12



Powerex, Inc., 173 Pavilion Lane, Youngwood, Pennsylvania 15697 (724) 925-7272

CM200DU-12NFH
Dual IGBTMOD™ NFH-Series Module
 200 Amperes/600 Volts

Absolute Maximum Ratings, $T_j = 25\text{ }^\circ\text{C}$ unless otherwise specified

Ratings	Symbol	CM200DU-12NFH	Units
Junction Temperature	T_j	-40 to 150	$^\circ\text{C}$
Storage Temperature	T_{stg}	-40 to 125	$^\circ\text{C}$
Collector-Emitter Voltage (G-E Short)	V_{CES}	600	Volts
Gate-Emitter Voltage (C-E Short)	V_{GES}	± 20	Volts
Collector Current ($T_C = 25^\circ\text{C}$)	I_C	200*	Amperes
Peak Collector Current	I_{CM}	400*	Amperes
Emitter Current** ($T_C = 25^\circ\text{C}$)	I_E	200*	Amperes
Peak Emitter Current**	I_{EM}	400*	Amperes
Maximum Collector Dissipation ($T_C = 25^\circ\text{C}$, $T_j \leq 150^\circ\text{C}$)	P_C	590	Watts
Maximum Collector Dissipation ($T_C = 25^\circ\text{C}$, $T_j \leq 150^\circ\text{C}$)	P_C	830	Watts
Mounting Torque, M5 Main Terminal	—	30	in-lb
Mounting Torque, M6 Mounting	—	40	in-lb
Weight	—	310	Grams
Isolation Voltage (Main Terminal to Baseplate, AC 1 min.)	V_{ISO}	2500	Volts

Static Electrical Characteristics, $T_j = 25\text{ }^\circ\text{C}$ unless otherwise specified

Characteristics	Symbol	Test Conditions	Min.	Typ.	Max.	Units
Collector-Cutoff Current	I_{CES}	$V_{CE} = V_{CES}$, $V_{GE} = 0V$	—	—	1.0	mA
Gate Leakage Current	I_{GES}	$V_{GE} = V_{GES}$, $V_{CE} = 0V$	—	—	0.5	μA
Gate-Emitter Threshold Voltage	$V_{GE(th)}$	$I_C = 20\text{mA}$, $V_{CE} = 10V$	5.0	6.0	7.0	Volts
Collector-Emitter Saturation Voltage	$V_{CE(sat)}$	$I_C = 200\text{A}$, $V_{GE} = 15V$, $T_j = 25^\circ\text{C}$	—	2.0	2.7	Volts
		$I_C = 200\text{A}$, $V_{GE} = 15V$, $T_j = 125^\circ\text{C}$	—	1.95	—	Volts
Total Gate Charge	Q_G	$V_{CC} = 300V$, $I_C = 200\text{A}$, $V_{GE} = 15V$	—	1240	—	nC
Emitter-Collector Voltage**	V_{EC}	$I_E = 100\text{A}$, $V_{GE} = 0V$	—	—	2.6	Volts

Dynamic Electrical Characteristics, $T_j = 25\text{ }^\circ\text{C}$ unless otherwise specified

Characteristics	Symbol	Test Conditions	Min.	Typ.	Max.	Units
Input Capacitance	C_{ies}		—	—	55	nf
Output Capacitance	C_{oes}	$V_{CE} = 10V$, $V_{GE} = 0V$	—	—	3.6	nf
Reverse Transfer Capacitance	C_{res}		—	—	2.0	nf
Inductive Load	Turn-on Delay Time	$V_{CC} = 300V$, $I_C = 200\text{A}$,	—	—	250	ns
	Rise Time					
Switch Time	Turn-off Delay Time	$V_{GE1} = V_{GE2} = 15V$, $R_G = 6.3\Omega$,	—	—	500	ns
	Fall Time					
Diode Reverse Recovery Time**	t_{rr}	Inductive Load Switching Operation, $I_E = 200\text{A}$	—	—	150	ns
Diode Reverse Recovery Charge**	Q_{rr}		—	3.5	—	μC

* Pulse width and repetition rate should be such that device junction temperature (T_j) does not exceed $T_{j(max)}$ rating.

**Represents characteristics of the anti-parallel, emitter-to-collector free-wheel diode (FWDi).



Powerex, Inc., 173 Pavilion Lane, Youngwood, Pennsylvania 15697 (724) 925-7272

CM200DU-12NFH
Dual IGBTMOD™ NFH-Series Module
 200 Amperes/600 Volts

Thermal and Mechanical Characteristics, $T_j = 25\text{ }^\circ\text{C}$ unless otherwise specified

Characteristics	Symbol	Test Conditions	Min.	Typ.	Max.	Units
Thermal Resistance, Junction to Case	$R_{th(j-c)Q}$	Per IGBT 1/2 Module, T_C Reference Point per Outline Drawing	—	—	0.21	$^\circ\text{C/W}$
Thermal Resistance, Junction to Case	$R_{th(j-c)D}$	Per FWDi 1/2 Module, T_C Reference Point per Outline Drawing	—	—	0.35	$^\circ\text{C/W}$
Thermal Resistance, Junction to Case	$R_{th(j-c)'Q}$	Per IGBT 1/2 Module, T_C Reference Point Under Chips	—	—	0.15	$^\circ\text{C/W}$
Contact Thermal Resistance	$R_{th(c-f)}$	Per 1/2 Module, Thermal Grease Applied	—	0.07	—	$^\circ\text{C/W}$
External Gate Resistance	R_G		3.1	—	31	Ω

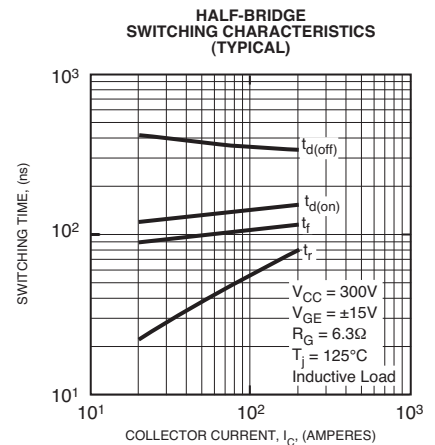
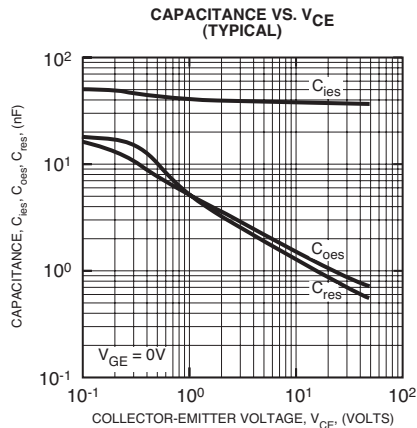
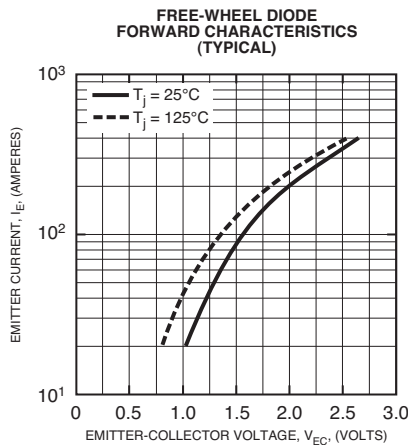
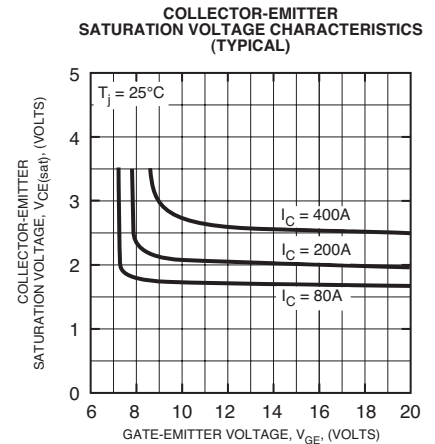
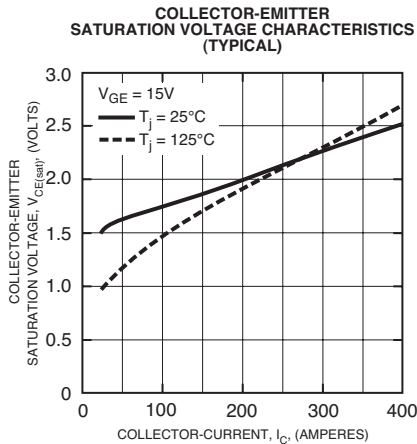
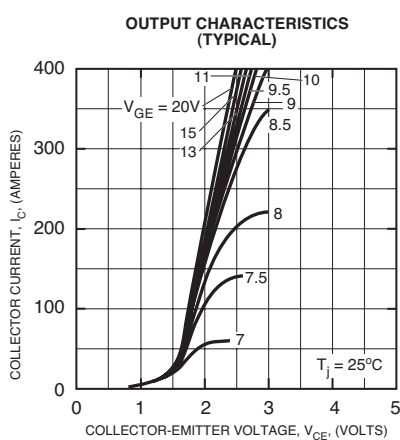



Powerex, Inc., 173 Pavilion Lane, Youngwood, Pennsylvania 15697 (724) 925-7272

CM200DU-12NFH
Dual IGBTMOD™ NFH-Series Module
 200 Amperes/600 Volts

REVERSE RECOVERY CHARACTERISTICS (TYPICAL)

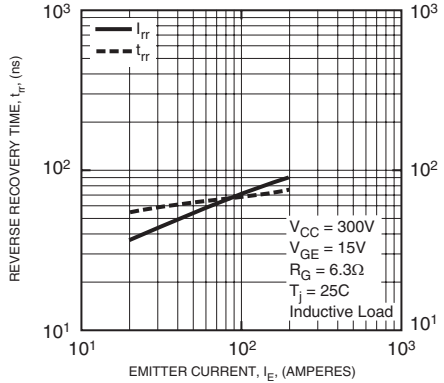

GATE CHARGE VS. V_{GE}

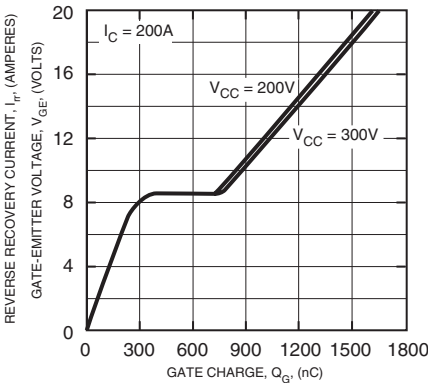

SWITCHING LOSS VS. COLLECTOR CURRENT (TYPICAL)

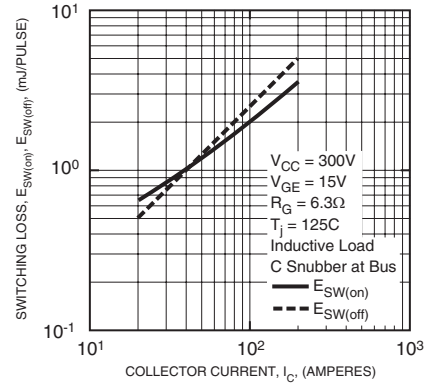

SWITCHING LOSS VS. GATE RESISTANCE (TYPICAL)

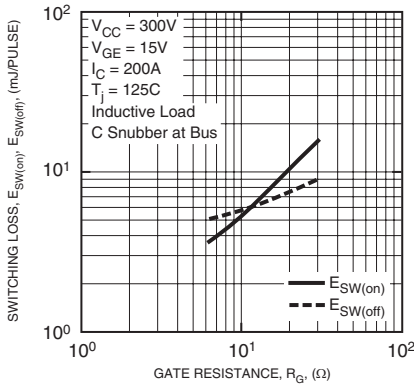

REVERSE RECOVERY SWITCHING LOSS VS. EMITTER CURRENT (TYPICAL)

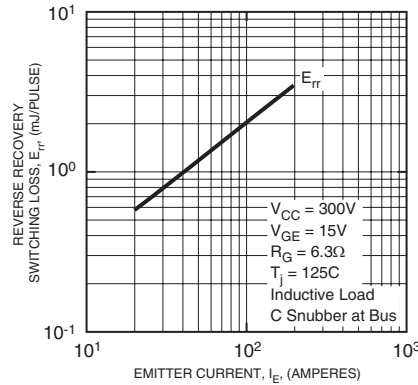

REVERSE RECOVERY SWITCHING LOSS VS. GATE RESISTANCE (TYPICAL)

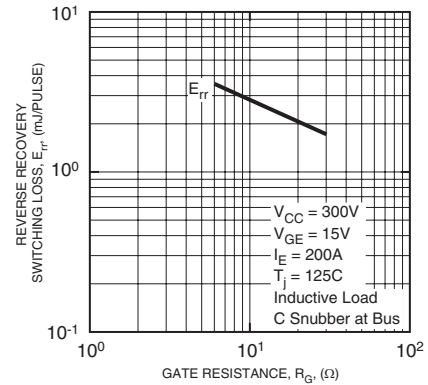

TRANSIENT THERMAL IMPEDANCE CHARACTERISTICS (IGBT & FWDi)

