

6.1 mm×4.0 mm Side-operational SMD Light Touch Switches

Type: **EVQPS**

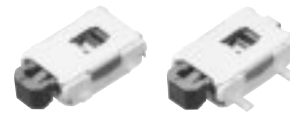

■ Features

- External dimensions : 6.1 mm×4.0 mm, Height 1.8 mm
- Terminal shapes : straight, J-bent

■ Recommended Applications

- Operating switches for other electronic equipment

■ Explanation of Part Numbers

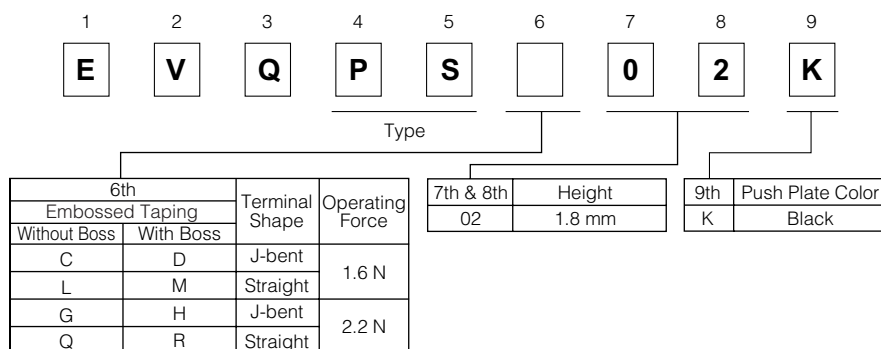



■ Specifications

Type		Snap action / Push-on type SPST
Electrical	Rating	10 μ A 2 Vdc to 50 mA 12 Vdc (Resistiv load)
	Contact Resistance	500 m Ω max.
	Insulation Resistance	100 M Ω min. (at 100 Vdc)
	Dielectric Withstanding Voltage	250 Vac for 1 minute
	Bouncing	10 ms max. (ON, OFF)
Mechanical	Operating Force	1.6 N ^{+0.7} _{-0.4} N 2.2 N ^{+0.8} _{-0.7} N
	Travel	0.3 mm ^{+0.1} _{-0.2} mm
	Push Strength	30 N for 1 minute
Endurance	Operating Life	100000 cycles min.
Operating Temperature		-20 °C to +70 °C
Storage Temperature		-40 °C to +85 °C (Bulk) -20 °C to +60 °C (Taping)
Minimum Quantity/Packing Unit		4000 pcs. Embossed Taping (Reel Pack)
Quantity/Carton		16000 pcs.



Design and specifications are each subject to change without notice. Ask factory for the current technical specifications before purchase and/or use. Should a safety concern arise regarding this product, please be sure to contact us immediately.

■ Dimensions in mm (not to scale)

<p>No. 1</p> <p>EVQPSD EVQPSH</p> <p>J-bent terminals, with Boss</p> 	<p>PWB land pattern for reference (Tolerance:±0.1)</p> <p>Circuit Diagram</p>			
<p>Part Numbers</p>	<p>Operating Force</p>	<p>Height</p>	<p>Push Plate Color</p>	<p>Operating Life</p>
<p>EVQPSD02K</p>	<p>1.6 N</p>	<p>1.8 mm</p>	<p>Black</p>	<p>100000 cycles</p>
<p>EVQPSH02K</p>	<p>2.2 N</p>	<p>1.8 mm</p>	<p>Black</p>	<p>100000 cycles</p>
<p>No. 2</p> <p>EVQPSM EVQPSR</p> <p>Straight terminals, with Boss</p> 	<p>PWB land pattern for reference (Tolerance:±0.1)</p> <p>Circuit Diagram</p>			
<p>Part Numbers</p>	<p>Operating Force</p>	<p>Height</p>	<p>Push Plate Color</p>	<p>Operating Life</p>
<p>EVQPSM02K</p>	<p>1.6 N</p>	<p>1.8 mm</p>	<p>Black</p>	<p>100000 cycles</p>
<p>EVQPSR02K</p>	<p>2.2 N</p>	<p>1.8 mm</p>	<p>Black</p>	<p>100000 cycles</p>

Design and specifications are each subject to change without notice. Ask factory for the current technical specifications before purchase and/or use.
Should a safety concern arise regarding this product, please be sure to contact us immediately.

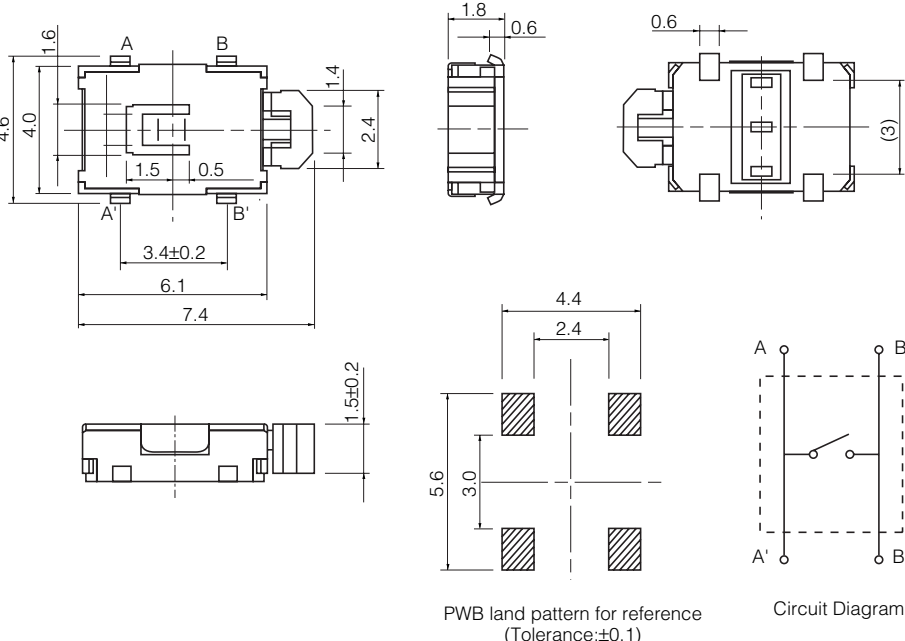
■ Dimensions in mm (not to scale)

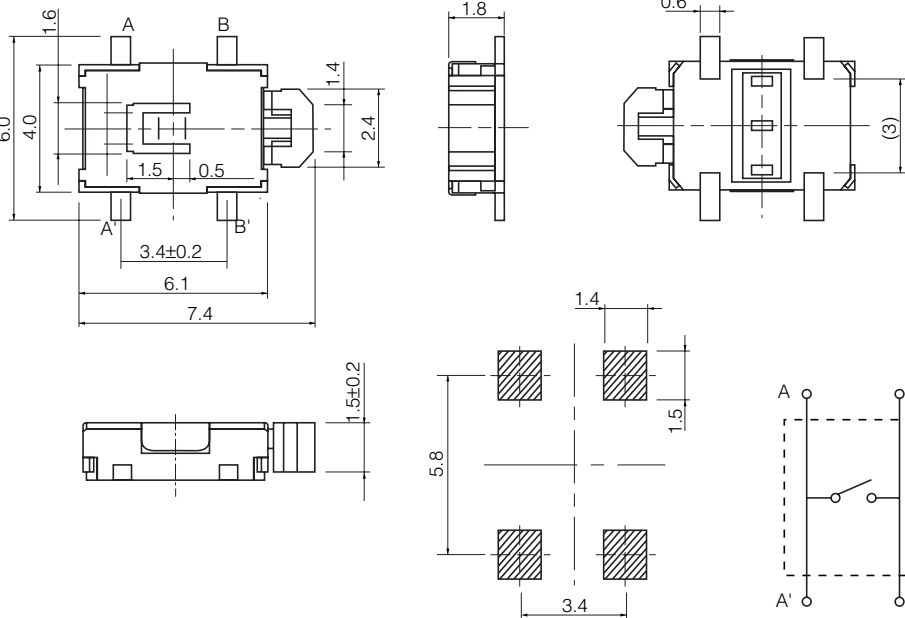
<p>No. 3</p> <p>EVQPSC EVQPSG</p> <p>J-bent terminals, without Boss</p> 	 <p>PWB land pattern for reference (Tolerance:±0.1)</p> <p>Circuit Diagram</p>			
<p>Part Numbers</p>	<p>Operating Force</p>	<p>Height</p>	<p>Push Plate Color</p>	<p>Operating Life</p>
<p>EVQPSC02K</p>	<p>1.6 N</p>	<p>1.8 mm</p>	<p>Black</p>	<p>100000 cycles</p>
<p>EVQPSG02K</p>	<p>2.2 N</p>	<p>1.8 mm</p>	<p>Black</p>	<p>100000 cycles</p>
<p>No. 4</p> <p>EVQPSL EVQPSQ</p> <p>Straight terminals, without Boss</p> 	 <p>PWB land pattern for reference (Tolerance:±0.1)</p> <p>Circuit Diagram</p>			
<p>Part Numbers</p>	<p>Operating Force</p>	<p>Height</p>	<p>Push Plate Color</p>	<p>Operating Life</p>
<p>EVQPSL02K</p>	<p>1.6 N</p>	<p>1.8 mm</p>	<p>Black</p>	<p>100000 cycles</p>
<p>EVQPSQ02K</p>	<p>2.2 N</p>	<p>1.8 mm</p>	<p>Black</p>	<p>100000 cycles</p>

Design and specifications are each subject to change without notice. Ask factory for the current technical specifications before purchase and/or use.
Should a safety concern arise regarding this product, please be sure to contact us immediately.

■ Recommended Reflow Soldering Conditions

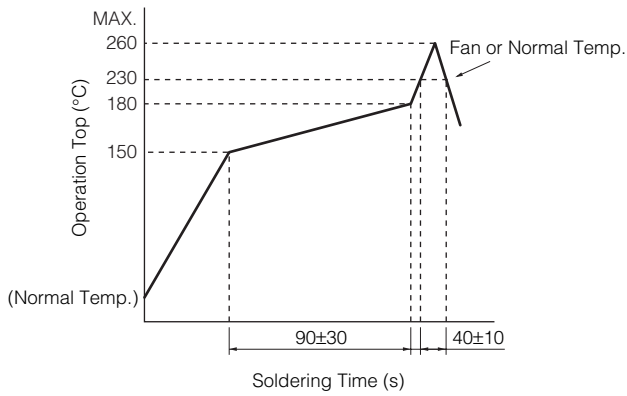

● Embossed Carrier Taping

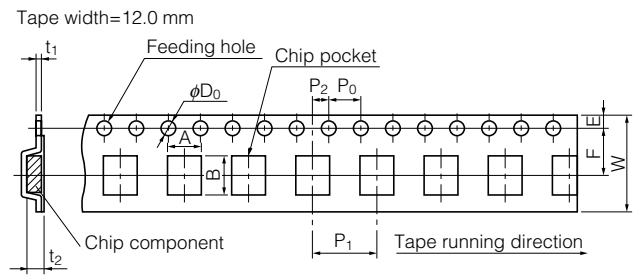

Unit: mm

Part No.	Height	A	B	W	F	E	P ₁	P ₂	P ₀	D ₀ Dia.	t ₁	t ₂
EVQPS	1.8	6.8±0.2	8.0±0.2	16.0±0.3	7.5±0.1	1.75±0.10	8.0±0.1	2.0±0.1	4.0±0.1	1.5 ^{+0.1} ₋₀	0.30±0.05	2.7±0.2

● Standard Reel Dimensions in mm (not to scale)

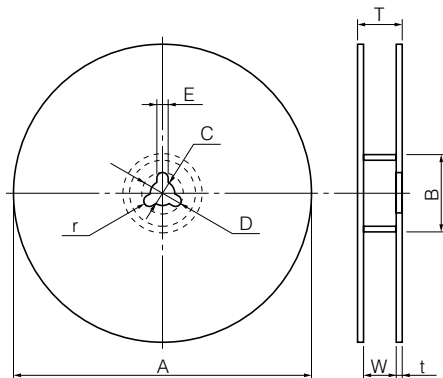

Item	A	B	C	D	E
Rate (mm)	φ370.0±2.0	φ50.0 min.	φ13.0±0.5	φ21.0±1.0	2.0±0.5

Item	W	T	t	r
Rate (mm)	18.0±1.5	—	1.0 to 3.0	1.0±0.5