

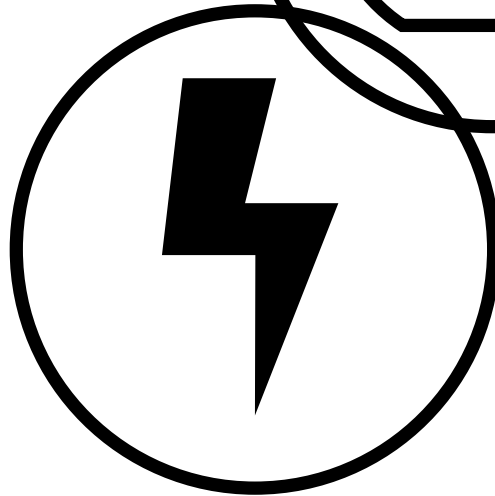

**WORLD PRODUCTS INC.**  
ELECTRONIC COMPONENT SOLUTIONS

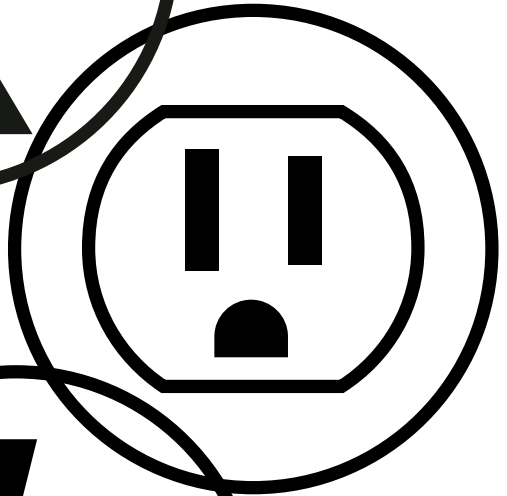

# MICRO INDUCTORS

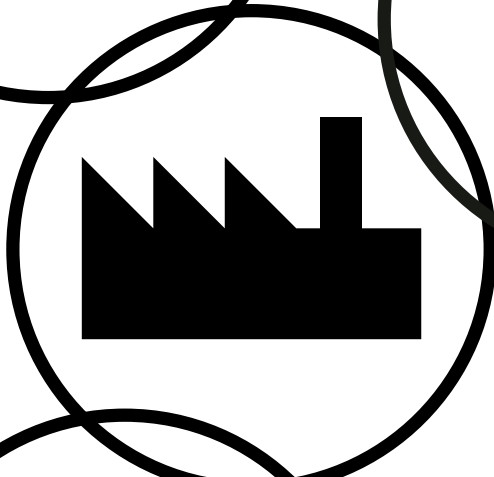
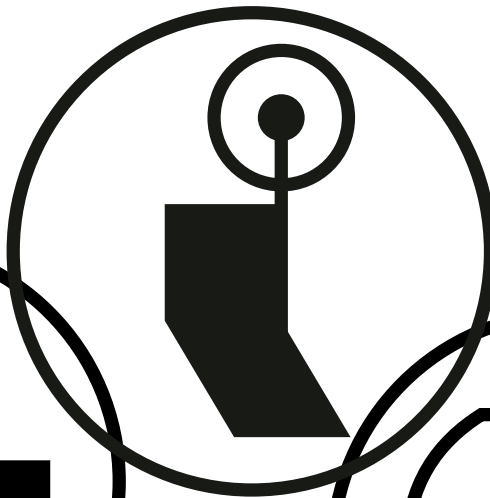
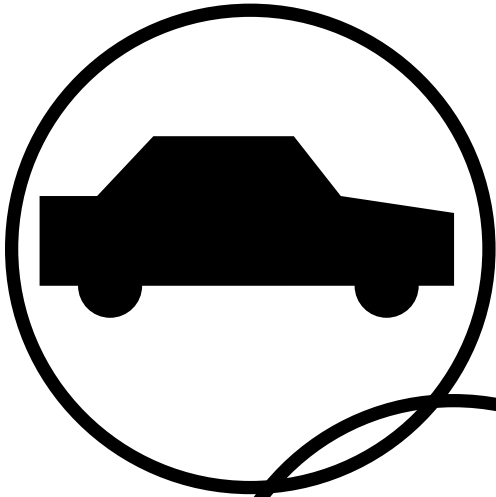

# MICRO INDUCTORS

## Features

1. Very high Self-Resonant Frequencies
2. Ultra miniature size (0.6mm x 0.3mm x 0.3mm) and low weight.
3. No polarity
4. Terminal electrode has excellent solder heat resistance for soldering.
5. Elimination of leads.
6. RoHS compliant with Directive 2002/95/EC of the European Parliament and of the Council of 27 January 2003 on the restriction of the use of certain hazardous substances in electrical and electronic equipment (RoHS Directive) and comply to a maximum concentration value of 0.1% by weight in homogeneous materials for lead (Pb), mercury, hexavalent chromium, polybrominated biphenyls (PBB) and polybrominated diphenyl ethers (PBDE) and of 0.01% weight in homogeneous materials for cadmium.

## Applications

1. Bluetooth module
2. CDMA, TDMA, GSM, PCS Phone
3. RF module of telecommunication products.
  - Cellular phone, Cordless telephone, Pagers etc.
4. PAM (Power Amp Module)
5. Computer communications, Radar detectors.

## Ordering Information

**WPM** - **0603** - **22** **J** **T**  
 (1) (2) (3) (4) (5)

- (1) **Series**  
**WPM:** Micro Inductors
- (2) **Dimensions\***  
 First two digits: length (mm)  
 Last two digits: width (mm)
- (3) **Inductance**  
 nH value
- (4) **Tolerance**  
**S:**  $\pm 0.3nH$   
**J:**  $\pm 5\%$
- (5) **Packaging**  
**B:** Bulk Package  
**T:** Tape & Reel ( $\phi$  178mm [7 inches])  
**L:** Tape & Reel ( $\phi$  254mm [10 inches])

\*0603(mm) is equivalent to 0201 (inches).  
 1005(mm) is equivalent to 0402 (inches).

## Shape and Dimensions

Type	L	W	T	C <sub>1</sub>
WPM-0603	0.6 $\pm$ 0.03 [.024 $\pm$ .001]	0.3 $\pm$ 0.03 [.012 $\pm$ .001]	0.3 $\pm$ 0.03 [.012 $\pm$ .001]	0.15 $\pm$ 0.05 [.006 $\pm$ .002]
WPM-1005	1.0 $\pm$ 0.05 [.039 $\pm$ .002]	0.5 $\pm$ 0.05 [0.20 $\pm$ .002]	0.5 $\pm$ 0.05 [.020 $\pm$ 0.02]	0.20 $\pm$ 0.10 [.008 $\pm$ .004]

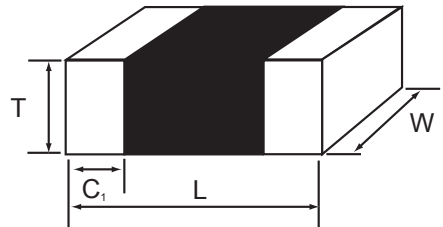

# MICRO INDUCTORS

## Specifications

### 0603 Series

Part No.	Inductance (at 100MHz)		Q (Min)		Q(Typ)		SRF(GHz)	DCR( $\Omega$ )		Rated current (mA) max.
	nH	Tolerance	100MHz	100MHz	800MHz	1000MHz	min.	max.		
WPM-0603-1.0S	1.0	$\pm 0.3nH$	3	4.0	13.3	15.0	19.0	0.20	400	
WPM-0603-1.2S	1.2		3	4.0	13.3	15.0	19.0	0.25	400	
WPM-0603-1.5S	1.5		3	4.0	13.2	14.8	18.0	0.30	400	
WPM-0603-1.8S	1.8		3	4.1	13.2	14.6	17.0	0.35	400	
WPM-0603-2.2S	2.2		3	4.1	13.0	14.5	15.0	0.40	400	
WPM-0603-2.7S	2.7		3	4.1	13.0	14.5	14.0	0.45	350	
WPM-0603-3.3S	3.3		3	4.2	12.8	14.3	13.0	0.50	350	
WPM-0603-3.9S	3.9		3	4.2	12.8	14.2	12.0	0.55	350	
WPM-0603-4.7S	4.7		3	4.2	12.6	14.2	10.0	0.60	350	
WPM-0603-5.6S	5.6		3.5	4.3	12.5	14.0	10.0	0.70	350	
WPM-0603-6.8J	6.8	$\pm 5\%$	3.5	4.3	12.5	14.0	9.0	0.80	300	
WPM-0603-8.2J	8.2		3.5	4.5	12.7	14.0	8.0	0.90	300	
WPM-0603-10J	10		3.5	4.8	13.0	14.3	8.0	1.00	250	
WPM-0603-12J	12		4	4.8	12.0	13.5	7.0	1.10	250	
WPM-0603-15J	15		4	4.7	11.5	13.0	6.0	1.20	200	
WPM-0603-18J	18		4	4.5	11.0	12.0	5.0	1.40	200	
WPM-0603-22J	22		4	4.5	10.2	11.0	5.0	1.60	150	

#### Test Equipment & Fixture

L, Q : RF Impedance Analyzer 4991A(Agilent) , Test Fixture 16196C(Agilent)  
 SRF : Network Analyzer 8722ES (Agilent)  
 Rdc : TWA-161A,B

## Electrical Characteristics

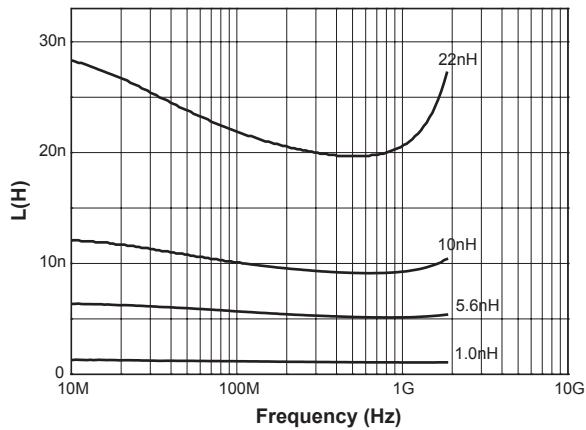

Inductance vs. Frequency

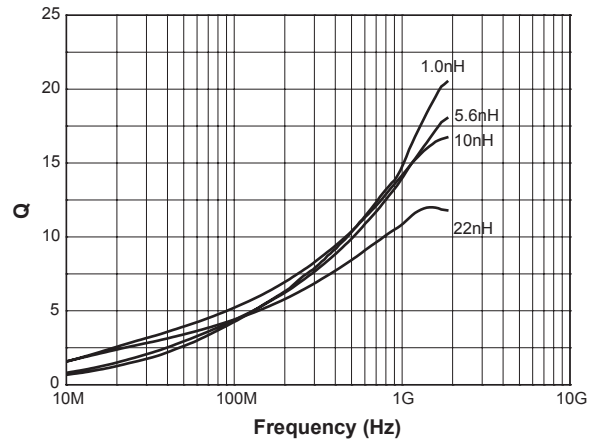

Q vs. Frequency

# MICRO INDUCTORS

## Specifications

### 1005 Series

Part No.	Inductance (at 100MHz)		Q (Min)		Q(Typ)		SRF(GHz)		Rated current (mA) max.
	nH	Tolerance	100MHz	100MHz	800MHz	1000MHz	min.	max.	
WPM-1005-1.0S	1.0	±0.3nH	4.0	8.0	20.5	23.7	20.0	0.10	300
WPM-1005-1.2S	1.2		4.0	8.4	21.2	24.9	20.0	0.15	300
WPM-1005-1.5S	1.5		4.0	8.4	21.2	25.4	14.0	0.20	300
WPM-1005-1.8S	1.8		4.0	9.2	21.5	26.9	13.0	0.20	300
WPM-1005-2.2S	2.2		4.0	8.6	22.2	26.8	12.0	0.23	300
WPM-1005-2.7S	2.7		4.5	8.4	22.8	26.0	10.0	0.25	250
WPM-1005-3.3S	3.3		5.0	9.0	22.2	26.5	10.0	0.25	250
WPM-1005-3.9S	3.9		5.0	9.2	23.1	26.6	10.0	0.30	250
WPM-1005-4.7S	4.7		5.5	9.6	23.2	26.9	8.0	0.35	250
WPM-1005-5.6S	5.6		5.5	8.8	23.3	27.0	7.0	0.35	250
WPM-1005-6.8J	6.8	± 5%	5.5	8.5	21.3	27.1	6.5	0.40	200
WPM-1005-8.2J	8.2		5.5	9.1	22.7	27.2	5.6	0.50	200
WPM-1005-10J	10		5.5	8.3	22.5	27.5	5.4	0.50	200
WPM-1005-12J	12		7.0	8.6	24.1	27.4	4.1	0.50	200
WPM-1005-15J	15		7.0	8.9	22.4	28.5	4.0	0.60	200
WPM-1005-18J	18		7.0	9.3	24.6	30.4	3.7	0.70	200
WPM-1005-22J	22		7.0	8.7	23.4	26.2	3.5	0.75	200
WPM-1005-27J	27		7.0	9.0	26.5	30.2	3.4	0.80	200
WPM-1005-33J	33		7.0	8.6	24.8	28.0	3.2	1.00	200
WPM-1005-39J	39		7.0	9.1	24.1	26.1	2.5	1.10	100
WPM-1005-47J	47	7.0	8.7	24.6	26.5	2.4	1.20	100	
WPM-1005-56J	56	7.0	9.0	24.5	25.8	2.3	1.40	100	
WPM-1005-68J	68	7.0	10.1	25.5	27.7	2.2	1.60	100	
WPM-1005-82J	82	7.0	10.3	24.5	25.9	2.1	1.80	100	
WPM-1005-100J	100	7.0	9.2	23.2	24.2	2.0	2.00	100	

#### Test Equipment & Fixture

L, Q : RF Impedance Analyzer 4991A(Agilent) , Test Fixture 16193A(Agilent)  
 SRF : Network Analyzer 8722ES (Agilent) ,  
 Rdc : TWA-161A,B

## Electrical Characteristics

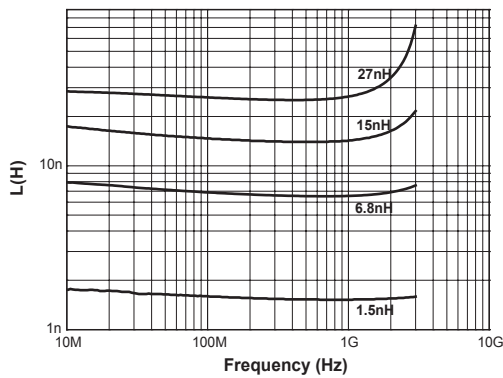

Inductance vs Frequency

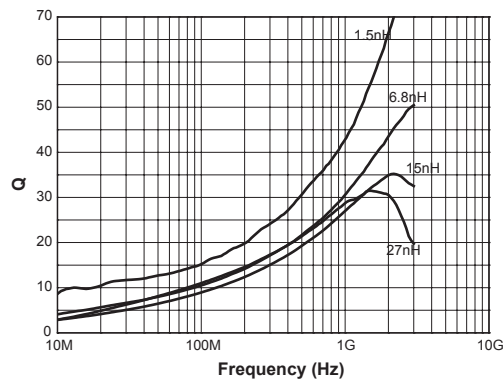

Q vs Frequency

# MICRO INDUCTORS

## Reliability and Test Conditions

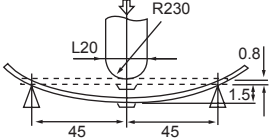
ITEM	REQUIREMENTS	TEST CONDITION
Operating temp. range	-55°C~+125°C ≥	-
Storage temp. & humidity range	-40°C max. , 70% RH max.	at packing condition
Resistance to solder heat	1.No damage such as cracks should be visible in chip element. 2.More than 75% of the terminal electrode shall be covered with new solder. 3.Inductance change : ±within 5% 4.Quality factor change : ±within 30%	Preheat temperature : 100 to 150°C Preheat time : 1min Solder temperature : 260 ±10°C Dipping time : 10 ±0.5sec.
Solderability	1.More than 90% of the terminal electrode shall be covered with new solder. 2.Inductance change : ±within 5% 3.Quality factor change : ±within 30%	Preheat temperature : 100 to 150°C Preheat time : 1min Solder temperature : 230 ±10°C Dipping time : 3 ±1sec.
Reflow soldering	1.More than 50% of the terminal electrode shall be covered with new solder. <div style="text-align: center;">  <p style="text-align: center;"><math>S \geq T * 0.5</math></p> </div>	Preheat temperature : 150°C Preheat time : 1min Solder temperature : 230°C Soldering time : 10 sec. max. (Reflow soldering profile)
Bending Test	1.No mechanical damage.	<div style="text-align: center;">  </div>

# MICRO INDUCTORS

ITEM	REQUIREMENTS	TEST CONDITION
Drop	1.No mechanical damage.	Drop 10 times on a concrete floor from a height of 91cm
Vibration	1.No mechanical damage.	Frequency: 10~55~10Hz Amplitude: 1.52mm Direction and time: X,Y,Z directions for 2 hours
Thermal shock (Temperature cycle)	1.No mechanical damage. 2.Inductance change: $\pm$ within 5% 3.Quality factor change: $\pm$ within 30%	Step1. $-40 \pm 3^{\circ}\text{C}$ 30 $\pm$ 3min. Step2. $85 \pm 3^{\circ}\text{C}$ 30 $\pm$ 3min. Number of cycle: 100 times
Heat load resistance	1.No mechanical damage. 2.Inductance change: $\pm$ within 5% 3.Quality factor change: $\pm$ within 30%	Temperature: $85 \pm 2^{\circ}\text{C}$ Applied current: rated current Time: 1,000 hours Measured at ambient temperature after placing for 24 hours
Low temp. resistance	1.No mechanical damage. 2.Inductance change: $\pm$ within 5% 3.Quality factor change: $\pm$ within 30%	Temperature: $-40 \pm 5^{\circ}\text{C}$ Time: 1,000 hours Measured at ambient temperature after placing for 24 hours
Humidity resistance	1.No mechanical damage. 2.Inductance change: $\pm$ within 5% 3.Quality factor change: $\pm$ within 30%	Temperature: $40 \pm 2^{\circ}\text{C}$ Humidity: 90~95% RH Time: 500 hours Measured at ambient temperature after placing for 24 hours
Humidity load resistance	1.No mechanical damage. 2.Inductance change: $\pm$ within 5% 3.Quality factor change: $\pm$ within 30%	Temperature: $40 \pm 2^{\circ}\text{C}$ Applied current: rated current Time: 500 hours Measured at ambient temperature after placing for 24 hours

## Land Pattern Design

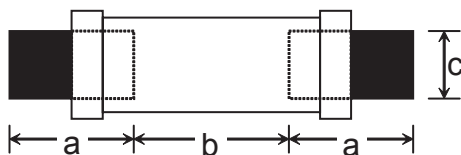

Size	unit:mm		
	a	b	c
0603	0.22	0.25	0.32
1005	0.7	0.4	0.5

## Labeling

### Label

- 1) Part name.
- 2) Lot No.
- 3) Quantity.

### Standard quantity for packing (pcs)

Packing Type(EIA)	Tape & reel			Bulk
	Reel	Inner box	Carton box	Vinyl or Cassette
0603	10,000	100,000	400,000	As requested
1005	10,000	100,000	400,000	

\*Packing method can be changed upon request.

**Tape Dimensions**

**Paper**

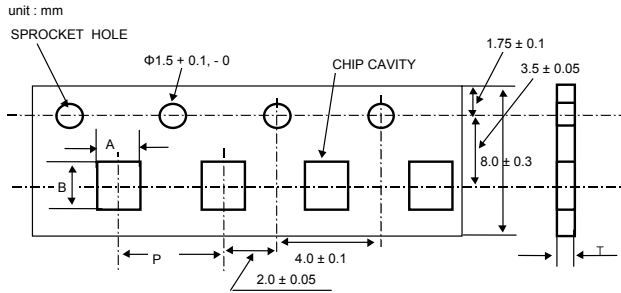

unit: mm

Type	A ± 0.1	B ± 0.1	P ± 0.1	T (max.)
0603	0.37±0.02	0.67±0.02	4.0±0.1	0.45
1005	0.65±0.1	1.15±0.1	2.0±0.1	0.8

**Leader and Blank Portion**

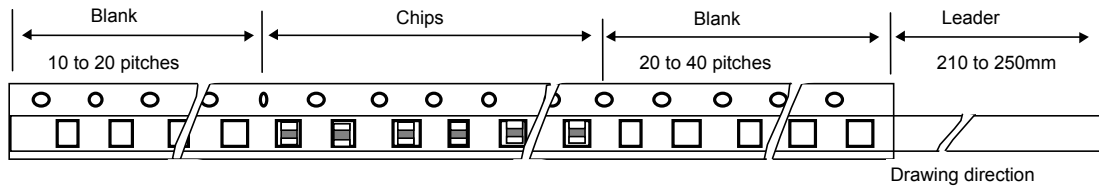

The pitch holes shift within  $\pm 0.3\text{mm}$  for cumulative 10 pitches.

**Reel Dimensions**

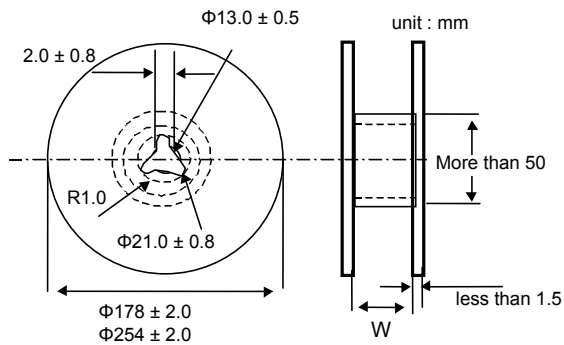

Type	W (mm)
0603, 1005	$9.0 \pm 0.3$

**Top Cover Tape Strength**

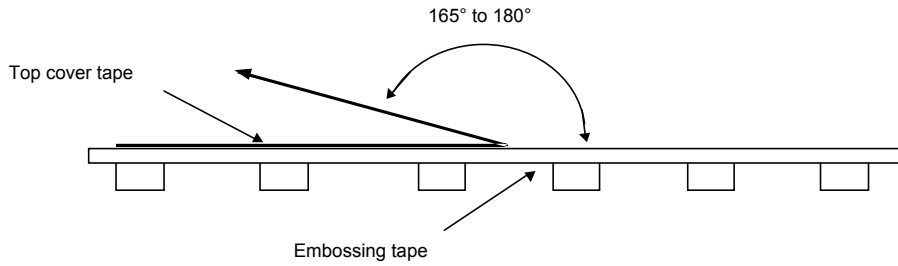

The force for tearing off top cover tape is 20 to 70 grams in the arrow direction.

**Soldering Profile**

**REFLOW SOLDERING(Peak 230°C)**

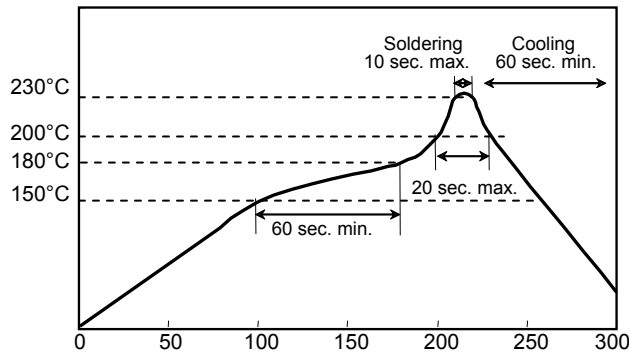

**REFLOW SOLDERING (Peak 250°C)**

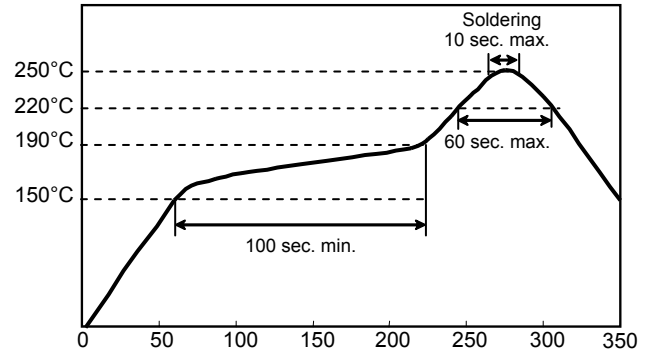

**FLOW SOLDERING**

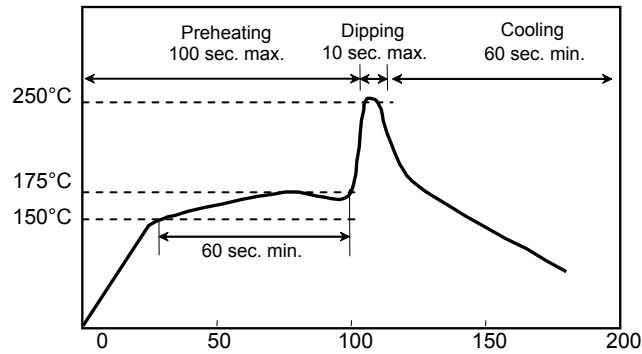

**MANUAL SOLDERING**

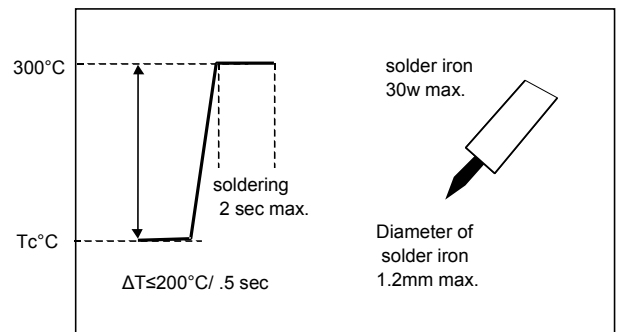



## Precaution for Product Storage

---

Electrical characteristics of product will not change when stored under typical environmental conditions.

However, it is possible that the solderability of the terminal electrodes and the characteristics of the tape packaging can change during storage. For this reasons, the following storage guidelines should be followed.

### STORAGE ENVIRONMENT

The tape packaging material is designed to withstand long-term storage but it may degrade more rapidly in the presence of high temperature or high humidity. Therefore, product shall be stored in an ambient temperature of less than 40°C with a relative humidity of less than 70%. The products should be used within 6 months of receipt.

To achieve best solderability, product should be used as soon as possible after unpacking. Leftover product must be stored in dry condition with desiccant.

### CORROSIVE GASES

Since sulfur and chlorine may degrade the solderability of the terminal electrodes, it is important to store the product in an environment free of such gases.

### TEMPERATURE FLUCTUATIONS

Dew condensation may occur when the product is taken out of storage due to variation of temperature. It is important to maintain a temperature-controlled environment.

DISCLAIMER: The names of the products and the specifications in this catalog are subject to change without notice for the sake of improvement. World Products Inc. also reserves the right to discontinue any of these products. The products in this catalog are intended for use in ordinary electronic products. If any of these products are to be used in special applications requiring extremely high reliability, where product defects might pose a safety risk, please consult World Products Inc. Though World Products Inc. has taken all possible precautions to ensure the quality and reliability of its products, improper use of products may result in bodily injury, fire, or similar accident. If you have any questions regarding the use of the products in question, please consult World Products Inc. Please be advised that World Products Inc. accepts no responsibility for any infraction by users of World Products Inc. products on third party patents or industrial copyrights.