



Typical Applications

High Dynamic Range Infrastructure:

- GSM, GPRS & EDGE
- CDMA & W-CDMA
- Cable Modem Termination Systems

Features

- +35 dBm Input IP3
- Conversion Loss: 8.5 dB
- Low External Part Count
- Ultra Small MSOP8 Package: 14.8 mm²
- Included in the HMC-DK003 Designer's Kit

Functional Diagram

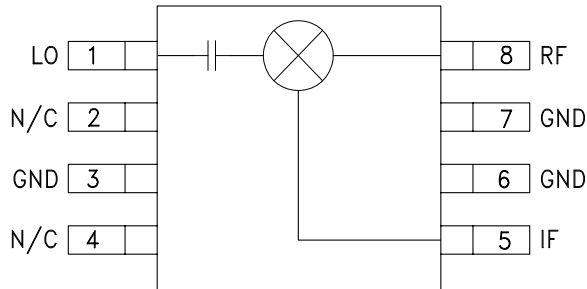

General Description

The HMC399MS8(E) is a high dynamic range passive MMIC mixer in plastic surface mount 8 lead Mini Small Outline Package (MSOP) covering 700 to 1000 MHz. Excellent input IP3 performance of +35 dBm for down conversion and +32 dBm for up conversion is provided for 2.5G & 3G GSM/CDMA based cellular applications at an LO drive of +17 dBm. With a 1 dB compression of +23 dBm, the RF port will accept a wide range of input signal levels. Conversion loss is 8.5 dB typical and LO isolations are maintained at 23 to 35 dB. This miniature single-ended monolithic GaAs FET mixer requires only one external inductor to optimize the LO frequency response. The 50 to 250 MHz IF frequency response will satisfy many cellular transmit or receive frequency plans. The HMC399MS8(E) input IP3 performance coupled with its high P1dB rivals traditional active FET mixers while offering a much smaller 14.8mm² standard IC footprint and no DC bias.

Electrical Specifications, $T_A = +25^\circ\text{C}$, LO = +17 dBm, IF = 200 MHz ^[1]

Parameter	Min.	Typ.	Max.	Min.	Typ.	Max.	Min.	Typ.	Max.	Units
Frequency Range, RF		740 - 800		800 - 900			880 - 960			MHz
Frequency Range, LO ^[2]		540 - 740		550 - 840			630 - 900			MHz
Frequency Range, IF		DC - 200		DC - 250			DC - 250			MHz
Conversion Loss		9	10		8.5	9.5		8	10	dB
Noise Figure (SSB)		9	10		8.5	9.5		8	10	dB
LO to RF Isolation	19	23		20	24		21	25		dB
LO to IF Isolation	22	27		26	31		29	35		dB
IP3 (Input)	30	34		31	35		30	34		dBm
1 dB Gain Compression (Input)	20	24		19	23		18	22		dBm
LO Input Drive Level (Typical)		+16 to +18		+16 to +18			+16 to +18			dBm

[1] Unless otherwise noted, all measurements performed as a downconverter with low side LO & IF = 200 MHz

[2] LO Frequency optimized. See application circuit herein.

**Conversion Gain vs.
Temperature @ LO = +17 dBm**

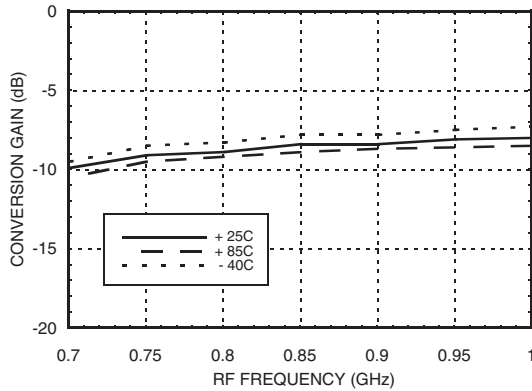

Isolation @ LO = +17 dBm

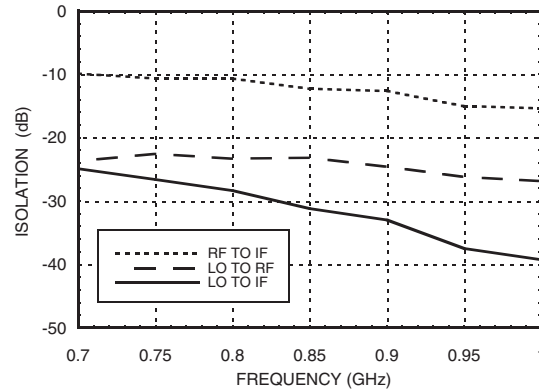

Conversion Gain vs. LO Drive

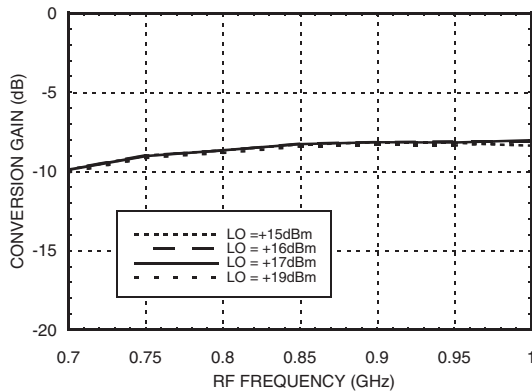

Return Loss @ LO = +17 dBm*

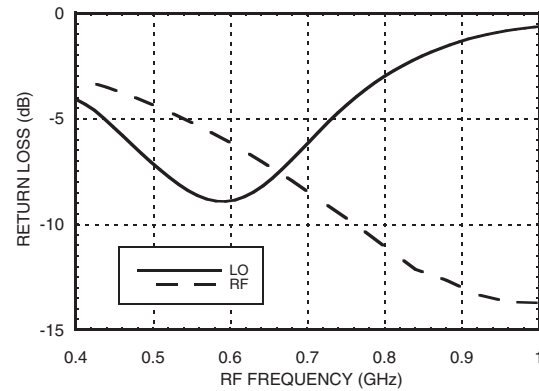

If Bandwidth @ LO = +17 dBm

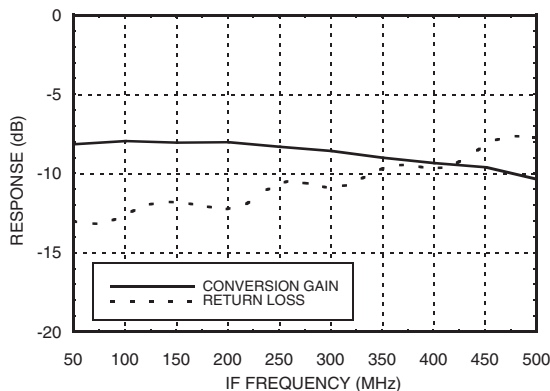

**Upconverter Conversion Gain
@ LO = +17 dBm**

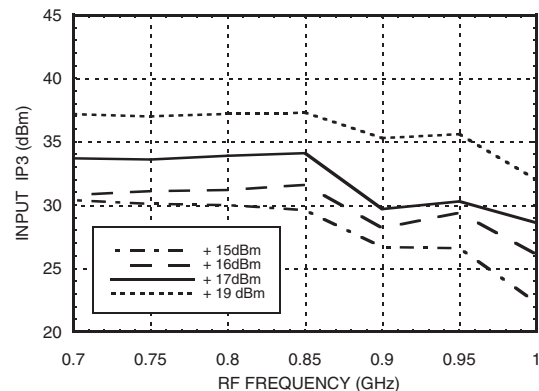

Input IP3 vs. IF Frequency, RF = 850 MHz

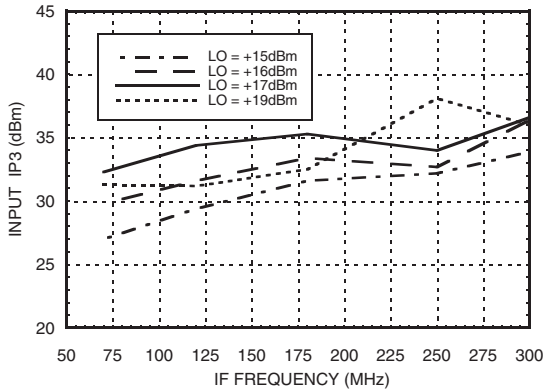

Input IP3 vs. Temperature @ LO = +17 dBm

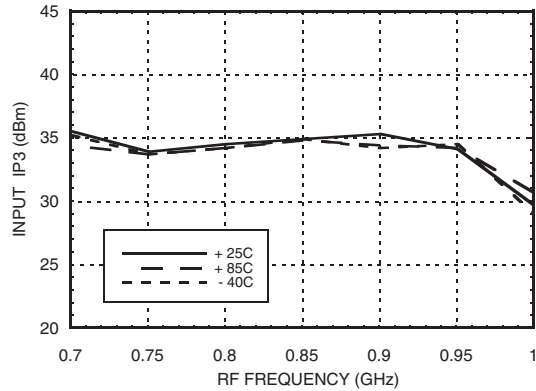

Input IP3 vs. IF Frequency, RF = 950 MHz

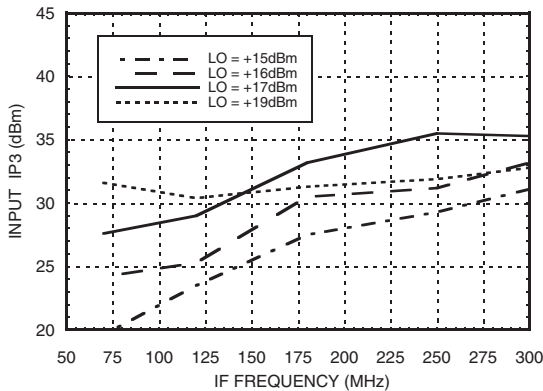

Input IP3 vs. LO Drive

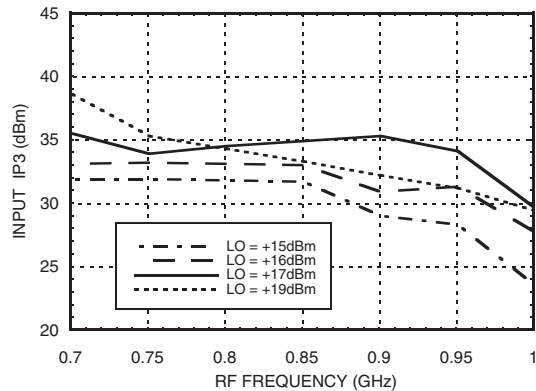

Input P1dB vs. Temperature @ LO = +17 dBm

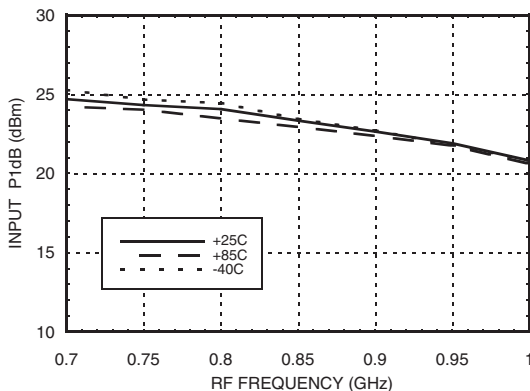

Upconverter Input IP3 vs. LO Drive

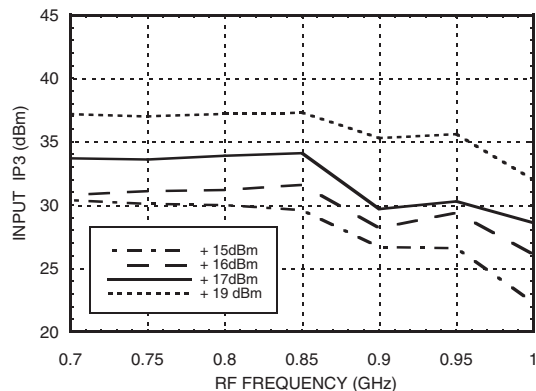



**Input IP2 vs.
Temperature @ LO = +17 dBm**

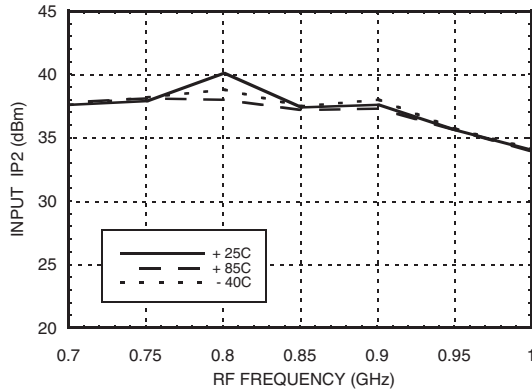

Input IP2 vs. LO Drive

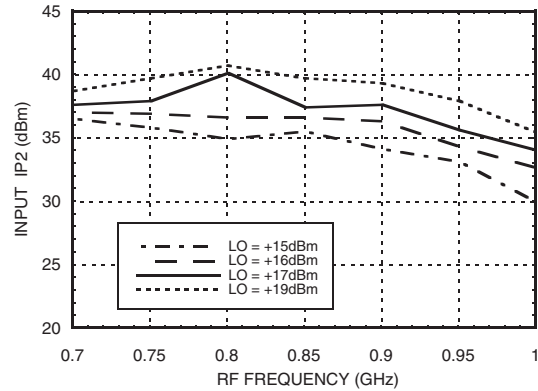

MxN Spurious Outputs

mRF	nLO				
	0	1	2	3	4
0	xx	-9	17	2	23
1	3	0	17	28	26
2	69	75	57	62	65
3	80	71	82	69	80
4	81	81	81	80	80

RF Freq = 0.801 GHz @ -10 dBm
LO Freq = 0.601 GHz @ +17 dBm
All values in dBc relative to the IF power level.

Harmonics of LO

LO Freq (GHz)	nLO Spur @ RF Port			
	1	2	3	4
0.4	34	54	38	45
0.5	30	39	35	47
0.6	26	35	33	54
0.7	24	37	36	47
0.8	23	33	42	50
0.9	25	31	46	43

LO = +17 dBm
All values are in dBc below input LO level @ RF port.



Absolute Maximum Ratings

RF/IF Input	+25 dBm
LO Drive	+27 dBm
Storage Temperature	-65 to +150 °C
Operating Temperature	-40 to +85 °C
IF DC Current	±40 mA



**ELECTROSTATIC SENSITIVE DEVICE
OBSERVE HANDLING PRECAUTIONS**

Outline Drawing

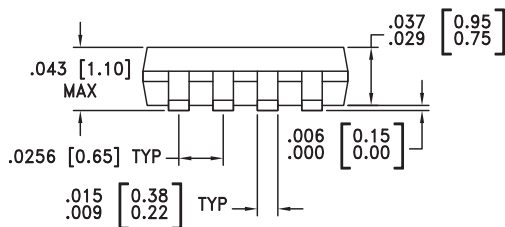
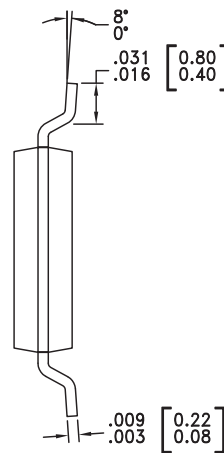
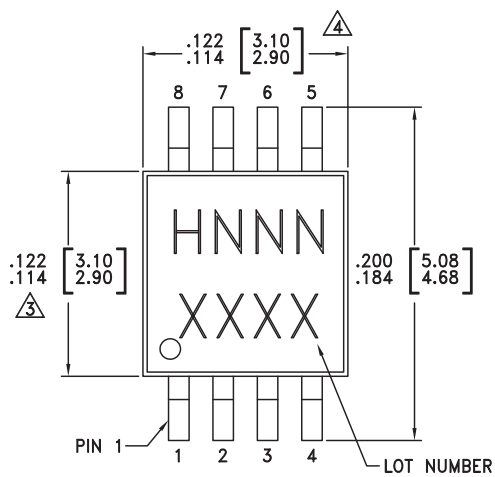

NOTES:

1. LEADFRAME MATERIAL: COPPER ALLOY
2. DIMENSIONS ARE IN INCHES [MILLIMETERS]
3. DIMENSION DOES NOT INCLUDE MOLDFLASH OF 0.15mm PER SIDE.
4. DIMENSION DOES NOT INCLUDE MOLDFLASH OF 0.25mm PER SIDE.
5. ALL GROUND LEADS MUST BE SOLDERED TO PCB RF GROUND.

Package Information

Part Number	Package Body Material	Lead Finish	MSL Rating	Package Marking ^[3]
HMC399MS8	Low Stress Injection Molded Plastic	Sn/Pb Solder	MSL1 ^[1]	H399 XXXX
HMC399MS8E	RoHS-compliant Low Stress Injection Molded Plastic	100% matte Sn	MSL1 ^[2]	H399 XXXX

[1] Max peak reflow temperature of 235 °C



[2] Max peak reflow temperature of 260 °C

[3] 4-Digit lot number XXXX

For price, delivery, and to place orders, please contact Hittite Microwave Corporation:
20 Alpha Road, Chelmsford, MA 01824 Phone: 978-250-3343 Fax: 978-250-3373
Order On-line at www.hittite.com

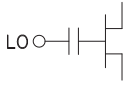

Pin Descriptions

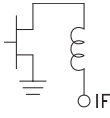
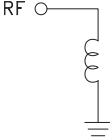
Pin Number	Function	Description	Interface Schematic
1	LO	This pin is AC coupled & matched to 50 Ohms when an external inductor (L1) is connected in series with the LO. Choose value of L1 to optimize LO frequency response.	
2, 4	N/C	Not connected.	
3, 6, 7	GND	This pin must be connected to RF ground.	
5	IF	This pin is DC coupled. For applications not requiring operation to DC this port should be DC blocked externally using a series capacitor. Choose value of C1 to pass IF frequency desired. For operation to DC, this pin must not sink/source more than 40 mA of current or failure may result.	
8	RF	This pin is DC coupled & matched to 50 Ohms from 700 - 1000 MHz	

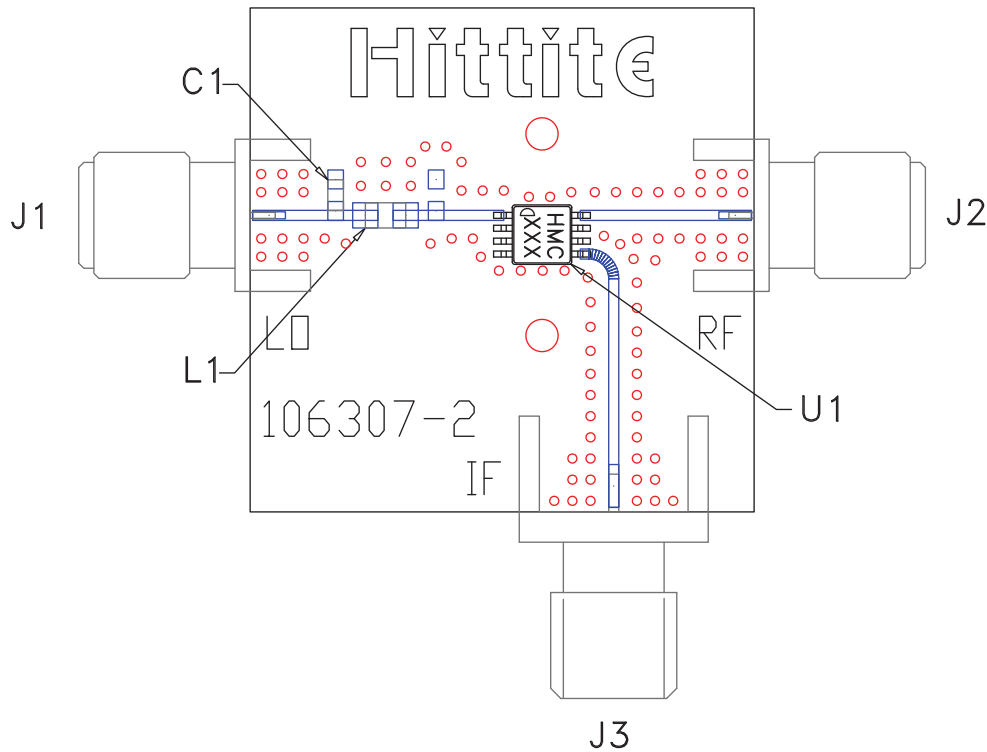
Evaluation PCB

List of Materials for Evaluation PCB 106334 [1]

Item	Description
J1 - J3	PCB Mount SMA RF Connector
C1	4 pF Capacitor, 0603 Pkg.
L1	24 nH Chip Inductor, 0805 Pkg
U1	HMC399MS8 / HMC399MS8E Mixer
PCB [2]	106307 Eval Board

[1] Reference this number when ordering complete evaluation PCB

[2] Circuit Board Material: Rogers 4350

The circuit board used in the final application should use RF circuit design techniques. Signal lines should have 50 ohm impedance while the package ground leads should be connected directly to the ground plane similar to that shown. A sufficient number of via holes should be used to connect the top and bottom ground planes. The evaluation circuit board shown is available from Hittite upon request.

Application Circuit

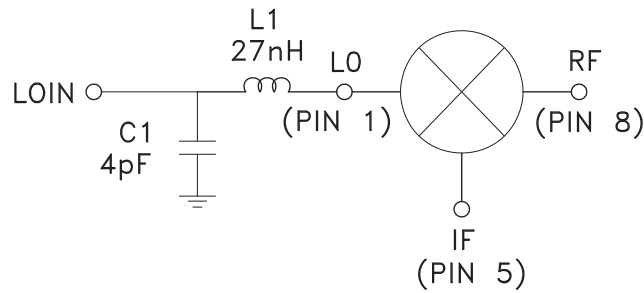

Selection of L1 for Optimal LO Frequency $\pm 10\%$

Choose value of L1 to optimize LO Frequency response. For best results use an 0805 size RF inductor or smaller.

IF (MHz)	LO Frequency (MHz)	L1 (nH)	C1 pF
250	600	27	4
170	700	22	4
100	800	18	5
70	850	15	5