

SERIES 2980

MIL-STD-883 COMPLIANT

HIGH-VOLTAGE, HIGH-CURRENT SOURCE DRIVERS

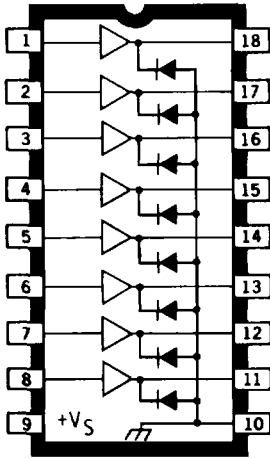

Dwg. No. A-10,243

ABSOLUTE MAXIMUM RATINGS at +25°C Free-Air Temperature

Output Voltage Range, V_{CE}	
(UDS2981 and UDS2982H/R)	5 V to 50 V
(UDS2983 and UDS2984H/R)	35 V to 80 V
Input Voltage, V_{IN}	
(UDS2981 and UDS2983H/R)	15 V
(UDS2982 and UDS2984H/R)	30 V
Output Current, I_{OUT}	-500 mA
Ground Terminal Current, I_{GND}	3.0 A
Power Dissipation, P_D	
(any one driver)	1.1 W
(total package)	See Graph
Operating Temperature Range, T_A	-55°C to +125°C
Storage Temperature Range, T_S	-65°C to +150°C

Series UDS2980H and UDS2980R hermetically sealed source drivers link standard low-power digital logic and relays, solenoids, magnetic print hammers, stepping motors, LEDs, and lamps in applications requiring separate logic and load grounds, load supply voltages to +80 V, and load currents to 500 mA.

Types UDS2981H/R and UDS2983H/R are intended for use with 5 V logic systems (TTL, Schottky TTL, DTL and 5 V CMOS). UDS2982H/R and UDS2984H/R integrated circuits are intended for MOS interface (PMOS and CMOS) operating from supply voltages of from 6 to 16 V.

Types UDS2981H/R and UDS2982H/R will withstand an output OFF voltage of 50 V. UDS2983H/R and UDS2984H/R drivers will withstand a maximum output OFF voltage of 80 V.

Under normal operating conditions, the devices will sustain 50 mA continuously on each of the eight outputs at an ambient temperature of +85°C and with a supply voltage of 15 V. All types include input current-limiting resistors and output transient-suppression diodes. In all cases, outputs are switched ON by an active high input level.

Note that the maximum current rating may not be obtained at -55°C because of reduced beta, or at +125°C because of package power limitations.

Series UDS2980H drivers are furnished in 18-pin ceramic/metal (side-brazed) hermetic dual in-line packages. Series UDS2980R drivers are supplied in ceramic/glass (cer-DIP) hermetic packages. Both are processed to the requirements of MIL-STD-883, Class B.

The same circuits are also available in 18-pin plastic dual in-line packages (Series UDN2980A) for operation over a limited temperature range, or where higher package power dissipation is needed.

FEATURES

- TTL, DTL, PMOS, or CMOS Compatible Inputs
- 500 mA Output Source Current Capability
- Transient-Protected Outputs
- High-Reliability Screening to MIL-STD-883, Class B
- Operating Temperature -55°C to +125°C

Always order by complete part number, e.g., **UDS2981H883**.
See table on next page for differences between devices.

SERIES 2980 HIGH-VOLTAGE, HIGH-CURRENT SOURCE DRIVERS

ONE OF EIGHT DRIVERS

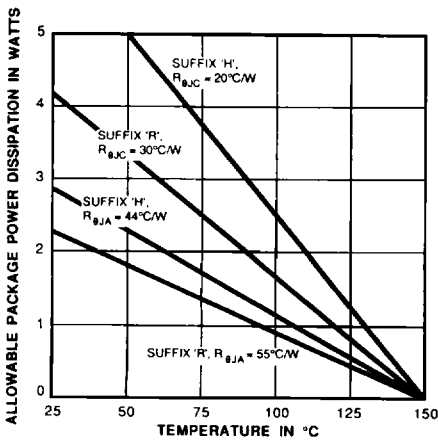
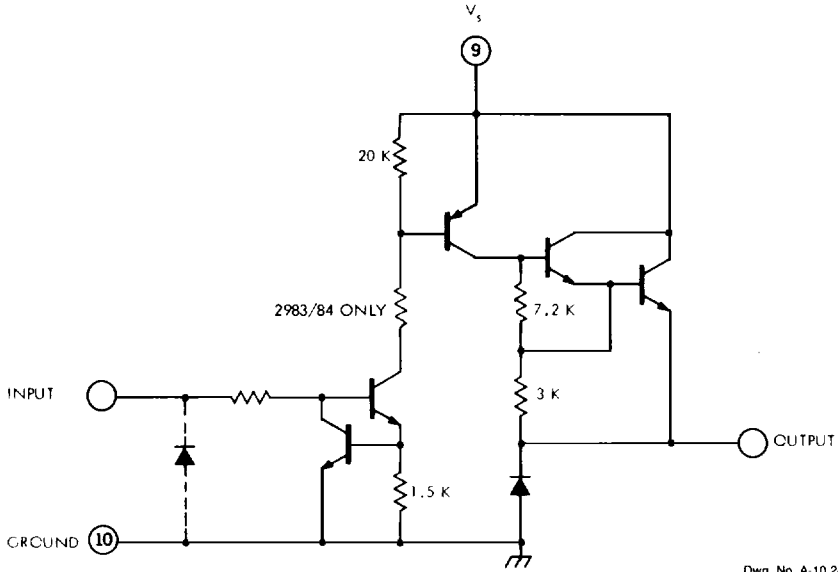

Dwg. GM 003

Device Type	$V_{CE(\text{MAX})}$	$V_{IN(\text{MAX})}$	Applications
UDS2981H/R	50 V	15 V	TTL, DTL, 5 V CMOS
UDS2982H/R	50 V	30 V	6-15 V CMOS/PMOS
UDS2983H/R	80 V	15 V	TTL, DTL, 5 V CMOS
UDS2984H/R	80 V	30 V	6-15 V CMOS/PMOS

SERIES 2980

HIGH-VOLTAGE, HIGH-CURRENT SOURCE DRIVERS

ELECTRICAL CHARACTERISTICS from -55°C to +125°C (unless otherwise specified).

Characteristic	Symbol	Applicable Devices†	Temp.	Test Conditions	Fig.	Limit
Maximum Output Leakage Current	I_{CEX}	UDS2981/82		$V_{IN} = 0.25\text{ V}^*$, $V_S = 50\text{ V}$	1	200 μA
		UDS2983/84		$V_{IN} = 0.25\text{ V}^*$, $V_S = 80\text{ V}$	1	200 μA
Maximum Collector-Emitter Saturation Voltage	$V_{CE(SAT)}$	UDS2981/83	-55°C	$V_{IN} = 2.4\text{ V}$, $I_{OUT} = -100\text{ mA}$	2	2.0 V
				$V_{IN} = 2.4\text{ V}$, $I_{OUT} = -200\text{ mA}$	2	2.1 V
			+25°C	$V_{IN} = 2.4\text{ V}$, $I_{OUT} = -350\text{ mA}$	2	2.0 V
			+125°C	$V_{IN} = 2.4\text{ V}$, $I_{OUT} = -100\text{ mA}$	2	1.8 V
		$V_{IN} = 2.4\text{ V}$, $I_{OUT} = -200\text{ mA}^{**}$		2	1.9 V	
		UDS2982/84	-55°C	$V_{IN} = 5.0\text{ V}$, $I_{OUT} = -100\text{ mA}$	2	2.0 V
				$V_{IN} = 5.0\text{ V}$, $I_{OUT} = -200\text{ mA}$	2	2.1 V
			+25°C	$V_{IN} = 5.0\text{ V}$, $I_{OUT} = -350\text{ mA}$	2	2.0 V
+125°C	$V_{IN} = 5.0\text{ V}$, $I_{OUT} = -100\text{ mA}$		2	1.8 V		
	$V_{IN} = 5.0\text{ V}$, $I_{OUT} = -200\text{ mA}^{**}$	2	1.9 V			
Maximum Input Current	$I_{IN(ON)}$	All		$V_{IN} = 2.4\text{ V}$	3	295 μA
				$V_{IN} = 3.85\text{ V}$	3	600 μA
				$V_{IN} = 12\text{ V}$	3	2.3 mA
	$I_{IN(OFF)}$	UDS2981/82		$V_{IN} = 0\text{ V}$, $V_S = 50\text{ V}$	3	10 μA
		UDS2983/84		$V_{IN} = 0\text{ V}$, $V_S = 80\text{ V}$	3	10 μA
Minimum Output Source Current	I_{OUT}	UDS2981/83		$V_{IN} = 2.4\text{ V}$, $V_{CE} = 2.2\text{ V}$	2	-200 mA
		UDS2982/84		$V_{IN} = 5.0\text{ V}$, $V_{CE} = 2.2\text{ V}$	2	-200 mA
Maximum Supply Current (Outputs Open)	I_S	UDS2981	+25°C	$V_{IN} = 2.4\text{ V}^*$, $V_S = 50\text{ V}$	4	10 mA
		UDS2982		$V_{IN} = 5.0\text{ V}^*$, $V_S = 50\text{ V}$	4	10 mA
		UDS2983		$V_{IN} = 2.4\text{ V}^*$, $V_S = 80\text{ V}$	4	10 mA
		UDS2984		$V_{IN} = 5.0\text{ V}^*$, $V_S = 80\text{ V}$	4	10 mA
Maximum Turn-ON Delay Time	t_{pHL}	UDS2981/82	+25°C	$V_S = 35\text{ V}$, $R_L = 175\ \Omega$	7	2.0 μs
		UDS2983/84		$V_S = 50\text{ V}$, $R_L = 250\ \Omega$	7	2.0 μs
Maximum Turn-OFF Delay Time	t_{pLH}	UDS2981/82	+25°C	$V_S = 35\text{ V}$, $R_L = 175\ \Omega$	7	10 μs
		UDS2983/84		$V_S = 50\text{ V}$, $R_L = 250\ \Omega$	7	10 μs
Maximum Clamp Diode Leakage Current	I_R	UDS2981/82		$V_{IN} = 0.25\text{ V}^*$, $V_S = 50\text{ V}$	5	50 μA
		UDS2983/84		$V_{IN} = 0.25\text{ V}^*$, $V_S = 80\text{ V}$	5	50 μA
Maximum Clamp Diode Forward Voltage	V_F	ALL		$I_F = 200\text{ mA}$	6	1.75 V

*All inputs simultaneously.

**Pulsed test.

†Complete part number includes a terminal letter that indicates package (H = ceramic/metal side-brazed, R = ceramic/glass cer-DIP).

SERIES 2980 HIGH-VOLTAGE, HIGH-CURRENT SOURCE DRIVERS

TEST FIGURES

Figure 1

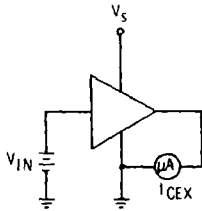

Dwg. No. A-11,083

Figure 2

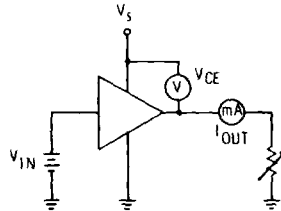

Dwg. No. A-11,084

Figure 3

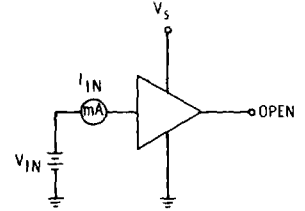

Dwg. No. A-11,085

Figure 4

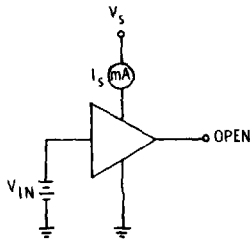

Dwg. No. A-11,086

Figure 5

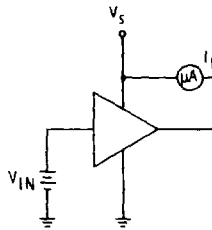

Dwg. No. A-11,087

Figure 6

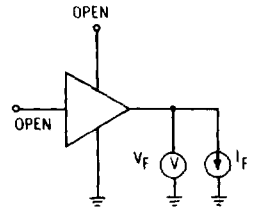

Dwg. No. A-11,088

Figure 7

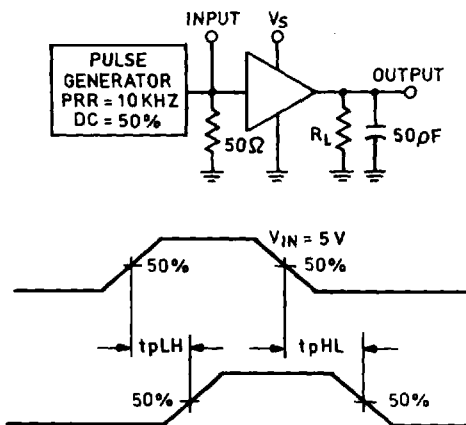

Dwg. No. A-13,26A

INPUT CURRENT AS A FUNCTION OF INPUT VOLTAGE

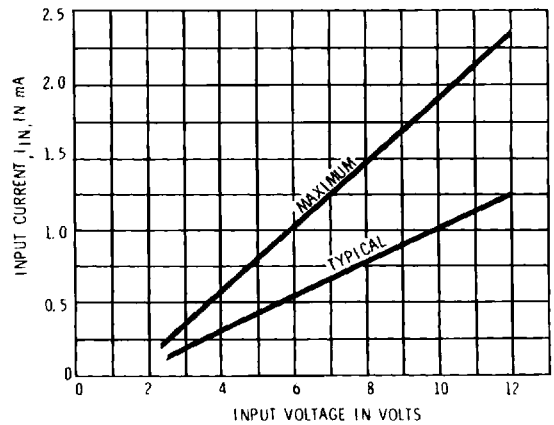

Dwg. No. A-11,111

SERIES 2980

HIGH-VOLTAGE, HIGH-CURRENT SOURCE DRIVERS

RECOMMENDED PEAK COLLECTOR CURRENT AS A FUNCTION OF DUTY CYCLE SERIES UDS2980H

UDS2981/82H

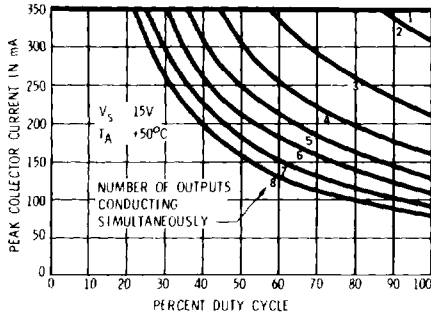

Dwg. No. A-11.078B

UDS2981/82H

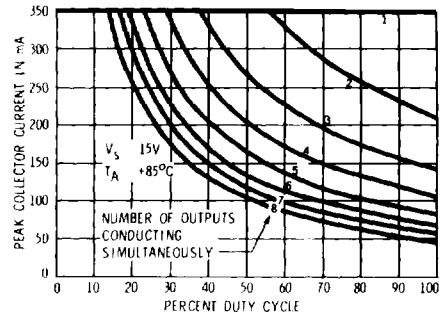

Dwg. No. A-11.076B

ALL DEVICES

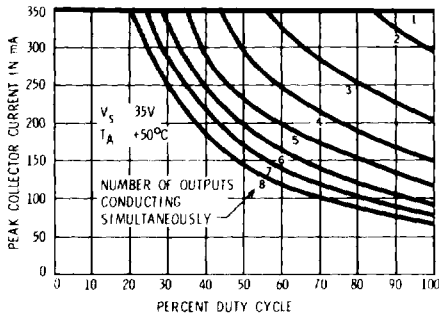

Dwg. No. A-11.079B

ALL DEVICES

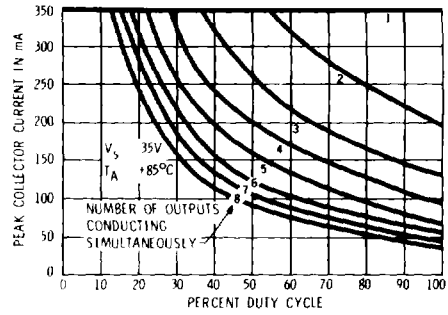

Dwg. No. A-11.080B

UDS2983/84H

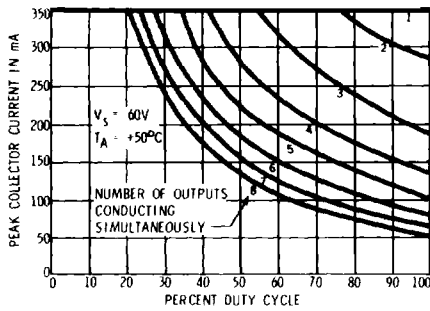

Dwg. No. A-11.077A

UDS2983/84H

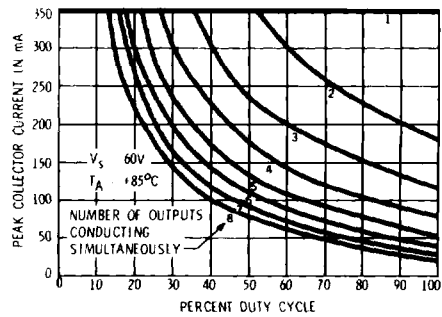

Dwg. No. A-11.081A

SERIES 2980

HIGH-VOLTAGE, HIGH-CURRENT SOURCE DRIVERS

MIL-STD-883 COMPLIANT

RECOMMENDED PEAK COLLECTOR CURRENT AS A FUNCTION OF DUTY CYCLE

SERIES UDS2980R

UDS2981/82R

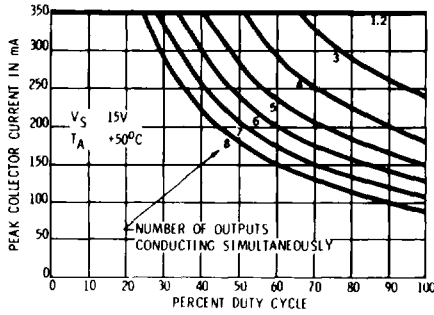

Dwg. No. A-12.401

UDS2981/82R

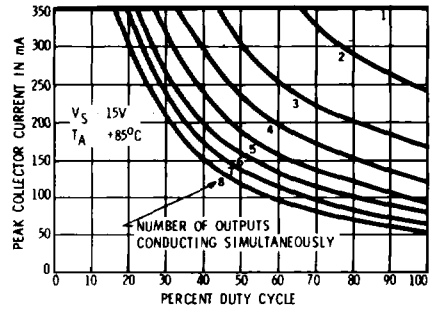

Dwg. No. A-12.402

ALL DEVICES

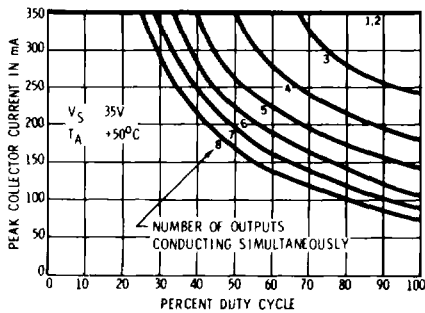

Dwg. No. A-12.403

ALL DEVICES

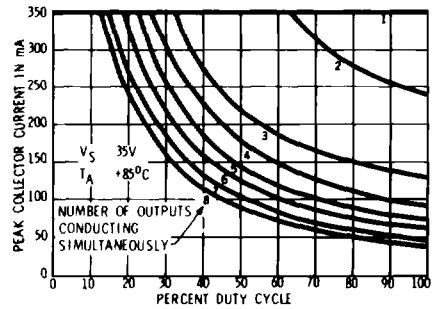

Dwg. No. A-12.404

UDS2983/84R

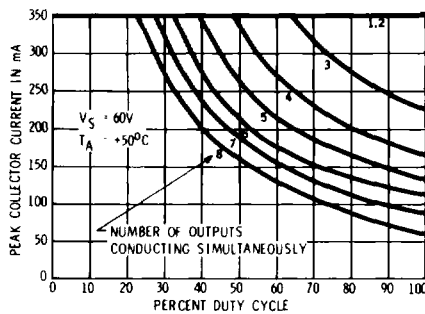

Dwg. No. A-12.405

UDS2983/84R

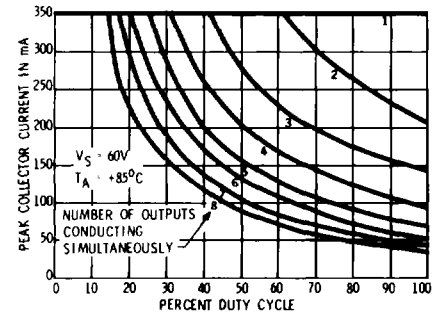

Dwg. No. A-12.406