

2.54mm Power Connectors

TCP-0XX

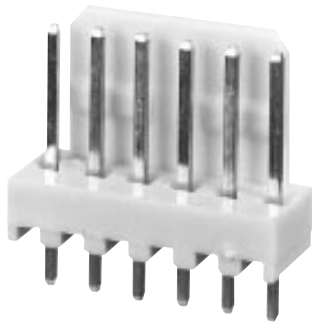

TCP-006 (shown)

XX = Number of Circuits
Available in 2-20 Circuits

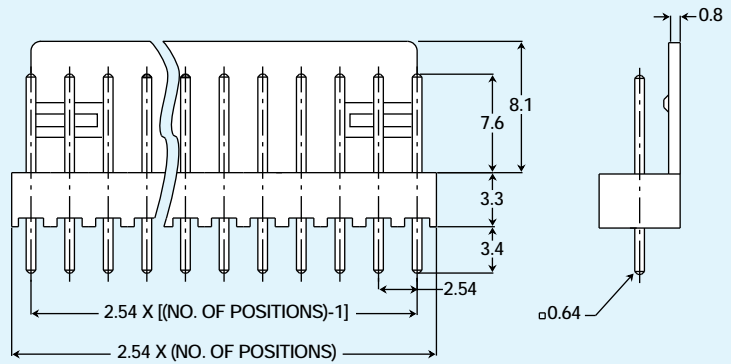

TRP-0XX



TRP-006 (shown)

XX = Number of Circuits
Available in 2-20 Circuits

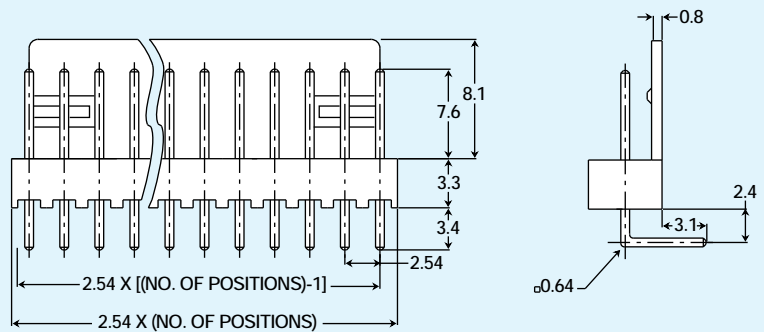

TCC-0XX

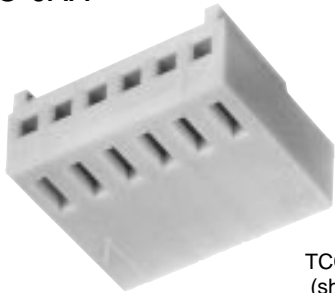

TCC-006 (shown)

XX = Number of Circuits
Available in 2-20 Circuits

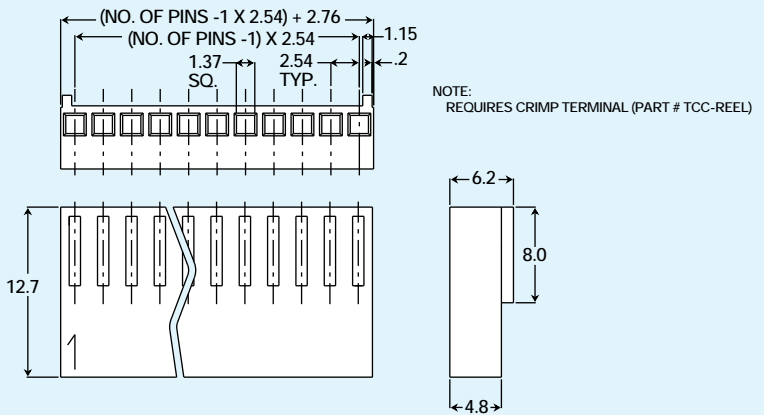

TCC-REEL

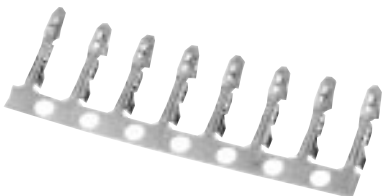

See page 322 for Crimp Tool.

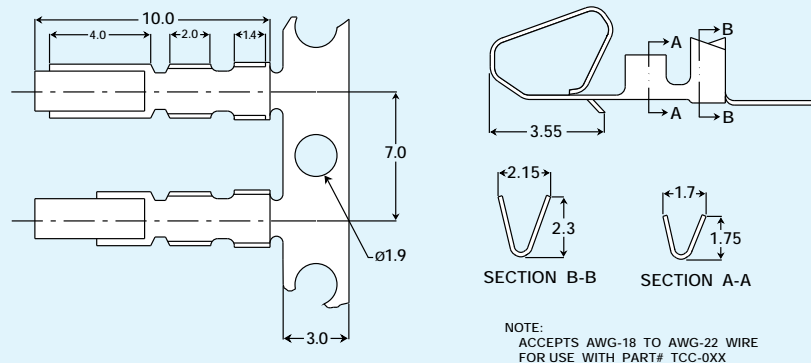

Specifications subject to change without notice. Dimensions in mm.

