

6 Watt Single Series DC/DC Converters



Features

- Low Profile Copper Case (0.375" High)
- Six-Sided Shielded Case
- Low Input/Output Noise Operation
- 500 VDC Minimum Input to Output Isolation
- Output Overvoltage Clamp
- Fixed Frequency Operation Independent of Line and Load
- Highly Regulated/Low Drift Output
- Rugged High Speed MOSFET Power Chopper
- 5 Year Warranty

Description

These 6 Watt Single Output DC/DC converters are suitable for telecommunications and industrial control applications that call for direct PCB mounting.

The converters in this series are designed with an LC input filter, a MOSFET push-pull power chopper, and an isolation transformer. A linear post regulator provides excellent line and load regulation.

Noise is reduced by housing each unit in a six-sided shielded copper case. The CALEX 5 Year Warranty covers all converters in this series.

Selection Chart

Model	Input Range VDC		Output VDC	Output mA
	Min	Max		
12S5.1000	11.16	13.20	5.0	1000
12S12.500	11.16	13.20	12.0	500
12S15.400	11.16	13.20	15.0	400
24S5.1000	22.32	26.40	5.0	1000
24S12.500	22.32	26.40	12.0	500
24S15.400	22.32	26.40	15.0	400
28S5.1000	26.04	30.80	5.0	1000
28S12.500	26.04	30.80	12.0	500
28S15.400	26.04	30.80	15.0	400
48S5.1000	44.64	52.80	5.0	1000
48S12.500	44.64	52.80	12.0	500
48S15.400	44.64	52.80	15.0	400

6 Watt Single Output Series Block Diagram

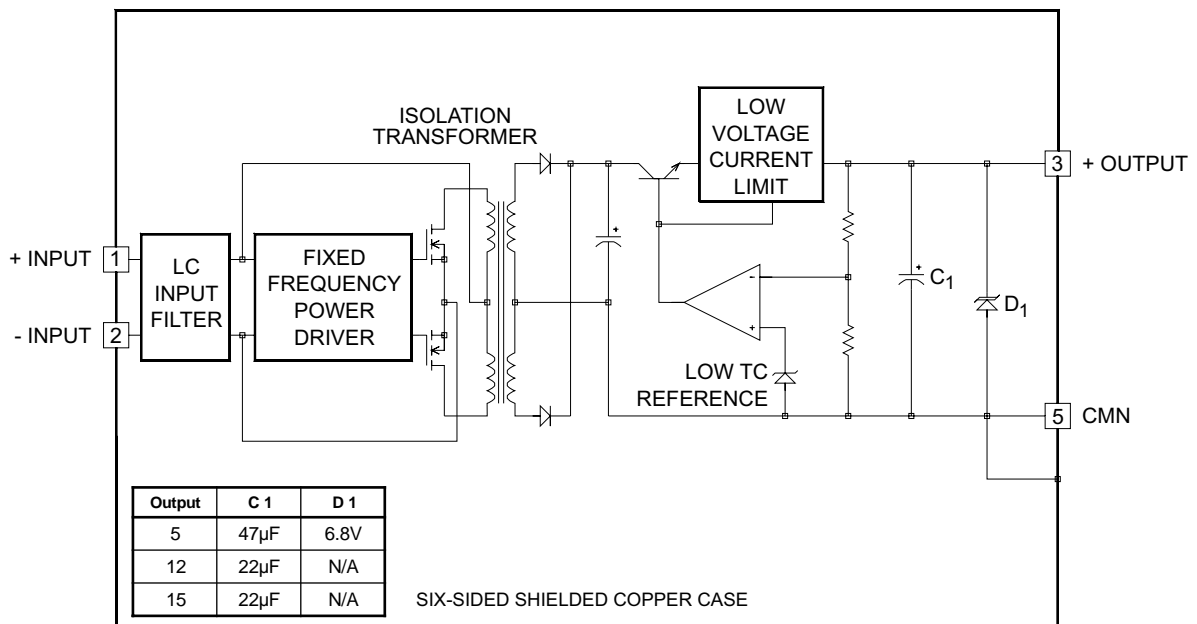

6 Watt Single Series DC/DC Converters

Input Parameters*								
Model		12S5.1000	12S12.500	12S15.400	24S5.1000	24S12.500	24S15.400	Units
Voltage Range (13)	MIN	11.16			22.32			VDC
	MAX	13.20			26.40			
Reflected Ripple (2), 0-20MHz bw	TYP	7			5			mA P-P
	MAX	15			10			
Input Current Full Load No Load	TYP	700	740	720	330	370	360	mA
	TYP	43	43	54	20	23	27	
Efficiency	TYP	60	68	69	63	68	69	%
Switching Frequency	TYP	55						kHz
Maximum Input Overvoltage, 100ms No Damage	MAX	15			30			VDC
Turn-on Time, 1% Output Error (3)	TYP	1						ms
Recommended Fuse	Slow Blow Type (4)							
Model		28S5.1000	28S12.500	28S15.400	48S5.1000	48S12.500	48S15.400	Units
Voltage Range	MIN	26.04			44.64			VDC
	MAX	30.80			52.80			
Reflected Ripple (2), 0-20MHz bw	TYP	3			10			mA P-P
	MAX	10			20			
Input Current Full Load No Load	TYP	288	318	309	170	190	185	mA
	TYP	19	19	21	16	16	17	
Efficiency	TYP	62	67	69	60	66	68	%
Switching Frequency	TYP	55						kHz
Maximum Input Overvoltage, 100ms No Damage	MAX	35			60			VDC
Turn-on Time, 1% Output Error (3)	TYP	1						ms
Recommended Fuse	Slow Blow Type (4)							

Output Parameters*								
Model		12S5.1000	24S5.1000	12S12.500	24S12.500	12S15.400	24S15.400	Units
		28S5.1000	48S5.1000	28S12.500	48S12.500	28S15.400	48S15.400	
Output Voltage		5		12		15		VDC
Rated Load (5)	MIN	0		0		0		mA
	MAX	1000		500		400		
Voltage Range 100% Load	MIN	4.95		11.90		14.90		VDC
	TYP	5.00		12.00		15.00		
	MAX	5.05		12.10		15.10		
Load Regulation 0-100% Load	TYP	0.02						%
	MAX	0.15						
Line Regulation Vin = Min-Max VDC	TYP	0.02						%
	MAX	0.10						
Short Term Stability (6)	TYP	0.02						%
Long Term Stability	TYP	0.20						%/kHrs
Transient Response (7)	TYP	20						µs
Dynamic Response (8)	TYP	120		55		50		mV peak
Input Ripple Rejection (9)	TYP	60						dB
Noise, 0-20MHz bw (2)	TYP	10						mV P-P
	MAX	40						
Temperature Coefficient	TYP	50						ppm/°C
	MAX	200						
Overvoltage Clamp (10)	TYP	6.8		-		-		VDC
Short Circuit Protection to Common for all Outputs	Short Term, 1 Minute Maximum (4)							

NOTES

- * All parameters measured at Tc=25°C, nominal input voltage and full rated load unless otherwise noted. Refer to the CALEX Application Notes for the definition of terms, measurement circuits and other information.
- (2) Noise is measured per CALEX Application Notes.
- (3) Turn-on time is defined as the time from the application of power until the output is within 1% of its final value.
- (4) For long term short circuit protection of the converters, install a slow blow fuse in the input circuit. Choose a fuse size that is 125% of your applications actual input current and does not exceed 115% of the full load input current.
- (5) No minimum load required.
- (6) Short term stability is specified after a 30 minute warm-up at full load, and with constant line, load and ambient conditions.

6 Watt Single Series DC/DC Converters

General Specifications*			
All Models			Units
Isolation			
Isolation Voltage 10µA Leakage Input-Output	MIN	700	VDC
Input to Output Capacitance	TYP	75	pF
Environmental			
Case Operating Range No Derating	MIN MAX	-25 80	°C
Case Functional Range (11)	MIN MAX	-40 85	°C
Storage Range	MIN MAX	-55 90	°C
Thermal Impedance (12)	TYP	10	°C/Watt
General			
Unit Weight	TYP	1.7	oz
Chassis Mounting Kits		MS6, MS8, MS15	

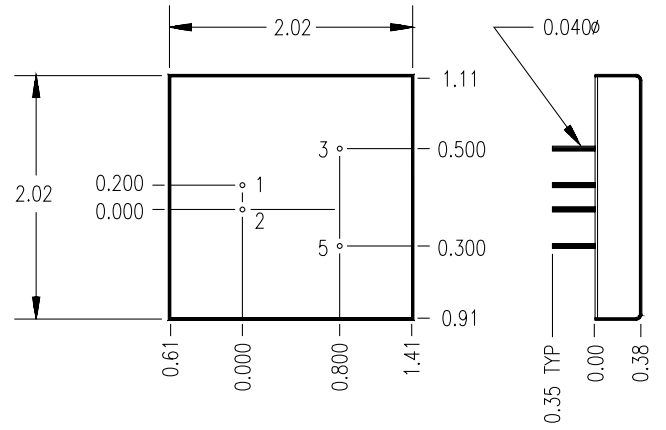

BOTTOM VIEW

SIDE VIEW

Mechanical tolerances unless otherwise noted:

X.XX dimensions: ±0.020 inches

X.XXX dimensions: ±0.005 inches

Seal around terminals is not hermetic. Do not immerse units in any liquid.

Pin	Function
1	+INPUT
2	-INPUT
3	+OUTPUT
5	CMN

- (7) After a 100% step change of the load, the output voltage will be within 1% of the final value within the transient response time.
- (8) Dynamic response is the peak overshoot voltage during the transient response time defined in note 7 above.
- (9) The input ripple rejection is specified for DC to 120Hz ripple with a modulation amplitude of 1% V_{in} .
- (10) For module protection only, see also Note 4.
- (11) The functional temperature range is intended to give an additional data point for use in evaluating this power supply. At the low functional temperature the power supply will function with no side effects, however sustained operation at the high functional temperature will reduce expected operational life. The data sheet specifications are not guaranteed over the functional temperature range.

- (12) The Case Thermal Impedance is specified as the case temperature rise over ambient per package watt dissipated.
- (13) Input voltage range is 10.56 - 15.60 VDC when total output power is 3 watts or less.
- (14) Specifications subject to change without notice.

Typical Performance: ($T_c = 25^\circ\text{C}$; Full Rated Load).

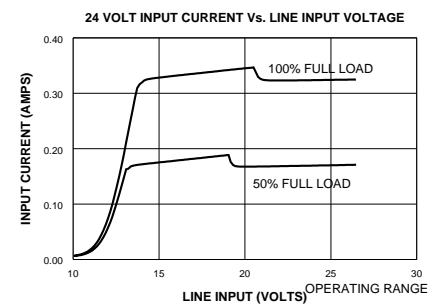
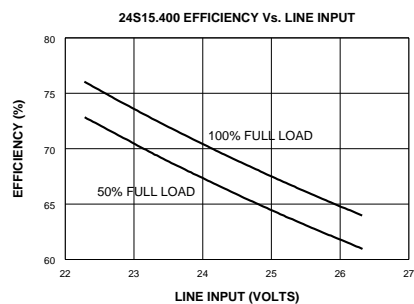
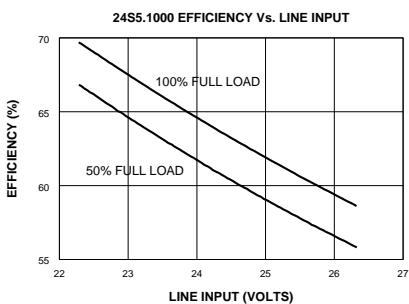
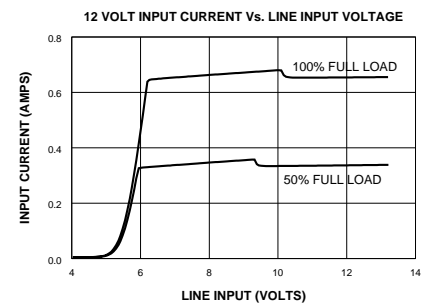
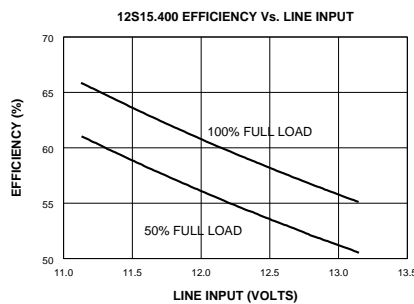
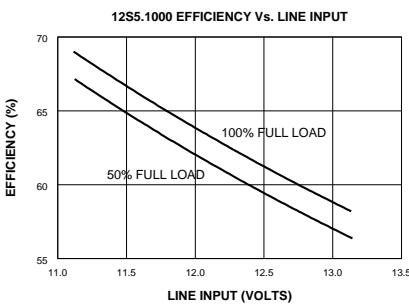

6 Watt Single Series DC/DC Converters

Typical Performance: (Tc = 25°C; Full Rated Load).

