

Agilent MSA-0311 Cascadable Silicon Bipolar MMIC Amplifier

Data Sheet

Description

The MSA-0311 is a low cost silicon bipolar Monolithic Microwave Integrated Circuit (MMIC) housed in the surface mount plastic SOT-143 package. This MMIC is designed for use as a general purpose 50 Ω gain block. Typical applications include narrow and broad band IF and RF amplifiers in commercial and industrial applications.

The MSA-series is fabricated using Agilent's 10 GHz f_T , 25 GHz f_{MAX} , silicon bipolar MMIC process which uses nitride self-alignment, ion implantation, and gold metallization to achieve excellent performance, uniformity and reliability. The use of an external bias resistor for temperature and current stability also allows bias flexibility.

SOT-143 Package

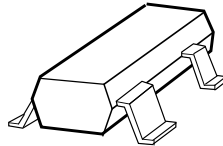

Features

- Cascadable 50 Ω Gain Block
- 3 dB Bandwidth:
DC to 2.3 GHz
- 11.0 dB Typical Gain at
1.0 GHz
- 9.0 dBm Typical $P_{1\text{ dB}}$ at
--1.0 GHz
- Unconditionally Stable
($k > 1$)
- Low Cost Surface Mount
Plastic Package
- Tape-and-Reel Packaging
Option Available
- Lead-free Option Available

Typical Biasing Configuration

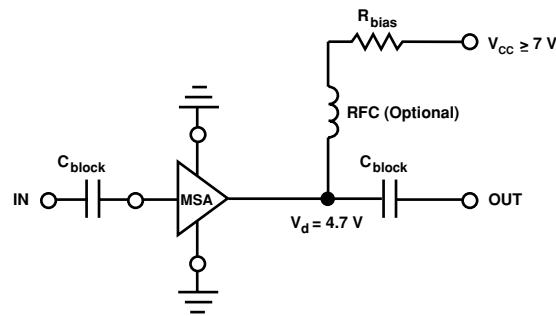

MSA-0311 Absolute Maximum Ratings

Parameter	Absolute Maximum ^[1]
Device Current	60 mA
Power Dissipation ^[2,3]	240 mW
RF Input Power	+13 dBm
Junction Temperature	150°C
Storage Temperature	-65 to 150°C

Thermal Resistance^[2]:

$$\theta_{jc} = 500^{\circ}\text{C}/\text{W}$$

Notes:

1. Permanent damage may occur if any of these limits are exceeded.
2. $T_{\text{CASE}} = 25^{\circ}\text{C}$.
3. Derate at 2.0 mW/°C for $T_{\text{C}} > 30^{\circ}\text{C}$.

Electrical Specifications^[1], $T_{\text{A}} = 25^{\circ}\text{C}$

Symbol	Parameters and Test Conditions: $I_{\text{d}} = 35 \text{ mA}$, $Z_{\text{o}} = 50 \Omega$	Units	Min.	Typ.	Max.
G_{P}	Power Gain ($ S_{21} ^2$) f = 0.1 GHz f = 1.0 GHz	dB	9.0	11.5 11.0	
ΔG_{P}	Gain Flatness f = 0.1 to 1.6 GHz	dB		± 0.7	
$f_{3 \text{ dB}}$	3 dB Bandwidth	GHz		2.3	
VSWR	Input VSWR f = 0.1 to 3.0 GHz			1.5:1	
	Output VSWR f = 0.1 to 3.0 GHz			1.7:1	
NF	50 Ω Noise Figure f = 1.0 GHz	dB		6.0	
$P_{1 \text{ dB}}$	Output Power at 1 dB Gain Compression f = 1.0 GHz	dBm		9.0	
IP_3	Third Order Intercept Point f = 1.0 GHz	dBm		22.0	
t_{D}	Group Delay f = 1.0 GHz	psec		140	
V_{d}	Device Voltage $T_{\text{C}} = 25^{\circ}\text{C}$	V	3.8	4.7	5.6
dV/dT	Device Voltage Temperature Coefficient	mV/°C		-8.0	

Notes:

1. The recommended operating current range for this device is 20 to 40 mA. Typical gain performance as a function of current is on the following page.

Ordering Information

Part Numbers	No. of Devices	Comments
MSA-0311-BLK	100	Bulk
MSA-0311-BLKG	100	Bulk
MSA-0311-TR1	3000	7" Reel
MSA-0311-TR1G	3000	7" Reel
MSA-0311-TR2	10000	13" Reel
MSA-0311-TR2G	10000	13" Reel

Note: Order part number with a "G" suffix if lead-free option is desired.

MSA-0311 Typical Scattering Parameters ($Z_0 = 50 \Omega$, $T_A = 25^\circ\text{C}$, $I_d = 35 \text{ mA}$)

Freq. GHz	S ₁₁		S ₂₁			S ₁₂			S ₂₂	
	Mag	Ang	dB	Mag	Ang	dB	Mag	Ang	Mag	Ang
0.1	.06	25	11.7	3.84	175	-17.9	.127	2	.24	-7
0.2	.07	31	11.7	3.83	170	-17.9	.128	3	.23	-13
0.4	.07	38	11.6	3.78	159	-17.8	.129	6	.24	-28
0.6	.07	30	11.4	3.72	149	-17.6	.132	18	.24	-40
0.8	.08	21	11.2	3.65	140	-17.3	.136	11	.24	-53
1.0	.08	10	11.0	3.56	130	-17.0	.141	13	.24	-65
1.5	.09	-32	10.4	3.31	106	-15.9	.160	17	.24	-91
2.0	.09	-105	9.5	2.99	84	-14.9	.179	16	.23	-115
2.5	.13	-151	8.5	2.66	70	-14.1	.197	19	.23	-133
3.0	.19	-176	7.4	2.35	51	-13.5	.212	15	.22	-145
3.5	.24	166	6.2	2.04	35	-13.0	.224	11	.23	-151
4.0	.27	152	5.1	1.80	20	-12.7	.232	6	.24	-151
5.0	.36	114	2.9	1.39	-6	-12.1	.250	-1	.25	-152
6.0	.50	88	0.8	1.10	-28	-11.8	.258	-8	.25	-166

Typical Performance, $T_A = 25^\circ\text{C}$

(unless otherwise noted)

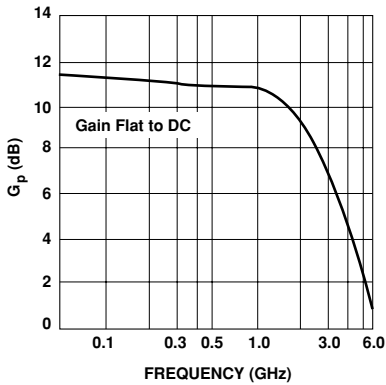

Figure 1. Typical Power Gain vs. Frequency, $I_d = 35 \text{ mA}$.

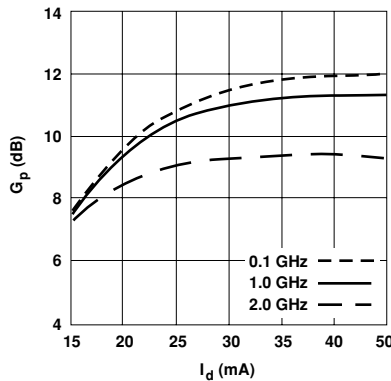

Figure 2. Power Gain vs. Current.

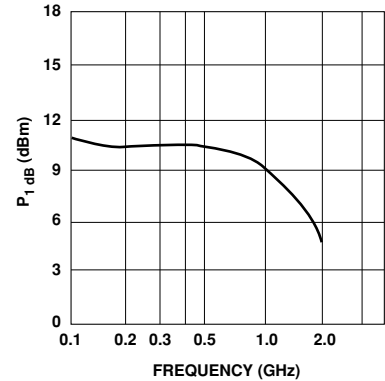

Figure 3. Output Power at 1 dB Gain Compression vs. Frequency, $I_d = 35 \text{ mA}$.

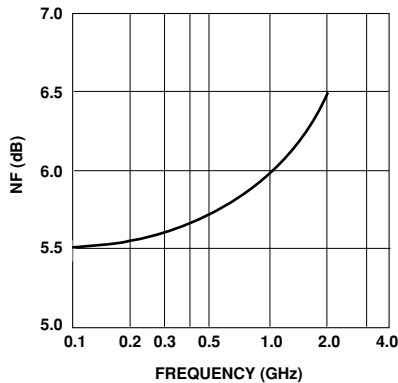
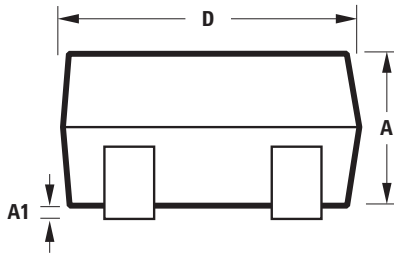
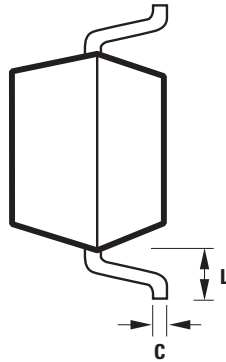
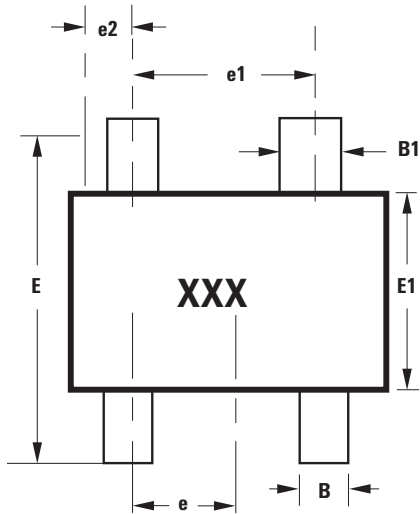

Figure 4. Noise Figure vs. Frequency, $I_d = 35 \text{ mA}$.

SOT-143 Package Dimensions



SYMBOL	DIMENSIONS (mm)	
	MIN.	MAX.
A	0.79	1.097
A1	0.013	0.10
B	0.36	0.54
B1	0.76	0.92
C	0.086	0.152
D	2.80	3.06
E1	1.20	1.40
e	0.89	1.02
e1	1.78	2.04
e2	0.45	0.60
E	2.10	2.65
L	0.45	0.69

Notes:

XXX-package marking
Drawings are not to scale

www.agilent.com/semiconductors

For product information and a complete list of distributors, please go to our web site.

For technical assistance call:

Americas/Canada: +1 (800) 235-0312 or (916) 788-6763

Europe: +49 (0) 6441 92460

China: 10800 650 0017

Hong Kong: (65) 6756 2394

India, Australia, New Zealand: (65) 6755 1939

Japan: (+81 3) 3335-8152(Domestic/International), or 0120-61-1280(Domestic Only)

Korea: (65) 6755 1989

Singapore, Malaysia, Vietnam, Thailand, Philippines, Indonesia: (65) 6755 2044

Taiwan: (65) 6755 1843

Data subject to change.

Copyright © 2005 Agilent Technologies, Inc.

Obsoletes 5965-9567E

April 4, 2005

5989-2750EN



Agilent Technologies