



### FEATURES

- RoHS compliant
- 0.28μH to 1.0mH
- Up to 8A I<sub>DC</sub>
- Bobbin format
- Surface mount
- Integral EMI shield
- Compact size
- Tape and reel packaging
- UL 94V-0 materials
- J-STD-020-C reflow

### DESCRIPTION

The 4500 series is a lower profile version of our 4600 series range of bobbin-wound, shielded inductors. They are suitable for power-line filtering found in consumer electronics such as desktop computers, LED applications and GPS systems, as well as in a vast range of industrial and telecom applications including network hubs, bridges & routers, and high frequency wireless communication devices.

These surface mount inductors are extremely compact and have an integral shield, making them useful in EMI sensitive applications.

### PIN CONNECTIONS (TOP VIEW)

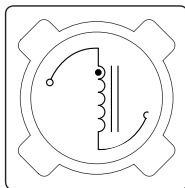

### SELECTION GUIDE

Order Code	Inductance (10kHz, 0.1V <sub>AC</sub> ) ±20%	DC Current <sup>1</sup>		DC Resistance
	Nom.	Max.	Max.	Max.
	μH	A	mΩ	
45281C	0.28 (±30%)	8.0	9	
45541C	0.54 (±30%)	7.0	11	
45102C	1.0 (±30%)	6.0	14	
45152C	1.5 (±30%)	5.5	17	
45222C	2.2 (±30%)	4.5	26	
45332C	3.3 (±30%)	3.7	34	
45472C	4.7 (±30%)	3.2	47	
45682C	6.8 (±30%)	2.6	66	
45103C	10	2.2	82	
45153C	15	1.8	120	
45223C	22	1.35	180	
45333C	33	1.25	250	
45473C	47	1.05	360	
45683C	68	0.82	510	
45104C	100	0.70	710	
45154C	150	0.58	1000	
45224C	220	0.50	1550	
45334C	330	0.35	2540	
45474C	470	0.32	3250	
45684C	680	0.26	5000	
45105C	1000	0.23	6500	

### MECHANICAL DIMENSIONS

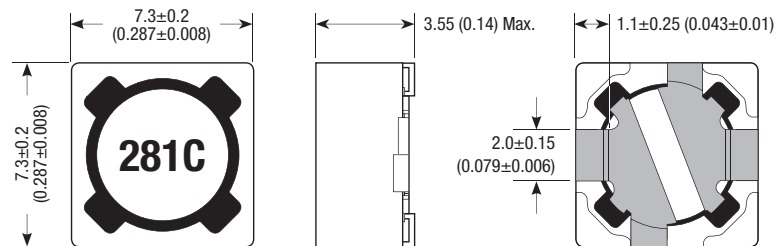

### Recommended Footprint Details\*

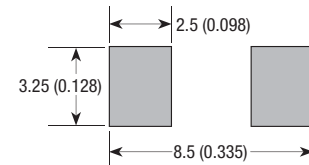

\*Distance between the outside ends of the terminations is 7.1±0.1 (0.28±0.004)  
 Unless otherwise stated, all dimensions in mm (inches) ± 0.25 (0.010).  
 Package weight: 0.64g Typ.

### ABSOLUTE MAXIMUM RATINGS

Operating temperature range	-40°C to 125°C
Storage temperature range	-40°C to 150°C

### SOLDERING INFORMATION<sup>2</sup>

Peak reflow solder temperature	250°C
Pin finish	Tin

Specifications typical at T<sub>A</sub> = 25°C

1 Maximum DC current occurs when either the inductance falls to 75% of its nominal value or when its temperature rise reaches 40°C, whichever is sooner.

2 For further information, please visit [www.murata-ps.com/rohs](http://www.murata-ps.com/rohs)



**INDUCTANCE Vs CURRENT**

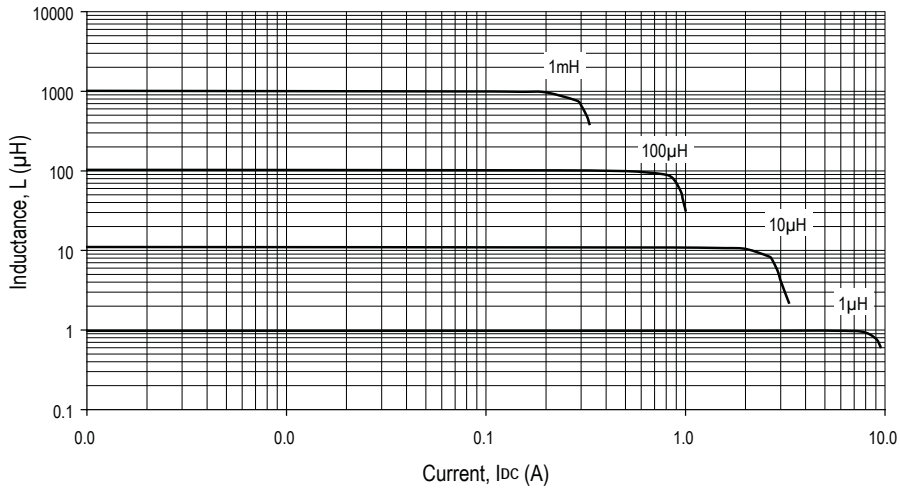

**TEMPERATURE Vs CURRENT**

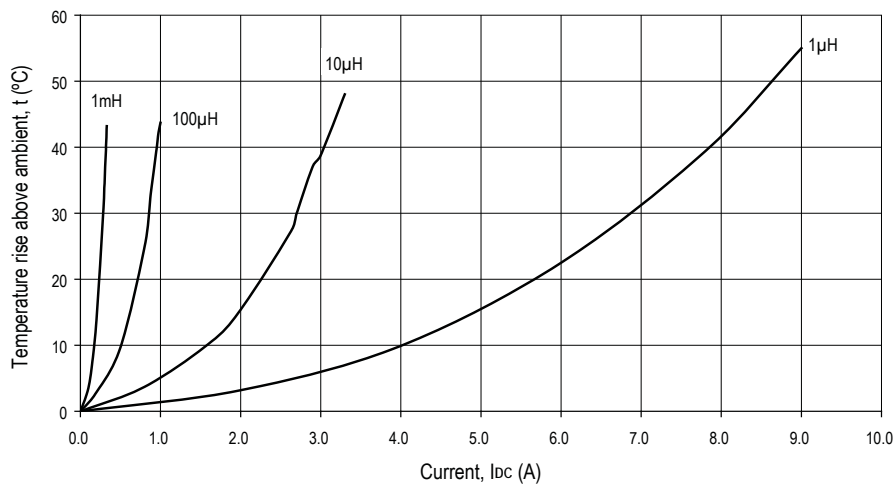

**INDUCTANCE Vs FREQUENCY**

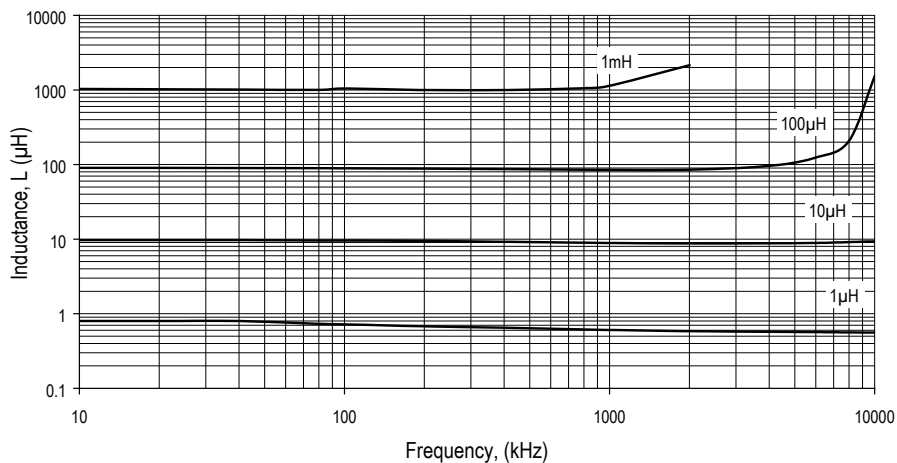

## TAPE & REEL SPECIFICATIONS

### REEL OUTLINE DIMENSIONS

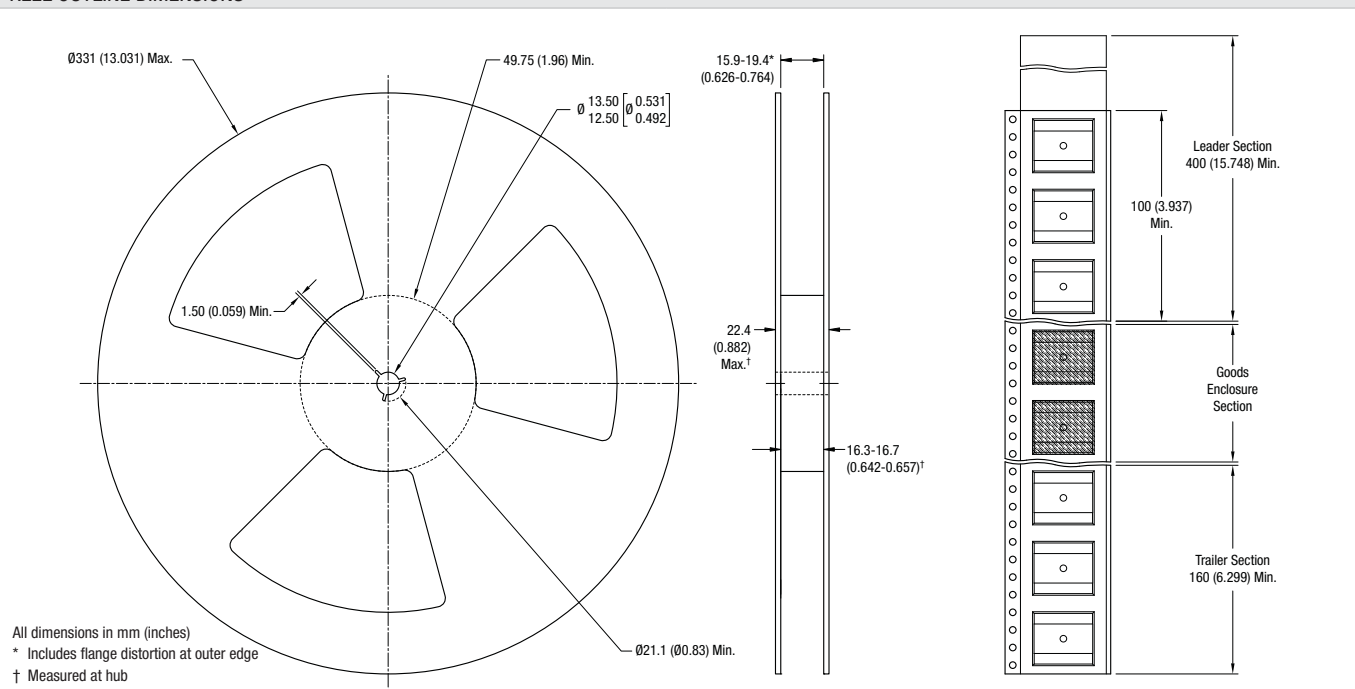

### TAPE OUTLINE DIMENSIONS

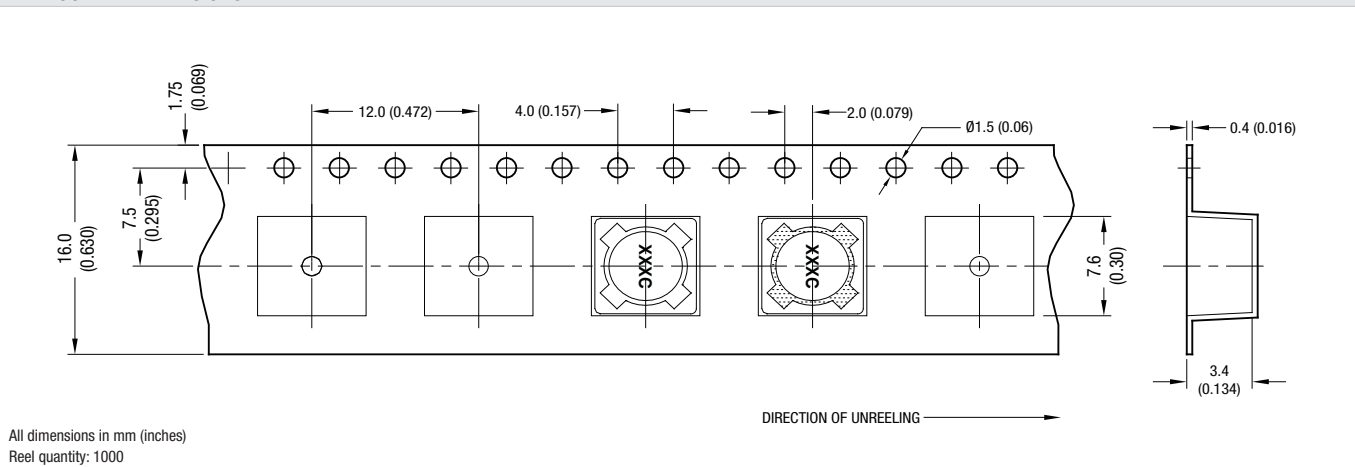

Murata Power Solutions, Inc.  
11 Cabot Boulevard, Mansfield, MA 02048-1151 U.S.A.  
ISO 9001 and 14001 REGISTERED

Murata Power Solutions, Inc. makes no representation that the use of its products in the circuits described herein, or the use of other technical information contained herein, will not infringe upon existing or future patent rights. The descriptions contained herein do not imply the granting of licenses to make, use, or sell equipment constructed in accordance therewith. Specifications are subject to change without notice.  
© 2011 Murata Power Solutions, Inc.