

■ Ribbon fiber connector

● MD series

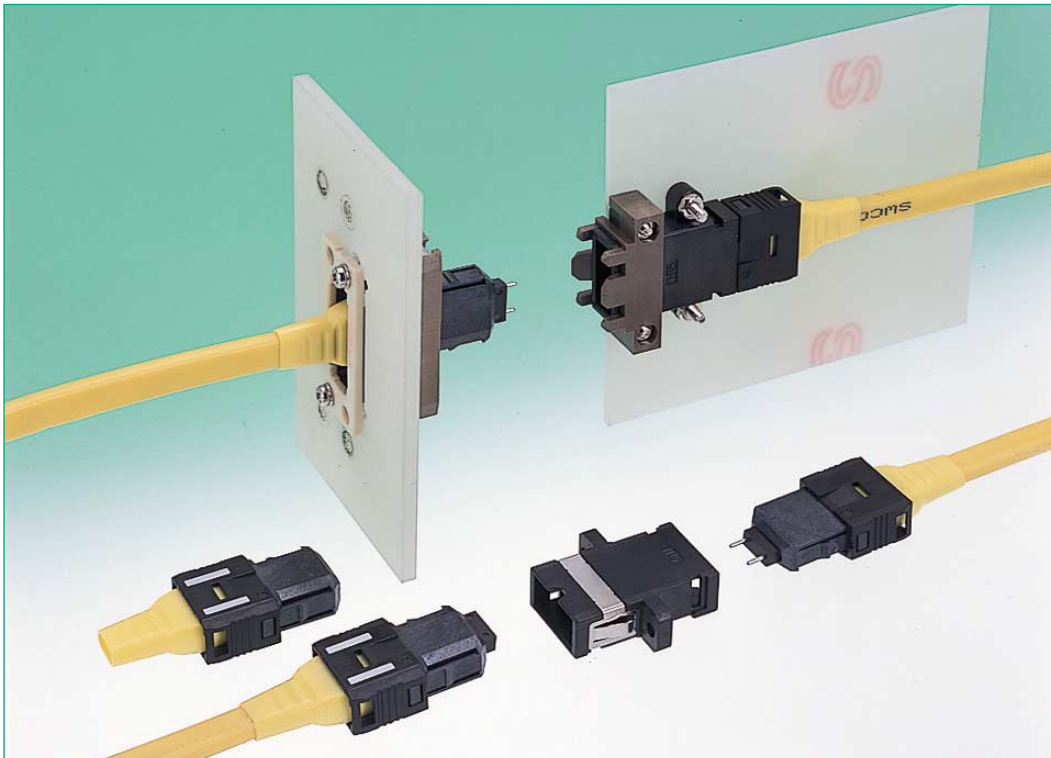

■ Features

1. Compact design.

36mm from MT ferrule end face to connector boot end.

2. User friendly push-pull mechanism.

Same push-pull operation as SC connector.

3. SM,MM 4, 8, 12 positions are available.

MD connector variation

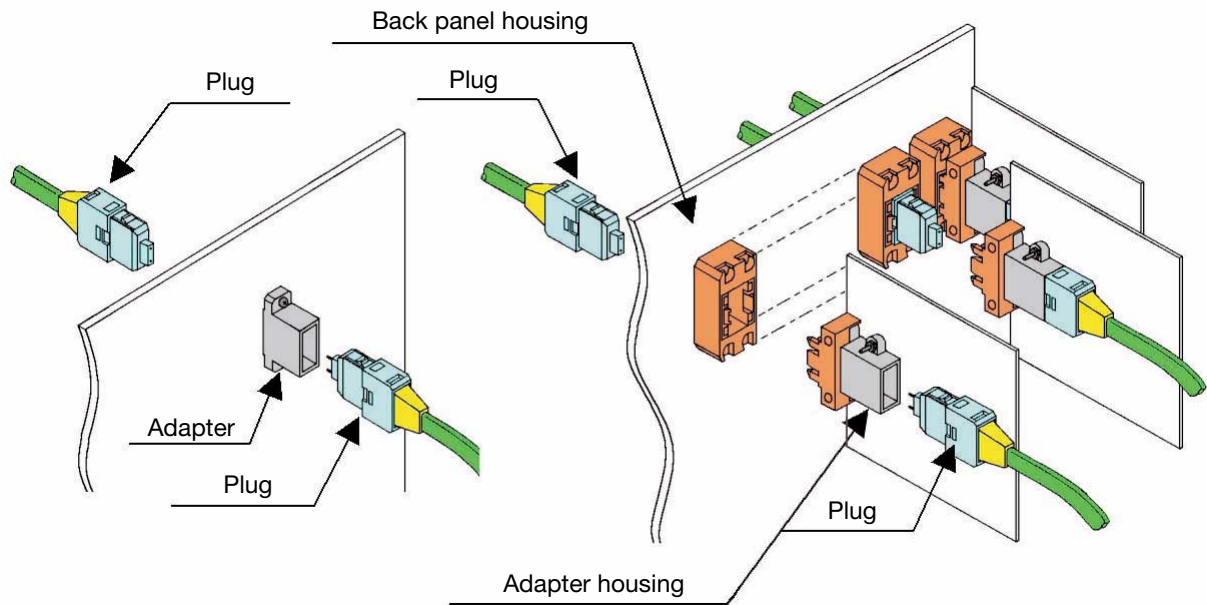

MD plug is used for both plug-Adapter-plug and backplane connection

Connection to Multi-link module.

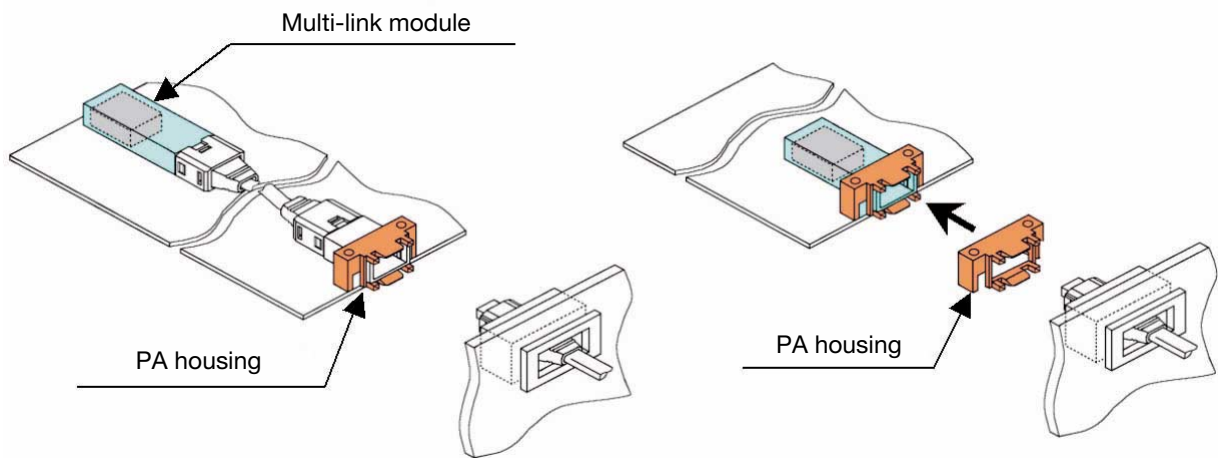

Possible direct backplane connection to Multi-link module with using PA housing.

Plug

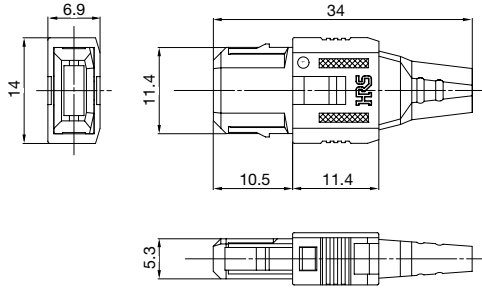

Product Number	HRS No.	Applicable Cable
HMDT4-P1-H1	CL 713-0009-9	4-way ribbon cable
HMDT8-P1-H1	CL 713-0005-8	8-way ribbon cable
HMDT12-P1-H1	CL 713-0006-0	12-way ribbon cable

Adapter

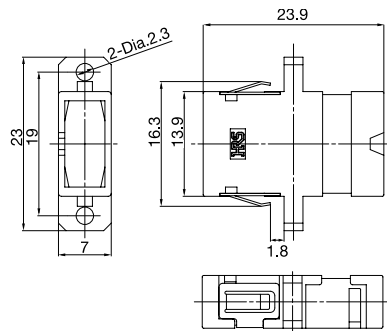
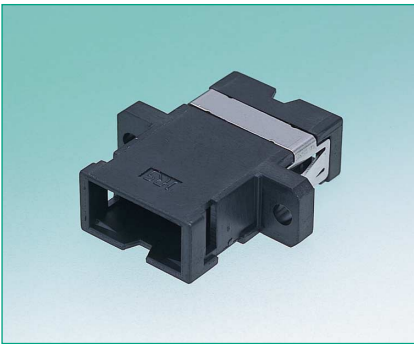

◆ Panel cutout

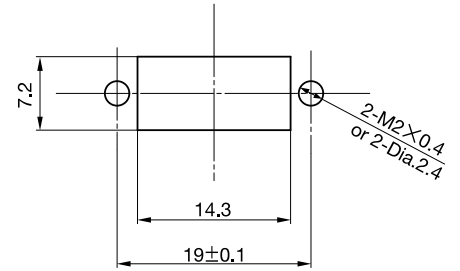

Product Number	HRS No.
HMDT-A1	CL 713-0002-0

Back Plane Connector

Back Panel Side Connector Housing

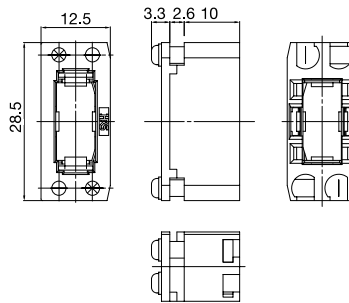
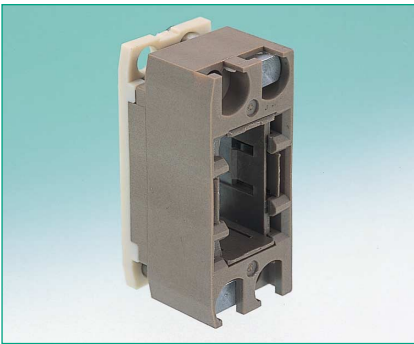

◆ Panel cutout

(view from daughter board side)

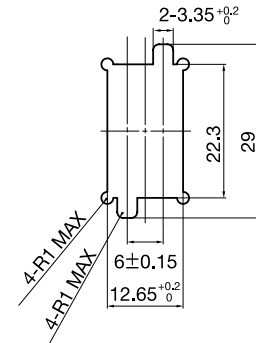

Product Number	HRS No.
HMDT-L1HA-1	CL 713-0003-2

Package Side Connector Housing

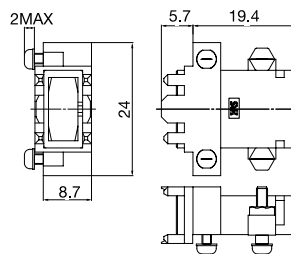

◆ Board layout

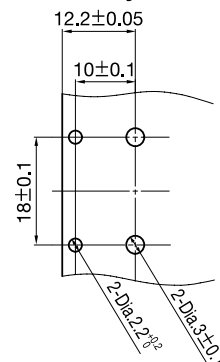

Product Number	HRS No.
HMDT-L1PA-1	CL 713-0004-5

Ribbon Fiber Connector -MD Series-

■ Tools

● Insertion/Extraction Tool



Product Number	HRS No.
HMDT/HEMD	CL 902-6037-7

● Cleaning Tool



Product Number	HRS No.
HMDT-CLN	CL 713-0010-8

● Guide pin press fit Tool

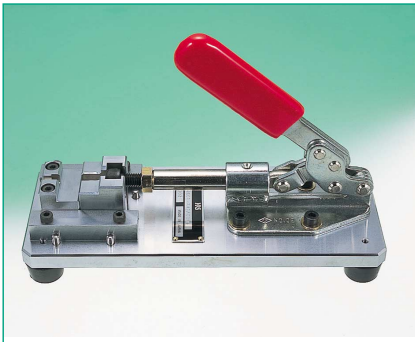

Product Number	HRS No.
HMDT/PRMD	CL 902-6036-7