

Solder-dip type with flange

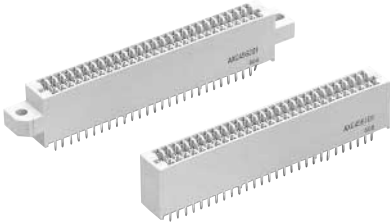

Solder-dip type without flange

FEATURES

1. Long insertion and removal life.

Thanks to our original contact shape, low insertion force is required and it is designed so that the contact position shifts at the start and end of card insertion. This reduces metal abrasion.

- Standard type: 10,000 times
- Low-insertion-force, long life type: 30,000 times

Contact shape

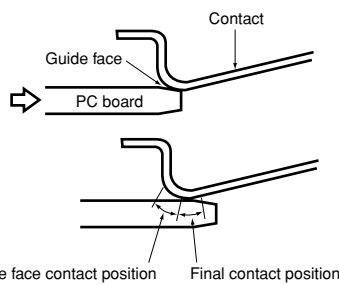

2. Low insertion types are also available.

Among solder-dip types, low insertion types are available with approximately 0.490N, 50gf/ contact and less than 1/4 of the standard connector with a good fit feel.

Insertion/removal force comparison between low insertion and standard types

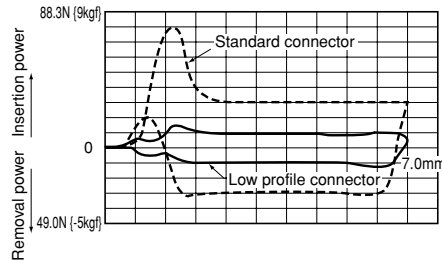

3. Incorrect or reverse insertion can be prevented.

By means of the key to prevent incorrect insertion and the slit fabrication of the printed circuit board, reverse insertion into a printed circuit board block or incorrect insertion into a similarly appearing printed circuit board block can be prevented.

4. Compliance with RoHS' Directive
Environmentally friendly, the connectors' comply with Europe's RoHS' Directive. Cadmium, lead, mercury, hexavalent, chromium, PBB and PBDE are not used.

APPLICATIONS

- Communication equipment
- Measuring equipment
- Factory automation related equipment

• What is the low-insertion/long-life type?

This connector employs a unique soft-insertion construction with a step provided in the contact. Low insertion power (less than 30% of standard connector) and long life (over 30,000 insertion/removal times) is realized.

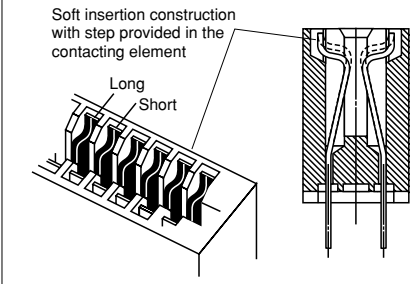

ORDERING INFORMATION

AXC

4: Card-edge connectors

<No. of contacts (2 digits)>

34: 34 contacts 36: 36 contacts 44: 44 contacts
 56: 56 contacts 60: 60 contacts 62: 62 contacts
 72: 72 contacts 86: 86 contacts 00: 100 contacts

<Mounting flange shape and type>

1: Without flange (Standard type)
 2: With flange (Standard type)
 4: Without flange (Low insertion force/Long life type)
 5: With flange (Low insertion force/Long life type)



<Terminal shape>

0: DIP straight terminal

<Surface treatment (Contact portion/Terminal portion)>

1: Au plating 0.2 μm/Sn plating (Standard type)
 3: Au plating 0.76 μm/Sn plating (Low insertion force/Long life type)

PRODUCT TABLE

Type	Standard type	Low insertion force/Long life type
	Solder-dip straight terminals	Solder-dip straight terminals
Contact pitches	2.54mm	2.54mm
Spaces between rows	5.08mm	5.43mm
No. of contacts	100	100
	86	86
	72	72
	60, 62	60, 62
	56	56
	44	44
	34, 36	34, 36
Terminal shape	 Solder-dip straight terminal	 Solder-dip straight terminal

Note) Each connector is available with or without flanges.

PRODUCT TYPES

1.Connector

• Standard type (solder-dip straight terminal)

No. of contacts	No flange type	Flange type	Packing quantity	
	Part No.	Part No.	Inner carton	Outer carton
34	AXC434101	AXC434201	—	200 pcs.
36	AXC436101	AXC436201		
44	AXC444101	AXC444201		
56	AXC456101	AXC456201		
60	AXC460101	AXC460201		
62	AXC462101	AXC462201		
72	AXC472101	AXC472201		
86	AXC486101	AXC486201		
100	AXC400101	AXC400201		

• Low insertion force/Long life type (solder-dip straight terminal)

No. of contacts	No flange type	Flange type	Packing quantity	
	Part No.	Part No.	Inner carton	Outer carton
34	AXC434403	AXC434503	—	200 pcs.
36	AXC436403	AXC436503		
44	AXC444403	AXC444503		
56	AXC456403	AXC456503		
60	AXC460403	AXC460503		
62	AXC462403	AXC462503		
72	AXC472403	AXC472503		
86	AXC486403	AXC486503		
100	AXC400403	AXC400503		

Note) The row pitch between solder-dip straight terminals of the low-insertion-power/long-life type is different from the card edge connector standard type.

Low insertion force/Long life type: 5.43mm
 Standard type: 5.08mm



2. Keys (Standard type, low insertion force and long life type)

Name	Part No.	Packing quantity	
		Inner carton	Outer carton
Incorrect insertion prevention key	AXC8001	50 pcs.	200 pcs.

SPECIFICATIONS

1. Characteristics (Standard type)

Item		Specifications	Conditions
Electrical characteristics	Rated current	3A	
	Rated voltage	250V AC	
	Breakdown voltage	1,000 V AC for 1 min.	Detection current: 1mA
	Insulation resistance	Min. 1,000MΩ	at 500V DC
	Contact resistance	Max. 20mΩ	Measured based on the HP4338B measurement method of JIS C 5402
Mechanical characteristics	Insertion force (unit)	Max. 4.45N {453.6gf}	Measured by steel gauge with 1.78mm thickness and smoothness 0.1s.
	Removal force (unit)	Min. 0.279N {28.4gf}	Measured by steel gauge with 1.37mm thickness and smoothness 0.1s after 3 times insertion of 1.78mm thickness gauge
	Holding force for contact	Min. 9.81N {1kgf}	
Life time characteristics	Insertion and removal life	10,000 times	Replace the PCB board within 2,000 times.
Environmental characteristics	Ambient temperature	-55°C to +105°C	No freezing at low temperatures
	Soldering temperature resistance	260°C: Within 10 sec.; 300°C: Within 5 sec. 350°C: Within 3 sec.	

2. Characteristics (Low insertion force/Long life type)

Item		Specifications	Conditions
Electrical characteristics	Rated current	2A	
	Rated voltage	250V AC	
	Breakdown voltage	1,000 V AC for 1 min.	Detection current: 1mA
	Insulation resistance	Min. 1,000MΩ	at 500V DC
	Contact resistance	Max. 20mΩ	Measured based on the HP4338B measurement method of JIS C 5402
Mechanical characteristics	Insertion force (Composite)	Max. 39.2N {4.0kgf} (100 contacts) Max. 28.4N {2.9kgf} (72 contacts) Max. 13.7N {1.4kgf} (34 contacts)	The contact face of the 1.6±0.15 mm PC board is gold plated. Guide portion of PC board is chamfered 15°.
	Removal force (Composite)	Min. 5.88N {0.6kgf} (100 contacts) Min. 4.21N {0.43kgf} (72 contacts) Min. 1.96N {0.2kgf} (34 contacts)	
Life time characteristics	Insertion and removal life	30,000 times	Replace the PCB board within 2,000 times.
Environmental characteristics	Ambient temperature	-55°C to +105°C	No freezing at low temperatures
	Soldering temperature resistance	260°C: Within 10 sec.; 300°C: Within 5 sec. 350°C: Within 3 sec.	

3. Material and surface treatment

Part name	Material		Surface treatment	
	Standard type	Low insertion force/Long life type	Standard type	Low insertion force/Long life type
Molded portion	Glass reinforced PBT (UL94V-0)		—	
Contact	Copper alloy		Contact portion: Ni plating on base, Au plating (0.2μm) on surface Terminal portion: Ni plating on base, Sn plating on surface	Contact portion: Ni plating on base, Au plating (0.76μm) on surface Terminal portion: Ni plating on base, Sn plating on surface

4. Applicable PC board

Standard type, low insertion force and long life type
<ul style="list-style-type: none"> Inserting PC board thickness: 1.6±0.15mm Mounting PC board thickness: 1.6 to 2.4mm Pattern pitch: 2.54±0.05mm Pattern width: 1.4mm Contact portion: Au plating

DIMENSIONS

1. Standard type

- Without flange

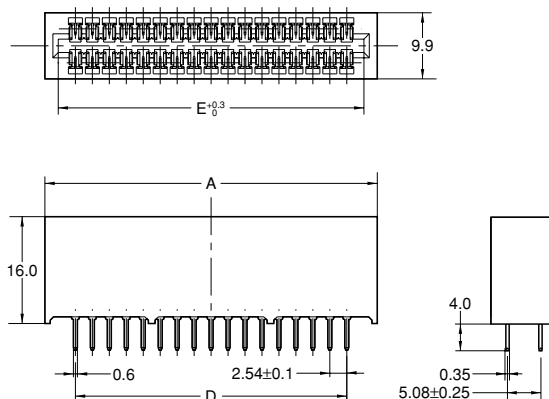

Dimension table (mm)

No. of contacts	A	D	E
34	49.78	40.64	45.78
36	52.32	43.18	48.32
44	62.48	53.34	58.48
56	77.72	68.58	73.72
60	82.8	73.66	78.8
62	85.34	76.2	81.34
72	98.04	88.9	94.04
86	115.82	106.68	111.82
100	133.6	124.46	129.6

Recommended PC board pattern (Bottom view)

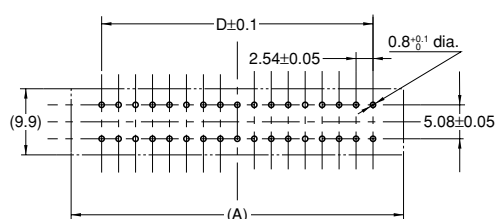

- With flange

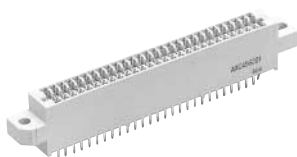

Applicable PC board dimensions

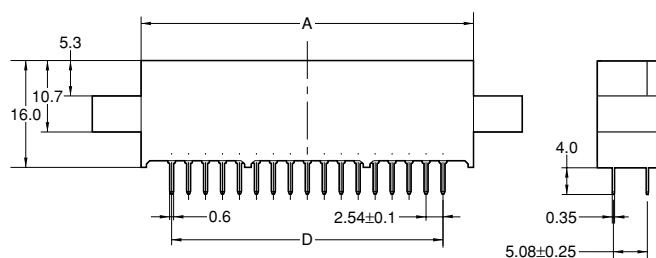
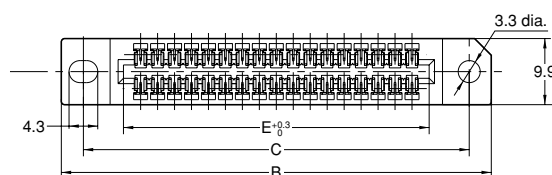
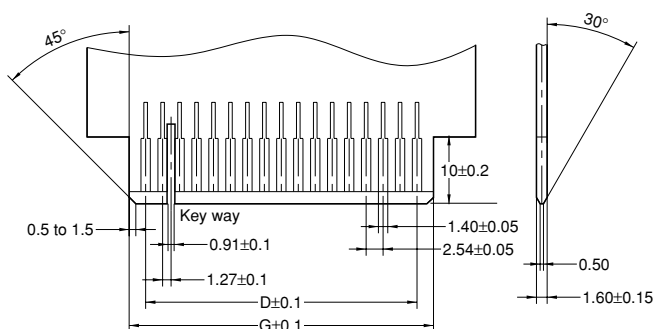

Recommended PC board pattern (Bottom view)

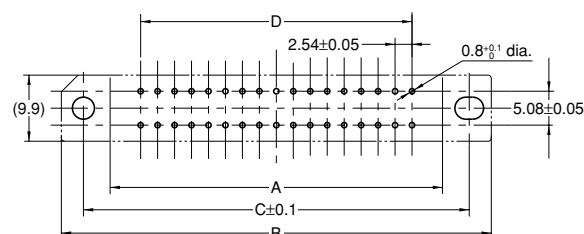

Dimension table (mm)

No. of contacts	A	B	C	D	E	G
34	49.78	64.39	57.78	40.64	45.78	45.58
36	52.32	66.93	60.32	43.18	48.32	48.12
44	62.48	77.09	70.48	53.34	58.48	58.28
56	77.72	92.33	85.72	68.58	73.72	73.52
60	82.8	97.41	90.8	73.66	78.8	78.6
62	85.34	99.95	93.34	76.2	81.34	81.14
72	98.04	112.65	106.04	88.9	94.04	93.84
86	115.82	130.43	123.82	106.68	111.82	111.62
100	133.6	148.21	141.6	124.46	129.6	129.4

Mounting hole cut-out

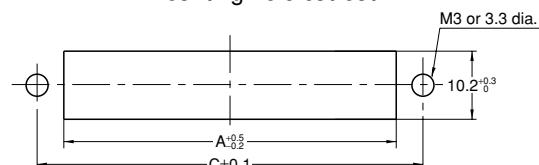

AXC

2. Low insertion force/Long life type

mm General tolerance: ± 0.3

A) With flange type

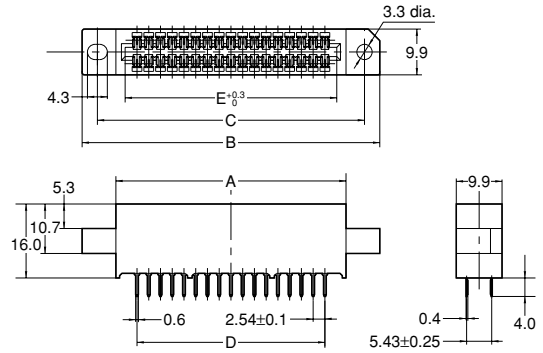
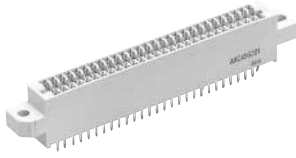

B) Without flange type

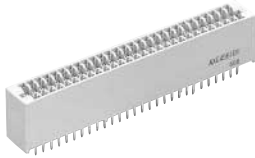

Recommended PC board pattern (Bottom view)

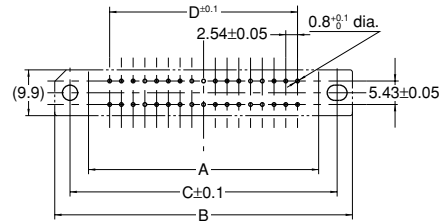

Applicable PC board dimensions

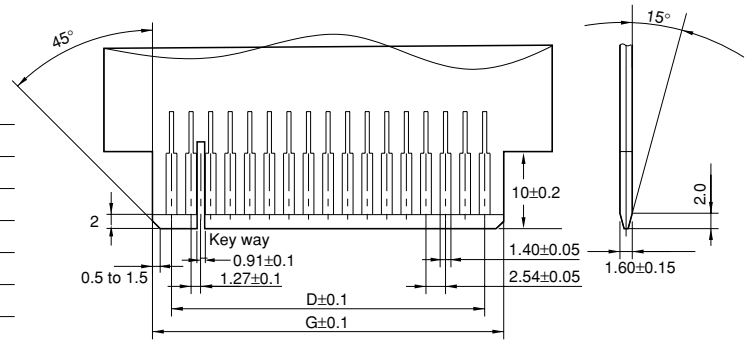

Terminal pitches are different from standard type.
 Low insertion force/Long life type : 5.43mm
 Standard type : 5.08mm

Dimension table (mm)

No. of contacts	A	B	C	D	E	G
34	49.78	64.39	57.78	40.64	45.78	45.58
36	52.32	66.93	60.32	43.18	48.32	48.12
44	62.48	77.09	70.48	53.34	58.48	58.28
56	77.72	92.33	85.72	68.58	73.72	73.52
60	82.8	97.41	90.8	73.66	78.8	78.6
62	85.34	99.95	93.34	76.2	81.34	81.14
72	98.04	112.65	106.04	88.9	94.04	93.84
86	115.82	130.43	123.82	106.68	111.82	111.62
100	133.6	148.21	141.6	124.46	129.6	129.4

Note) Dimensions of A, D, E and G are common for both types.

NOTES

1. Cautions regarding printed circuit board fabrication

1) Appropriate dimensions for the board insertion width should be provided for the connector connection section of the printed circuit board. If the clearance between the printed circuit board insertion width and that of the connector is large, defective contact or short circuit can be caused. The drawing for the printed circuit board pattern design should provide reference to the clearance as being small.

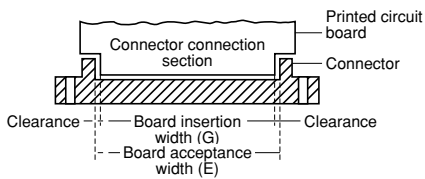

2) The pattern shift of the front and back connector connection section of the printed circuit board should be within 0.2mm.

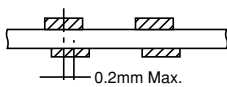

3) Bevelling should be provided without fail for the insertion width of the connector connection section. When the printed circuit board is inserted in the connector, the bevelling will keep distortion of the contacts and insertion force small, improving the insertion capability along with preventing defective contact due to dropping out of the printed circuit board end surface.

• Standard type

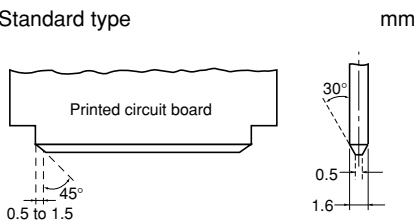

• Low insertion force/Long life type

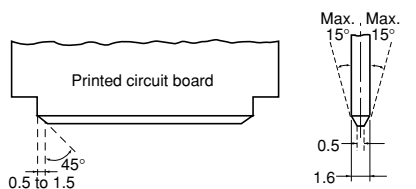

4) The proper thickness of printed circuit board should be used.

5) Care must be taken with printed circuit board "warp." The extent of the warpage may be exacerbated when the electronic components are mounted on the printed circuit board due to the contraction of the solder on the board. For this reason, ensure that the maximum warp of the area where the connector is mated is 0.1mm.

2. Regarding insertion of printed circuit board

1) Care should be taken to avoid having any oil, flux, or other foreign matter adhere to the insertion section contact surface of the printed circuit board. Foreign matter can lead to defective contact. If such a condition exists, the adhering matter should be removed with alcohol, freon, or other suitable solvent.
2) Insert into connector at least 8.2 mm from the insertion edge of the PC board.

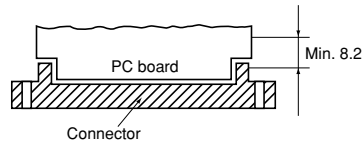

3) By means of a groove fabricated at a designated position, a key (special accessory part) is inserted for the prevention of reverse insertion or incorrect insertion of a similarly appearing printed circuit board.

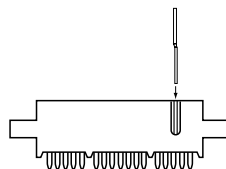
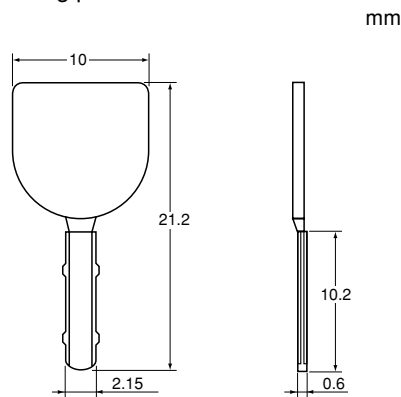

3. Regarding the operations for dip type soldering

The dip type soldering operations should be carried out under the following conditions.

- 260°C Within 10 seconds
- 300°C Within 5 seconds
- 350°C Within 3 seconds

Regarding general notes, please refer to page 12.

For other details, please verify with the product specification sheets.