



























4 Female Connectors with CAGE CLAMP®, 100 % Protected against Mismatching, Pin Spacing 5 mm / 0.197 in, Light Grey

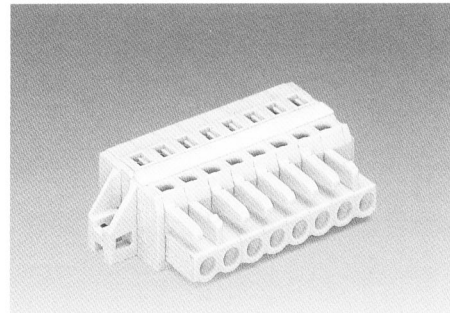
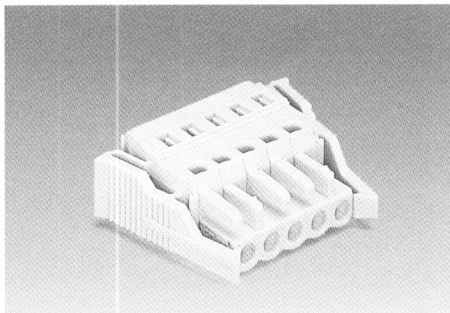
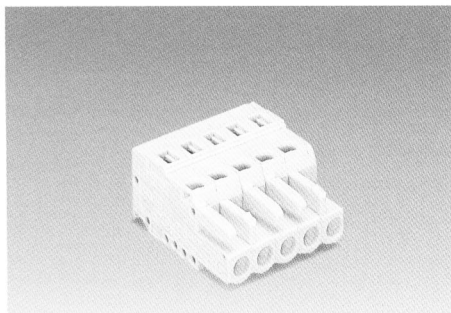









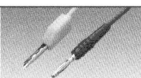

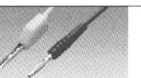
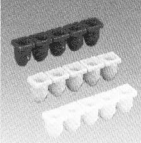
44

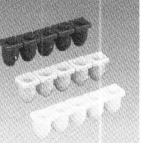
| | | |
|---|---|---|
| <p>Pin spacing 5 mm/0.197 in, light grey 0.08 – 2.5 mm² AWG 28 – 12 250 V/4 kV/3 300 V, 15 A  16 A 300 V, 15 A </p> <p> 8 – 9 mm / 0.33 in</p> <p>*    </p> | <p>Pin spacing 5 mm/0.197 in, light grey 0.08 – 2.5 mm² AWG 28 – 12 250 V/4 kV/3 300 V, 15 A  16 A 300 V, 15 A </p> <p> 8 – 9 mm / 0.33 in</p> <p>*    </p> | <p>Pin spacing 5 mm/0.197 in, light grey 0.08 – 2.5 mm² AWG 28 – 12 250 V/4 kV/3 300 V, 15 A  16 A 300 V, 15 A </p> <p> 8 – 9 mm / 0.33 in</p> <p>*    </p> |
|---|---|---|

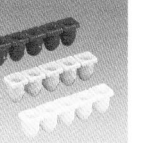

| No. of poles | Item-No. | No. of poles | Item-No. | No. of poles | Item-No. | |
|---|--|--|--|--|--|-----------------|
| Female connectors with CAGE CLAMP®, 100 % protected against mismatching, with coding fingers, with two latches, light grey | | Female connectors with CAGE CLAMP® and locking device, 100 % protected against mismatching, with coding fingers, with two latches, light grey | | Female connectors with CAGE CLAMP® and fixing fingers, for racks and feedthrough connections, 100 % protected against mismatching, with reinforcing strips, with coding fingers, with two latches, for screw or similar methods of fixing, light grey | | |
| 2 (one latch only) | 721-102/026-000 | 2 (one latch only) | 721-102/037-000 | 2 | please use the female connectors for panel mounting (item.-No. 721-102/031-000 to 721-105/031-000) see page 4.45 | |
| 3 | 721-103/026-000  | 3 | 721-103/037-000  | 3 | | |
| 4 | 721-104/026-000  | 4 | 721-104/037-000  | 4 | | |
| 5 | 721-105/026-000  | 5 | 721-105/037-000  | 5 | | |
| 6 | 721-106/026-000 | 6 | 721-106/037-000 | 6 | | 721-106/027-000 |
| : | : | : | : | : | | : |
| 10 | 721-110/026-000 | 10 | 721-110/037-000 | 10 | 721-110/027-000 | |
| 12 | 721-112/026-000 | 12 | 721-112/037-000 | 12 | 721-112/027-000 | |
| 14 | 721-114/026-000 | 14 | 721-114/037-000 | 14 | 721-114/027-000 | |
| 16 | 721-116/026-000 | 16 | 721-116/037-000 | 16 | 721-116/027-000 | |
| 20 | 721-120/026-000 | 20 | 721-120/037-000 | 20 | 721-120/027-000 | |

Accessories

| | | | | | |
|--|---|---|---|---|---|
|  | Test plug , w. cable 500 mm/1'7.7" 2 mm/0.079 in Ø, red 210-136 2.3 mm/0.091 in Ø, yel. 210-137 |  | Test plug , w. cable 500 mm/1'7.7" 2 mm/0.079 in Ø, red 210-136 2.3 mm/0.091 in Ø, yel. 210-137 |  | Test plug , w. cable 500 mm/1'7.7" 2 mm/0.079 in Ø, red 210-136 2.3 mm/0.091 in Ø, yel. 210-137 |
|  | Insulation stop , 5 pcs/strip 0.08 - 0.2 mm ²  (white) 231-670 0.25 - 0.5 mm ² (light gr.) 231-671 0.75 - 1 mm ² (dark grey) 231-672 |  | Insulation stop , 5 pcs/strip 0.08 - 0.2 mm ²  (white) 231-670 0.25 - 0.5 mm ² (light gr.) 231-671 0.75 - 1 mm ² (dark grey) 231-672 |  | Insulation stop , 5 pcs/strip 0.08 - 0.2 mm ²  (white) 231-670 0.25 - 0.5 mm ² (light gr.) 231-671 0.75 - 1 mm ² (dark grey) 231-672 |
|  | Marker strips , self-adhesive 1-12 (40 x) 249-150/210-218 13-24 (40 x) 249-150/210-219 |  | Marker strips , self-adhesive 1-12 (40 x) 249-150/210-218 13-24 (40 x) 249-150/210-219 |  | Tapping screw , B 2.2 x 9.5 209-147 fixing hole Ø 1.8 mm |
| | | | |  | Marker strips , self-adhesive 1-12 (40 x) 249-150/210-218 13-24 (40 x) 249-150/210-219 |

Dimensions (in mm) L₁ = (No. of poles x pin spacing) + 3 mm L₂ = (No. of poles x pin spacing) + 8.8 mm L₃ = (No. of poles x pin spacing) + 14.8 mm

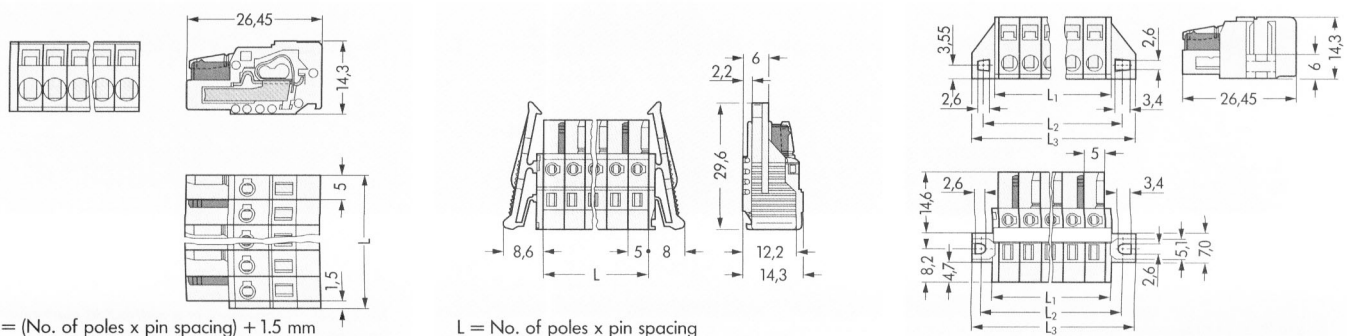

* For further approvals with corresponding ratings see pages 10.3 ff.

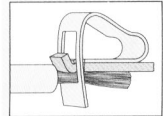

| | | |
|---|---|-------------------------------|
| <p>Pin spacing 5 mm/0.197 in, light grey 0.08 – 2.5 mm² AWG 28 – 12 250 V/4 kV/3 300 V, 15 A 16 A 300 V, 15 A </p> <p> 8 – 9 mm / 0.33 in</p> <p>* </p> | <p>Pin spacing 5 mm/0.197 in, light grey 0.08 – 2.5 mm² AWG 28 – 12 250 V/4 kV/3 300 V, 15 A 16 A 300 V, 15 A </p> <p> 8 – 9 mm / 0.33 in</p> <p>* </p> | <p>Direct printing</p> |
|---|---|-------------------------------|

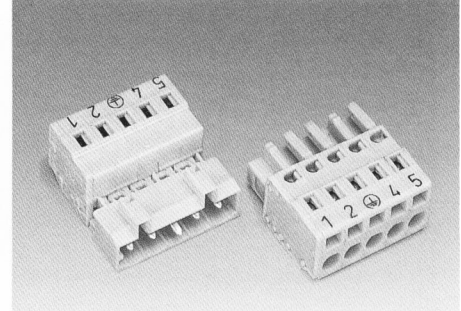
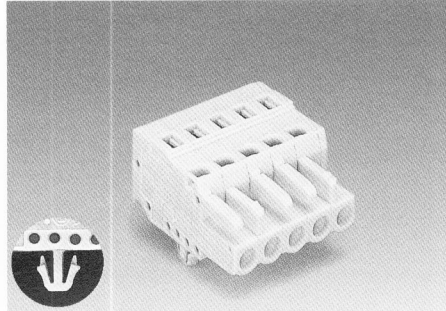
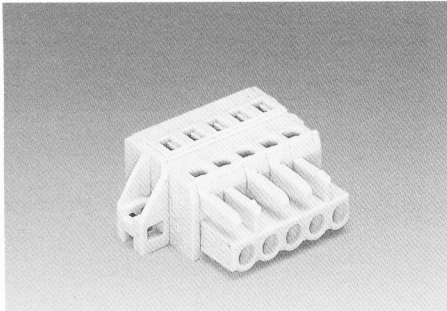

| No. of poles | Item-No. | No. of poles | Item-No. |
|--|-----------------|---|-----------------|
| <p>Female connectors with CAGE CLAMP® and fixing flanges, for panel mounting, 100% protected against mismatching, with coding fingers, with two latches, for screw or similar methods of fixing, light grey</p> | | <p>Female connectors with CAGE CLAMP® and snap-in mounting feet, 100% protected against mismatching, with coding fingers, with two latches, light grey, for plate thickness 0.6 mm–1.2 mm, fixing hole Ø 3.5 mm (or with mounting adapter 209-137 for DIN 35 rail)</p> | |
| 2 (one latch only) | 721-102/031-000 | 2 (one latch only) | 721-102/008-000 |
| 3 | 721-103/031-000 | 3 | 721-103/008-000 |
| 4 | 721-104/031-000 | 4 | 721-104/008-000 |
| 5 | 721-105/031-000 | 5 | 721-105/008-000 |
| 6 | 721-106/031-000 | 6 | 721-106/008-000 |
| : | : | : | : |
| 10 | 721-110/031-000 | 10 | 721-110/008-000 |
| 12 | 721-112/031-000 | 12 | 721-112/008-000 |
| 14 | 721-114/031-000 | 14 | 721-114/008-000 |
| 16 | 721-116/031-000 | 16 | 721-116/008-000 |
| 20 | 721-120/031-000 | 20 | 721-120/008-000 |

3- to 5-pole female connectors with CAGE CLAMP® are available with special printing, suitable for headers and male connectors with preceding ground (earth) contact.

Printing 3-pole: **1-⊕-3**
 4-pole: **1-2-⊕-4**
 5-pole: **1-2-⊕-4-5**

Add. item-No.: **.../...-045**

Ordering example:
 5-pole female connector with locking device, without printing: **721-105/037-000**
 5-pole female connector with locking device, with printing 1-2-⊕-4-5:
721-105/037-045

Other printings – contact factory

| | | |
|---|---|--|
| <p>Test plug, w. cable 500 mm/17.7" 2 mm/0.079 in Ø, red 210-136 2.3 mm/0.091 in Ø, yel. 210-137</p> | <p>Test plug, w. cable 500 mm/17.7" 2 mm/0.079 in Ø, red 210-136 2.3 mm/0.091 in Ø, yel. 210-137</p> | All female connectors with CAGE CLAMP® are also available with printed pole marking. Standard printing: 1-2-3-4-5-... Add. item-No.: .../...-047 |
| <p>Insulation stop, 5 pcs/strip 0.08–0.2 mm² (white) 231-670 0.25–0.5 mm² (light gr.) 231-671 0.75–1 mm² (dark grey) 231-672</p> <p> 0.2 mm² solid/0.14 mm² f-st</p> | <p>Insulation stop, 5 pcs/strip 0.08–0.2 mm² (white) 231-670 0.25–0.5 mm² (light gr.) 231-671 0.75–1 mm² (dark grey) 231-672</p> <p> 0.2 mm² solid/0.14 mm² f-st</p> | |
| <p>Tapping screw, B 2.2 x 9.5 209-147 fixing hole Ø 1.8 mm</p> | <p>Mounting adapter, for DIN 35 rail, grey 209-137 3 or more poles</p> | Ordering example: 3-pole female connector, without printing: 721-103/026-000 3-pole female connector, with printing 1-2-3: 721-103/026-047 |
| <p>Marker strips, self-adhesive 1–12 (40 x) 249-150/210-218 13–24 (40 x) 249-150/210-219</p> | <p>Marker strips, self-adhesive 1–12 (40 x) 249-150/210-218 13–24 (40 x) 249-150/210-219</p> | <p>Other printings – contact factory</p> |

