



## **PTC thermistors for overcurrent protection**

SMDs, EIA sizes 0603 and 1210, 24 V, 42 V, 63 V  
and 230 V

**Series/Type:** B59606, B59607, B59707,  
B59807, B59907, B5962\*

**Date:** November 2011

## Overcurrent protection

SMDs, EIA sizes 0603 and 1210, 24 V, 42 V, 63 V and 230 V

### SMD

#### Applications

- Overcurrent protection
- Short circuit protection

#### Features

- Qualification based on AEC-Q200 rev. D for type A907
- Thermistor chip with lead-free tinned terminations
- Small size
- Short response times
- Suitable for reflow soldering only
- Suitable for automatic placement
- UL approval for selected types (case size 1210)
- RoHS-compatible

#### Delivery mode

- Blister tape (case size 1210) or cardboard tape (case size 0603), 180-mm reel with 8-mm tape, taping to IEC 60286-3

#### Dimensional drawings in mm

##### EIA case size 0603

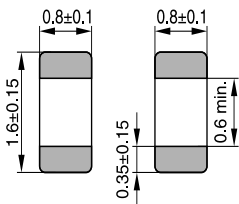

 Termination

TPT0698-5-E

##### Solder pad

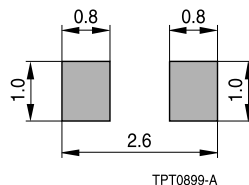

TPT0899-A

##### EIA case size 1210

##### Solder pad

**Overcurrent protection**

**SMDs, EIA sizes 0603 and 1210, 24 V, 42 V, 63 V and 230 V**

**SMD**

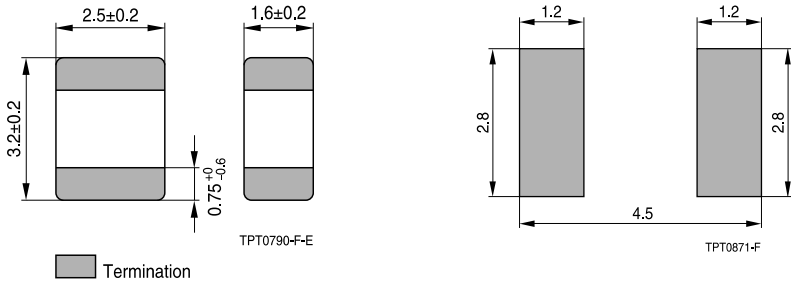

Recommended maximum dimensions (mm)

**Overcurrent protection**
**SMDs, EIA sizes 0603 and 1210, 24 V, 42 V, 63 V and 230 V**
**SMD**
**General technical data**

Switching cycles		N	100	
Tolerance of $R_R$	(except A907)	$\Delta R_R$	$\pm 25$	%
Tolerance of $R_R$	(for A907)	$\Delta R_R$	$\pm 35$	%
Operating temperature range	( $V = 0$ )	$T_{op}$	$-40/+125$	$^{\circ}\text{C}$
Operating temperature range	( $V = V_{max}$ , except A907)	$T_{op}$	$-20/+85$	$^{\circ}\text{C}$
Operating temperature range	( $V = V_{max}$ for A907)	$T_{op}$	$-40/+85$	$^{\circ}\text{C}$

**Electrical specifications and ordering codes**
**Approvals**

Type	$I_R^{(1)}$ mA	$I_S^{(1)}$ mA	$I_{Smax}$ ( $V = V_{max}$ ) A	$R_R$ $\Omega$	$R_{min}$ $\Omega$	EIA case size	Approvals 	Ordering code
<b><math>V_{max} = 30 \text{ V DC or V AC, } V_R = 24 \text{ V DC or V AC}</math></b>								
A606	90	180	0.5	27	17	1210	X	B59606A0110A062
A607	70	130	0.4	55	30	1210	X	B59607A0120A062
<b><math>V_{max} = 60 \text{ V DC or V AC, } V_R = 42 \text{ V DC or V AC}</math></b>								
A622	22	47	0.22	220	150	0603	–	B59622A0090A062
<b><math>V_{max} = 80 \text{ V DC or V AC, } V_R = 63 \text{ V DC or V AC}</math></b>								
A623	15	33	0.15	470	300	0603	–	B59623A0090A062
A707	50	90	0.3	125	75	1210	X	B59707A0120A062
<b><math>V_{max} = 265 \text{ V DC or V AC, } V_R = 230 \text{ V DC or V AC}</math></b>								
A807	15	40	0.2	400	200	1210	X	B59807A0090A062
<b><math>V_{max} = 400 \text{ V DC or V AC, } V_R = 230 \text{ V DC or V AC}</math></b>								
A907	12	22	0.15	1500	640	1210	X	B59907A0120A062

1) Measured on component soldered to standardized PCB

**Overcurrent protection**
**SMDs, EIA sizes 0603 and 1210, 24 V, 42 V, 63 V and 230 V**
**SMD**
**Reliability data**

Test	Standard	Test conditions	$ \Delta R_{25}/R_{25} $
Electrical endurance, cycling	IEC 60738-1	Room temperature, $I_{Smax}; V_{max}$ Number of cycles: 100	< 25%
Electrical endurance, constant	IEC 60738-1	Storage at $V_{max}/T_{op,max}$ ( $V_{max}$ ) Test duration: 1000 h	< 25%
Damp heat	IEC 60738-1	Temperature of air: 40 °C Relative humidity of air: 93% Duration: 56 days Test according to IEC 60068-2-78	< 10%
Rapid change of temperature	IEC 60738-1	$T_1 = T_{op,min}$ (0 V), $T_2 = T_{op,max}$ (0 V) Number of cycles: 5 Test duration: 30 min Test according to IEC 60068-2-14, test Na	< 10%
Vibration	IEC 60738-1	Frequency range: 10 to 55 Hz Displacement amplitude: 0.75 mm Test duration: 3 × 2 h Test according to IEC 60068-2-6, test Fc	< 5%
Shock	IEC 60738-1	Acceleration: 390 m/s <sup>2</sup> Pulse duration: 6 ms; 6 × 4000 pulses	< 5%
Climatic sequence	IEC 60738-1	Dry heat: $T = T_{op,max}$ (0 V) Test duration: 16 h Damp heat first cycle Cold: $T = T_{op,min}$ (0 V) Test duration: 2 h Damp heat 5 cycles Tests performed according to IEC 60068-2-30	< 10%
Bending test	IEC 60738-1	Components reflow-soldered to test board Maximum bending: 2 mm Test according to IEC 60068-2-21, test Ue	< 10%
Adhesive strength on PCB		A shear force of 5 N is applied perpendicular to the longitudinal axis of the component which is soldered on PCB.	No visible damage

## Overcurrent protection

SMDs, EIA sizes 0603 and 1210, 24 V, 42 V, 63 V and 230 V

### SMD

#### Characteristics (typical) for A606, A607 and A707

PTC resistance  $R_{PTC}$  versus  
PTC temperature  $T_{PTC}$   
(measured at low signal voltage)

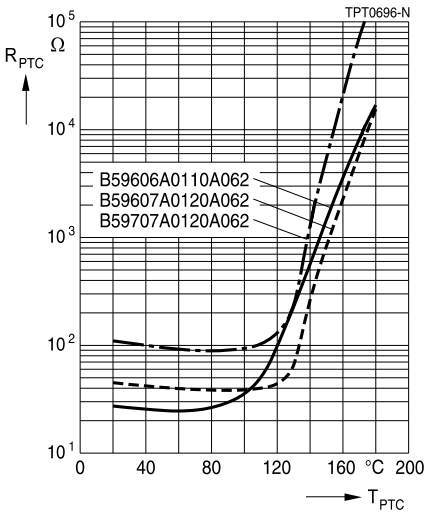

Switching time  $t_S$  versus switching current  $I_S$   
(measured at 25  $^{\circ}\text{C}$  in still air)

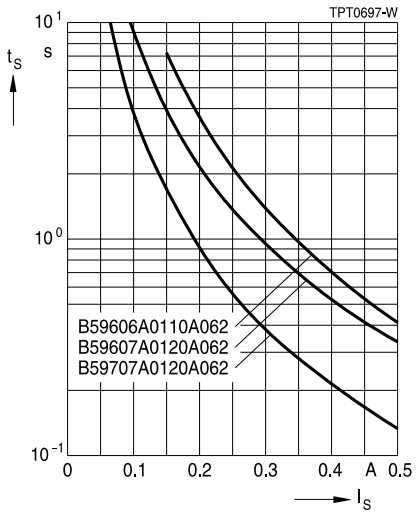

Rated current  $I_R$  versus ambient temperature  $T_A$   
(measured in still air)

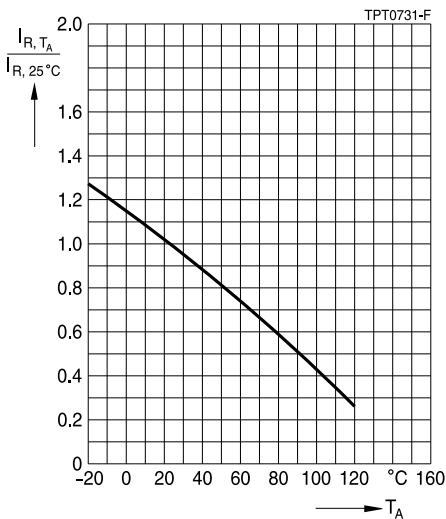

## Overcurrent protection

SMDs, EIA sizes 0603 and 1210, 24 V, 42 V, 63 V and 230 V

### SMD

#### Characteristics (typical) for A807

PTC resistance  $R_{PTC}$  versus

PTC temperature  $T_{PTC}$

(measured at low signal voltage)

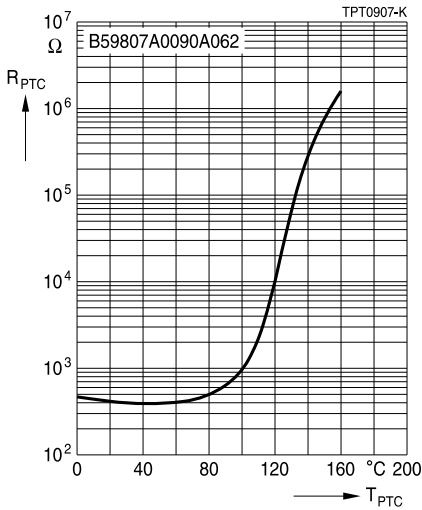

Switching time  $t_S$  versus switching current  $I_S$

(measured at 25  $^{\circ}\text{C}$  in still air)

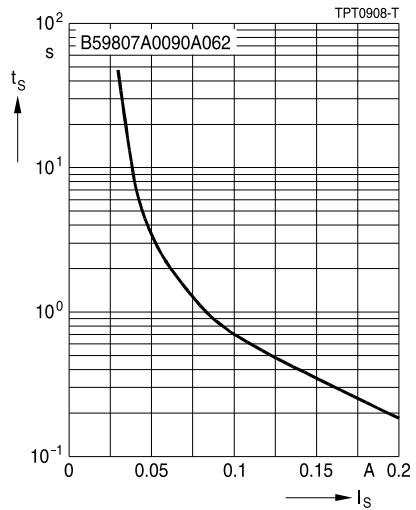

Rated current  $I_R$  versus ambient temperature  $T_A$

(measured in still air)

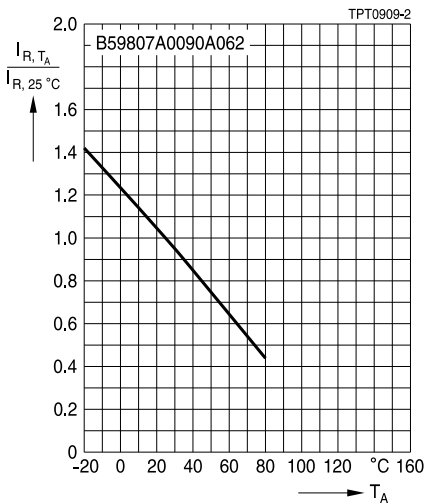

## Overcurrent protection

SMDs, EIA sizes 0603 and 1210, 24 V, 42 V, 63 V and 230 V

### SMD

#### Characteristics (typical) for A907

PTC resistance  $R_{PTC}$  versus

PTC temperature  $T_{PTC}$

(measured at low signal voltage)

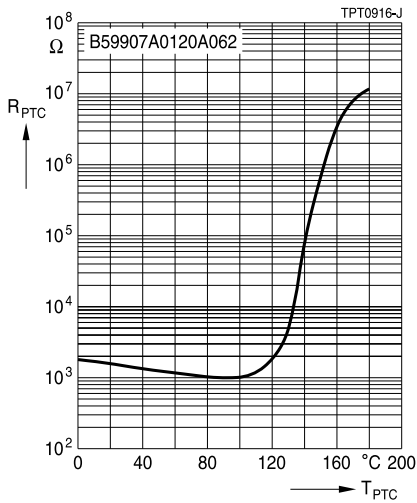

Switching time  $t_S$  versus switching current  $I_S$

(measured at 25 °C in still air)

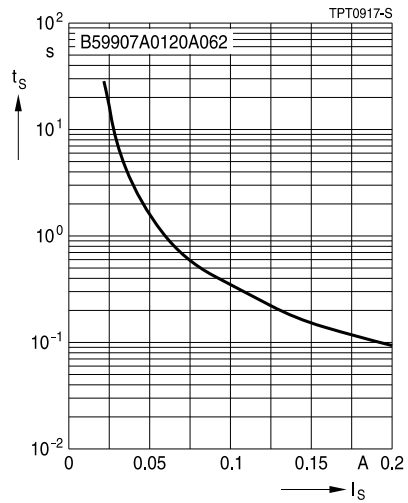

Rated current  $I_R$  versus ambient temperature  $T_A$

(measured in still air)

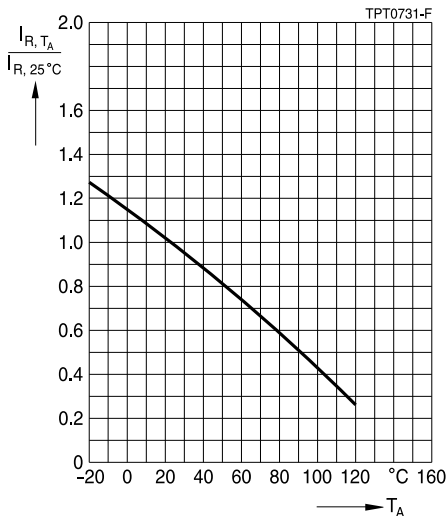



## Overcurrent protection

SMDs, EIA sizes 0603 and 1210, 24 V, 42 V, 63 V and 230 V

### SMD

#### Characteristics (typical) for A622 and A623

PTC resistance  $R_{PTC}$  versus

PTC temperature  $T_{PTC}$

(measured at low signal voltage)

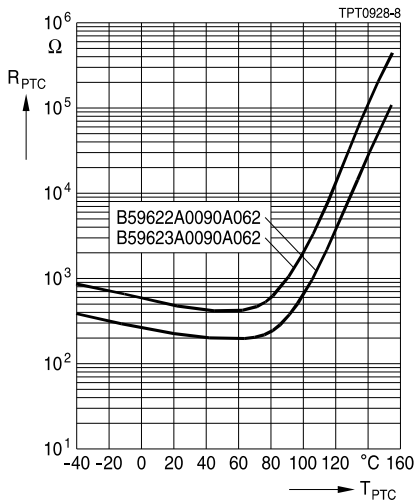

Switching time  $t_S$  versus switching current  $I_S$

(measured at 25  $^{\circ}C$  in still air)

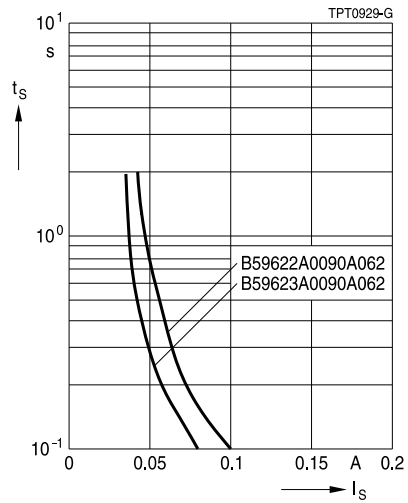

Rated current  $I_R$  versus ambient temperature  $T_A$

(measured in still air)

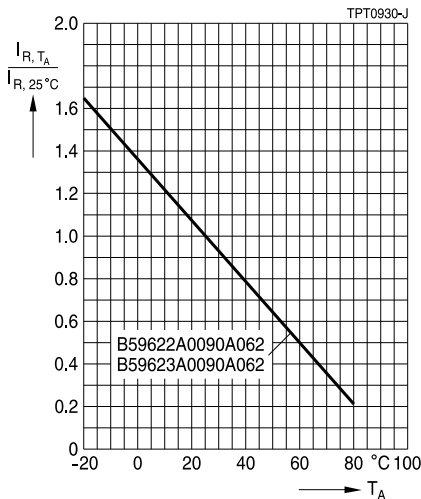

#### Taping and packing

**Overcurrent protection**
**SMDs, EIA sizes 0603 and 1210, 24 V, 42 V, 63 V and 230 V**
**SMD**

Many of the components presented in this data book are suitable for processing on automatic insertion or placement machines. These thermistors can be supplied on tape for easy handling by automatic systems. The individual modes of taping and packing will be described in the following.

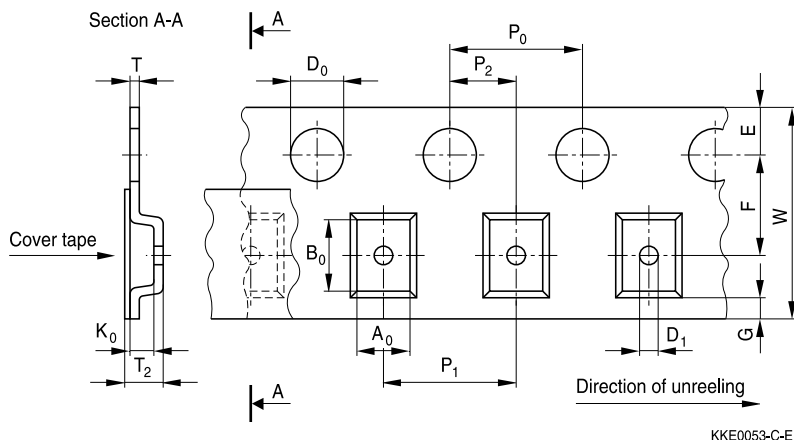
**1 Taping of SMD thermistors**
**1.1 Blister tape (to IEC 60286-3)**

**Figure 1**

Dimension (mm)	8-mm tape	16-mm tape	Tolerance (mm)	24-mm tape	Tolerance (mm)
$D_0$	1.50	1.50	+ 0.10/–0 min.	1.50	+ 0.10
$D_1$	1.00	1.50		1.50	+ 0.10
$P_0$	4.00	4.00	$\pm 0.10$ <sup>1)</sup>	4.00	$\pm 0.10$
$P_2$	2.00	2.00	$\pm 0.05$	2.00	$\pm 0.10$
$P_1$	4.00	12.00	$\pm 0.10$	16.00	$\pm 0.10$
$W$	8.00	16.00	$\pm 0.30$	24.00	+ 0.30/–0.1
$E$	1.75	1.75	$\pm 0.10$	1.75	$\pm 0.10$
$F$	3.50	7.50	$\pm 0.05$	11.50	$\pm 0.10$
$G$	0.75	0.75	min.	0.75	min.

$A_0 \times B_0$ ,  $K_0$ ,  $T_2$ : The rated dimensions of the component compartment have been derived from the relevant component specification and are chosen such that the components cannot change their orientation within the tape.

1)  $\leq 0.2$  mm over 10 sprocket holes

## Overcurrent protection

SMDs, EIA sizes 0603 and 1210, 24 V, 42 V, 63 V and 230 V

### SMD

#### Part orientation in tape pocket for blister tape

For chip thermistors case sizes 0805 and 1210

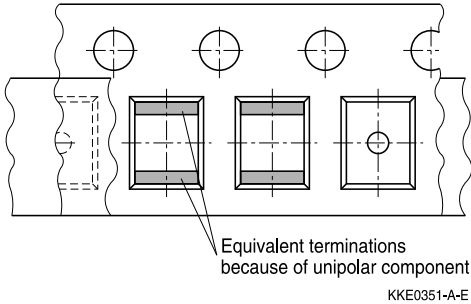
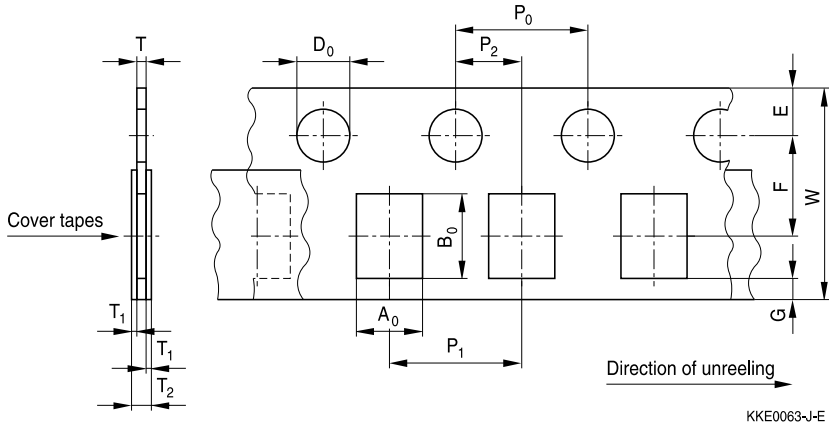

Figure 2

#### Additional taping information

For chip thermistors case sizes 0805 and 1210

Reel material	Polystyrol (PS)
Tape material	Polystyrol (PS) or Polycarbonat (PC) or PVC
Tape break force	min. 10 N
Top cover tape strength	min. 10 N
Top cover tape peel force	0.2 ... 0.6 N for 8-mm tape and 0.2 ... 0.8 N for 12-mm tape at a peel speed of 300 mm/min
Tape peel angle	Angle between top cover tape and the direction of feed during peel off: 165° ... 180°
Cavity play	Each part rests in the cavity so that the angle between the part and cavity center line is no more than 20°

**Overcurrent protection**
**SMDs, EIA sizes 0603 and 1210, 24 V, 42 V, 63 V and 230 V**
**SMD**
**1.2 Cardboard tape (to IEC 60286-3)**

**Figure 3**

Dimensions (mm)	8-mm tape		Tolerance (mm)
	Case size		
	0402	0603	
A <sub>0</sub>	0.6	0.95	±0.2
B <sub>0</sub>	1.15	1.8	±0.2
T	0.6	0.95	±0.05
T <sub>2</sub>	0.75	1.1	max.
D <sub>0</sub>	1.5		+0.1/-0
P <sub>0</sub>	4.0	4.0	±0.1 <sup>2)</sup>
P <sub>2</sub>	2.0	2.0	±0.05
P <sub>1</sub>	2.0	4.0	±0.1
W	8.0		±0.3
E	1.75		±0.1
F	3.5		±0.05
G	0.75		min.

2) ≤0.2 mm over 10 sprocket holes.

**Overcurrent protection**

**SMDs, EIA sizes 0603 and 1210, 24 V, 42 V, 63 V and 230 V**

**SMD**

**Part orientation in tape pocket for cardboard tape**

For chip thermistors case sizes 0402 and 0603

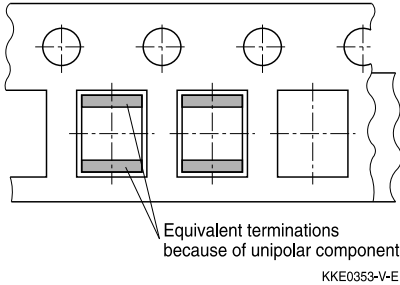

Figure 4

**Additional taping information**

Reel material	Polystyrol (PS)
Tape material	Cardboard
Tape break force	min. 10 N
Top cover tape strength	min. 10 N
Top cover tape peel force	0.1 ... 0.65 N at a peel speed of 300 mm/min
Tape peel angle	Angle between top cover tape and the direction of feed during peel off: 165° ... 180°
Cavity play	Each part rests in the cavity so that the angle between the part and cavity center line is no more than 20°

## Overcurrent protection

SMDs, EIA sizes 0603 and 1210, 24 V, 42 V, 63 V and 230 V

### SMD

#### 1.3 Reel dimensions

##### 180-mm reel with 8-mm tape

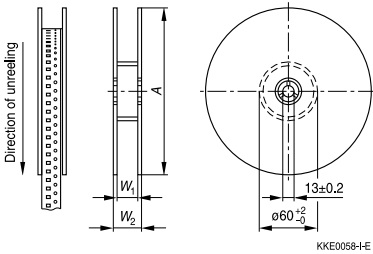

Figure 5

Dimension	180-mm reel
A	180 $-2/+0$
W <sub>1</sub>	8.4 $+1.5/-0$
W <sub>2</sub>	14.4 max.

##### 330-mm reel with 16-mm tape

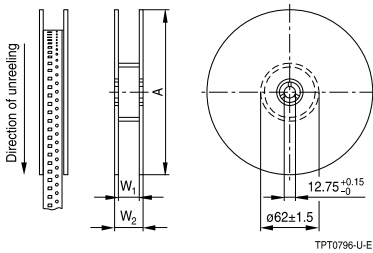

Figure 6

Dimension	330-mm reel
A	330 $-2/+0$
W <sub>1</sub>	16.4 $+2.0/-0$
W <sub>2</sub>	22.4 max.

##### 330-mm reel with 24-mm tape

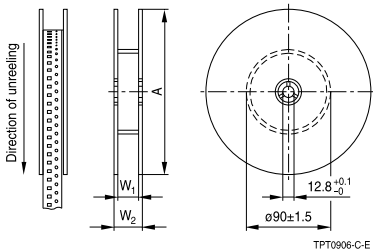

Figure 7

Dimension	330-mm reel
A	330 $-2/+0$
W <sub>1</sub>	24.4 min.
W <sub>2</sub>	30.4 max.

##### 380-mm reel with 24-mm tape

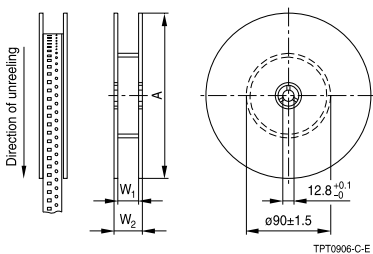

Figure 8

Dimension	380-mm reel
A	380 $-2/+0$
W <sub>1</sub>	24.4 min.
W <sub>2</sub>	30.4 max.

## Overcurrent protection

SMDs, EIA sizes 0603 and 1210, 24 V, 42 V, 63 V and 230 V

### SMD

## Mounting instructions

### 1 Soldering

#### 1.1 Leaded PTC thermistors

Leaded PTC thermistors follow the solderability requirements of IEC 60068-2-20.

During soldering, care must be taken that the thermistors are not damaged by excessive heat. The following maximum temperatures, maximum time spans and minimum distances have to be observed:

	Solder containing lead (SnPb 60/40)	Lead-free solder (Sn96.5Ag3Cu0.5)
Solderability	Solder bath temperature 230 °C Soldering time 3 s	Solder bath temperature 245 °C Soldering time 3 s
Resistance to soldering heat	Soldering iron temperature 350 °C Soldering time 3 s	Solder bath temperature 260 °C Soldering time 10 s

Distance to thermistor has to be  $\geq 6$  mm. Under more severe soldering conditions the resistance may change. Soldering conditions for wave soldering are given in chapter 1.4.1.

#### 1.2 Leadless PTC thermistors

In case of PTC thermistors without leads, soldering is restricted to devices which are provided with a solderable metallization. The temperature shock caused by the application of hot solder may produce fine cracks in the ceramic, resulting in changes in resistance.

In addition, soldering methods should be employed which permit short soldering times.

Soldering conditions for wave soldering are given in chapter 1.4.1.

#### 1.3 SMD PTC thermistors

The notes on soldering leadless thermistors also apply to the SMD versions (refer to IEC 60068-2-58). Soldering conditions for wave soldering are given in chapter 1.4.1., for reflow soldering in chapter 1.4.2.

##### 1.3.1 Chrome/nickel/tin terminations

(Sizes 0402, 0603, 0805, 1210)

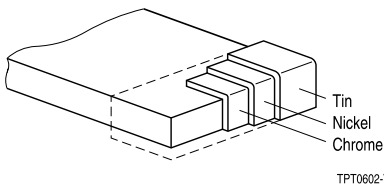

As shown in the figure above, the terminations consists of three metallic layers. A primary chrome layer provides for good electrical contact. "Leaching" is prevented by a nickel barrier layer. The outer tin coating prevents corrosion of the nickel and ensures good component solderability.

**Overcurrent protection**
**SMDs, EIA sizes 0603 and 1210, 24 V, 42 V, 63 V and 230 V**
**SMD**
**1.3.2 Test methods for wetting and resistance to soldering heat**
**a) Solder bath method according to IEC 60068-2-58**

Applicable for SMD components with wire or tag terminations. In case the SMD-component does not have a completely closed housing, only the wires or tags may be immersed into the solder bath.

	Lead-free solder (Sn96.5Ag3Cu0.5)	Solder containing lead (SnPb 60/40)
Wetting test	Bath temperature 250 °C Soldering time 3 s	Bath temperature 215 °C Soldering time 3 s
Resistance to soldering heat	Bath temperature 260 °C Soldering time 10 s	Bath temperature 260 °C Soldering time 10 s

**b) Solder reflow method according to IEC 60068-2-58**

Applicable for chip-style SMD components. Reflow temperature profile is stated in IEC 60068-2-58, 8.1.2.1 for wetting test and 8.1.2.2 for resistance to soldering heat test.

	Lead-free solder (Sn96.5Ag3Cu0.5)	Solder containing lead (SnPb 60/40)
Wetting test	Peak temperature 225 ... 235 °C Duration maximum 20 s	Peak temperature 215 °C Duration maximum 10 s
Resistance to soldering heat	Peak temperature 245 ... 255 °C Duration maximum 20 s	Peak temperature 235 °C Duration maximum 30 s



## Overcurrent protection

### SMDs, EIA sizes 0603 and 1210, 24 V, 42 V, 63 V and 230 V

#### SMD

### 1.3.3 Placement and orientation of SMDs on PCB

#### a) Component placement

##### Incorrect

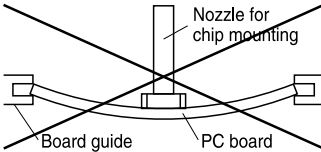

##### Correct

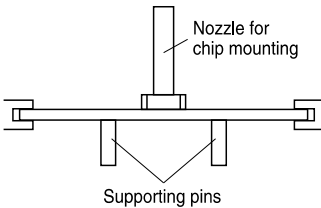

KKE0267-U-E

It is recommended that the PC board should be held by means of some adequate supporting pins such as shown left to prevent the SMDs from being damaged or cracked.

#### b) Cracks

SMDs located near an easily warped area

SMD breakage probability due to stress at a breakaway

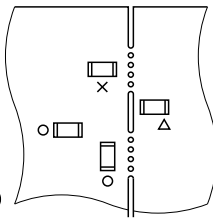
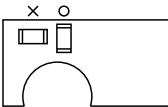

O = correct  
X = incorrect  
△ = incorrect  
(under certain conditions)

KKE0268-3-E

When placing a component near an area which is apt to bend or a grid groove on the PC board, it is advisable to have both electrodes subjected to uniform stress, or to position the component's electrodes at right angles to the grid groove or bending line.

#### c) Component orientation

Locate chip horizontal to the direction in which stress acts

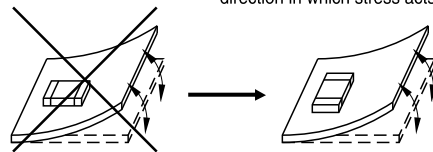

Incorrect orientation

Correct orientation

KKE0269-B-E

Choose a mounting position that minimizes the stress imposed on the chip during flexing or bending of the board.

## Overcurrent protection

SMDs, EIA sizes 0603 and 1210, 24 V, 42 V, 63 V and 230 V

### SMD

#### 1.4 Soldering profiles

##### 1.4.1 Wave soldering

Recommended temperature profile for wave soldering following IEC 61760-1. Applicable for leaded PTCs and selected SMD PTCs (case sizes 3225 and 4032 as well as superior series for case sizes 0402, 0603 and 0805 limit temperature sensors).

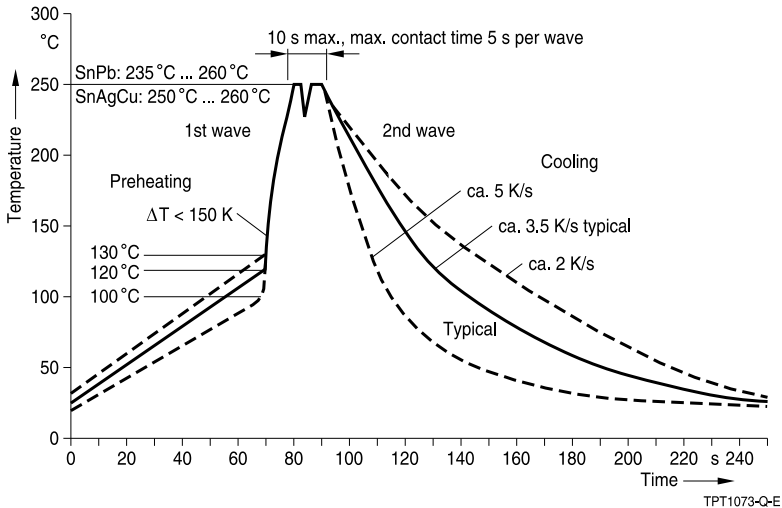

## Overcurrent protection

SMDs, EIA sizes 0603 and 1210, 24 V, 42 V, 63 V and 230 V

### SMD

#### 1.4.2 Reflow soldering

Recommended temperature characteristic for reflow soldering following JEDEC J-STD-020D

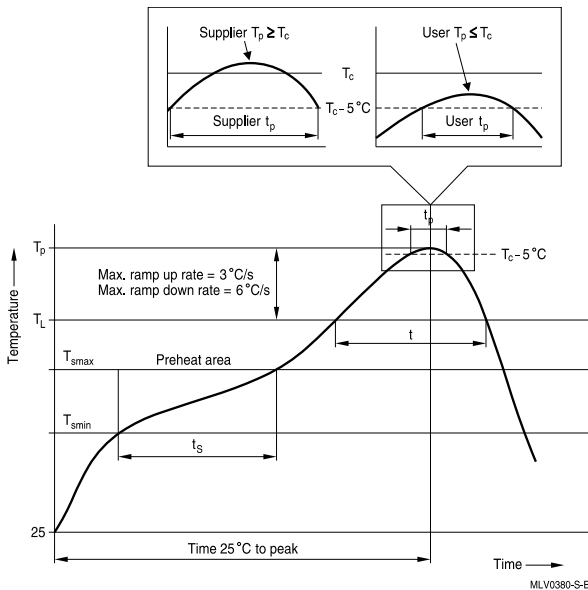

Profile feature		Sn-Pb eutectic assembly	Pb-free assembly
Preheat and soak			
- Temperature min	$T_{smin}$	100 °C	150 °C
- Temperature max	$T_{smax}$	150 °C	200 °C
- Time	$t_{smin}$ to $t_{smax}$	60 ... 120 s	60 ... 180 s
Average ramp-up rate	$T_{smax}$ to $T_p$	3 °C/ s max.	3 °C/ s max.
Liquidous temperature	$T_L$	183 °C	217 °C
Time at liquidous	$t_L$	60 ... 150 s	60 ... 150 s
Peak package body temperature	$T_p^{(1)}$	220 °C ... 235 °C <sup>(2)</sup>	245 °C ... 260 °C <sup>(2)</sup>
Time ( $t_p$ ) <sup>(3)</sup> within 5 °C of specified classification temperature ( $T_c$ )		20 s <sup>(3)</sup>	30 s <sup>(3)</sup>
Average ramp-down rate	$T_p$ to $T_{smax}$	6 °C/ s max.	6 °C/ s max.
Time 25 °C to peak temperature		maximum 6 min	maximum 8 min

1) Tolerance for peak profile temperature ( $T_p$ ) is defined as a supplier minimum and a user maximum.

2) Depending on package thickness. For details please refer to JEDEC J-STD-020D.

3) Tolerance for time at peak profile temperature ( $t_p$ ) is defined as a supplier minimum and a user maximum.

**Note:** All temperatures refer to topside of the package, measured on the package body surface.  
Number of reflow cycles: 3

**Overcurrent protection**

**SMDs, EIA sizes 0603 and 1210, 24 V, 42 V, 63 V and 230 V**

**SMD**

**1.4.3 Solder joint profiles for PTC theristors with chrome/nickel/tin terminations**

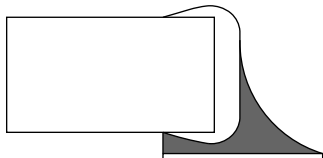

Good solder joint

TPT0808-M-E

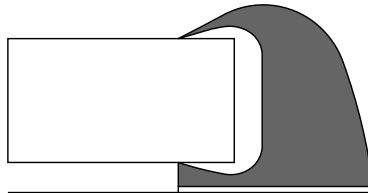

Too much solder  
Pad geometry too large

KKE0071-A-E

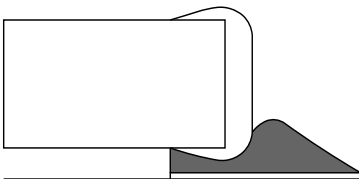

Poor wetting

KKE00724-E

**2 Storage of PTC thermistors**

PTC thermistors should be soldered after shipment from EPCOS within the time specified:  
Use thermistor within the following period after delivery:

Through-hole devices (housed and leaded PTCs)	24 months
Motor protection sensors, glass-encapsulated sensors and probe assemblies	24 months
Telecom pair and quattro protectors (TPP, TQP)	24 months
Leadless PTC thermistors for pressure contacting	12 months
Leadless PTC thermistors for soldering	6 months
SMDs in EIA sizes 3225 and 4032, and for PTCs with metal tags	24 months
SMDs in EIA sizes 0402, 0603, 0805 and 1210	12 months

The parts are to be left in the original packing.

Storage temperature: -25 ... + 45 °C

Relative humidity: ≤ 75% annual average, ≤ 95% on 30 days in a year

The solderability of the external electrodes may be deteriorated if SMDs are stored where they are exposed to high humidity, dust or harmful gas (hydrogen chloride, sulfuric acid gas or hydrogen sulfide).

## Overcurrent protection

SMDs, EIA sizes 0603 and 1210, 24 V, 42 V, 63 V and 230 V

### SMD

Do not store SMDs where they are exposed to heat or direct sunlight. Otherwise, the packing material may be deformed or SMDs may stick together, causing problems during mounting.

After opening the factory seals, such as polyvinyl-sealed packages, it is recommended to use the components as soon as possible.

### 3 Conductive adhesion

An alternative to soldering is the gluing of thermistors with conductive adhesives. The benefit of this method is that it involves no thermal stress. The adhesives used must be chemically inert and suitable for the temperatures arising at the surface of the thermistor.

### 4 Clamp contacting

Pressure contacting by springs is required for applications involving frequent switching and high turn-on powers. Soldering is not allowed for such applications in order to avoid operational failure in the long term. PTC thermistors for heating and motor starting have metallized surfaces for clamp contacting.

### 5 Robustness of terminations

The leads meet the requirements of IEC 60068-2-21. They may not be bent closer than 4 mm from the solder joint on the thermistor body or from the point at which they leave the feedthroughs. During bending, any mechanical stress at the outlet of the leads must be removed. The bending radius should be at least 0.75 mm.

Tensile strength: Test Ua1:

Leads

$\varnothing \leq 0.5 \text{ mm} = 5 \text{ N}$

$\varnothing > 0.5 \text{ mm} = 10 \text{ N}$

Bending strength: Test Ub:

Two 90°-bends in opposite directions at a weight of 0.25 kg.

Torsional strength: Test Uc: severity 2

The lead is bent by 90° at a distance of 6 to 6.5 mm from the thermistor body.

The bending radius of the leads should be approx. 0.75 mm. Two torsions of 180° each (severity 2).

## Overcurrent protection

SMDs, EIA sizes 0603 and 1210, 24 V, 42 V, 63 V and 230 V

### SMD

When subjecting leads to mechanical stress, the following should be observed:

#### *Tensile stress on leads*

During mounting and operation tensile forces on the leads are to be avoided.

#### *Bending of leads*

Bending of the leads directly on the thermistor body is not permissible.

A lead may be bent at a minimum distance of twice the wire's diameter +2 mm from the solder joint on the thermistor body. During bending the wire must be mechanically relieved at its outlet. The bending radius should be at least 0.75 mm.

#### *Twisting of leads*

The twisting (torsion) by 180° of a lead bent by 90° is permissible at 6 mm from the bottom of the thermistor body.

## 6 Sealing and potting

When thermistors are sealed or potted, there must be no mechanical stress through differing thermal expansion in the curing process and during later operation. In the curing process the upper category temperature of the thermistor must not be exceeded. It is also necessary to ensure that the potting compound is chemically inert.

Sealing and potting compounds may degenerate the titanate ceramic of PTC thermistors and lead to the formation of low-ohmic conduction bridges. In conjunction with a change in dissipation conditions due to the potting compound, local overheating may finally damage the thermistor.

Therefore sealing and potting should be avoided whenever possible.

## 7 Cleaning

You may use common cleaners based on organic solvents (eg dowanol or alcohol) to clean ceramic and solder joints.

For sufficient cleaning flux must be completely removed.

Solvents may cause plastic encapsulations to swell or detach. So be sure to check the suitability of a solvent before using it.

Caution is required with ultrasonic processes. If the sound power is too high, for example, it can degrade the adhesive strength of the terminal metallization or cause the encapsulation to detach.

After cleaning drying is promptly necessary.

## Overcurrent protection

SMDs, EIA sizes 0603 and 1210, 24 V, 42 V, 63 V and 230 V

### SMD

## Cautions and warnings

### General

- EPCOS thermistors are designed for specific applications and should not be used for purposes not identified in our specifications, application notes and data books unless otherwise agreed with EPCOS during the design-in-phase.
- Ensure suitability of thermistor through reliability testing during the design-in phase. The thermistors should be evaluated taking into consideration worst-case conditions.

### Storage

- Store thermistors only in original packaging. Do not open the package before storage.
- Storage conditions in original packaging: storage temperature  $-25\text{ °C} \dots +45\text{ °C}$ , relative humidity  $\leq 75\%$  annual mean, maximum 95%, dew precipitation is inadmissible.
- Avoid contamination of thermistors surface during storage, handling and processing.
- Avoid storage of thermistor in harmful environment with effect on function on long-term operation (examples given under operation precautions).
- Use thermistor within the following period after delivery:
  - Through-hole devices (housed and leaded PTCs): 24 months
  - Motor protection sensors, glass-encapsulated sensors and probe assemblies: 24 months
  - Telecom pair and quattro protectors (TPP, TQP): 24 months
  - Leadless PTC thermistors for pressure contacting: 12 months
  - Leadless PTC thermistors for soldering: 6 months
  - SMDs in EIA sizes 3225 and 4032, and for PTCs with metal tags: 24 months
  - SMDs in EIA sizes 0402, 0603, 0805 and 1210: 12 months

### Handling

- PTCs must not be dropped. Chip-offs must not be caused during handling of PTCs.
- Components must not be touched with bare hands. Gloves are recommended.
- Avoid contamination of thermistor surface during handling.

### Soldering (where applicable)

- Use rosin-type flux or non-activated flux.
- Insufficient preheating may cause ceramic cracks.
- Rapid cooling by dipping in solvent is not recommended.
- Complete removal of flux is recommended.
- Standard PTC heaters are not suitable for soldering.

## Overcurrent protection

SMDs, EIA sizes 0603 and 1210, 24 V, 42 V, 63 V and 230 V

### SMD

#### Mounting

- Electrode must not be scratched before/during/after the mounting process.
- Contacts and housing used for assembly with thermistor have to be clean before mounting. Especially grease or oil must be removed.
- When PTC thermistors are encapsulated with sealing material, the precautions given in chapter "Mounting instructions", "Sealing and potting" must be observed.
- When the thermistor is mounted, there must not be any foreign body between the electrode of the thermistor and the clamping contact.
- The minimum force of the clamping contacts pressing against the PTC must be 10 N.
- During operation, the thermistor's surface temperature can be very high. Ensure that adjacent components are placed at a sufficient distance from the thermistor to allow for proper cooling at the thermistors.
- Ensure that adjacent materials are designed for operation at temperatures comparable to the surface temperature of thermistor. Be sure that surrounding parts and materials can withstand this temperature.
- Avoid contamination of thermistor surface during processing.

#### Operation

- Use thermistors only within the specified temperature operating range.
- Use thermistors only within the specified voltage and current ranges.
- Environmental conditions must not harm the thermistors. Use thermistors only in normal atmospheric conditions. Avoid use in deoxidizing gases (chlorine gas, hydrogen sulfide gas, ammonia gas, sulfuric acid gas etc), corrosive agents, humid or salty conditions. Contact with any liquids and solvents should be prevented.
- Be sure to provide an appropriate fail-safe function to prevent secondary product damage caused by abnormal function (e.g. use VDR for limitation of overvoltage condition).



## Overcurrent protection

SMDs, EIA sizes 0603 and 1210, 24 V, 42 V, 63 V and 230 V

### SMD

#### Symbols and terms

A	Area
$C_{th}$	Heat capacity
f	Frequency
I	Current
$I_{max}$	Maximum current
$I_R$	Rated current
$I_{PTC}$	PTC current
$I_r$	Residual current
$I_{r,oil}$	Residual current in oil (for level sensors)
$I_{r,air}$	Residual current in air (for level sensors)
$I_{RMS}$	Root-mean-square value of current
$I_S$	Switching current
$I_{Smax}$	Maximum switching current
LCT	Lower category temperature
N	Number (integer)
$N_c$	Operating cycles at $V_{max}$ , charging of capacitor
$N_f$	Switching cycles at $V_{max}$ , failure mode
P	Power
$P_{25}$	Maximum power at 25 °C
$P_{el}$	Electrical power
$P_{diss}$	Dissipation power
$R_G$	Generator internal resistance
$R_{min}$	Minimum resistance
$R_R$	Rated resistance
$\Delta R_R$	Tolerance of $R_R$
$R_P$	Parallel resistance
$R_{PTC}$	PTC resistance
$R_{ref}$	Reference resistance
$R_S$	Series resistance
$R_{25}$	Resistance at 25 °C
$R_{25,match}$	Resistance matching per reel/ packing unit at 25 °C
$\Delta R_{25}$	Tolerance of $R_{25}$
T	Temperature
t	Time
$T_A$	Ambient temperature
$t_a$	Thermal threshold time
$T_C$	Ferroelectric Curie temperature

## Overcurrent protection

SMDs, EIA sizes 0603 and 1210, 24 V, 42 V, 63 V and 230 V

### SMD

$t_E$	Settling time (for level sensors)
$T_R$	Rated temperature
$T_{sense}$	Sensing temperature
$T_{op}$	Operating temperature
$T_{PTC}$	PTC temperature
$t_R$	Response time
$T_{ref}$	Reference temperature
$T_{Rmin}$	Temperature at minimum resistance
$t_S$	Switching time
$T_{surf}$	Surface temperature
UCT	Upper category temperature
$V$ or $V_{el}$	Voltage (with subscript only for distinction from volume)
$V_{RMS}$	Root-mean-square value of voltage
$V_{BD}$	Breakdown voltage
$V_{ins}$	Insulation test voltage
$V_{link,max}$	Maximum link voltage
$V_{max}$	Maximum operating voltage
$V_{max,dyn}$	Maximum dynamic (short-time) operating voltage
$V_{meas}$	Measuring voltage
$V_{meas,max}$	Maximum measuring voltage
$V_R$	Rated voltage
$V_{PTC}$	Voltage drop across a PTC thermistor
$\alpha$	Temperature coefficient
$\Delta$	Tolerance, change
$\delta_{th}$	Dissipation factor
$\tau_{th}$	Thermal cooling time constant
$\lambda$	Failure rate
$e$	Lead spacing (in mm)

### Abbreviations / Notes

SMD Surface-mount devices

\* To be replaced by a number in ordering codes, type designations etc.

+ To be replaced by a letter

All dimensions are given in mm.

The commas used in numerical values denote decimal points.

## Important notes

The following applies to all products named in this publication:

1. Some parts of this publication contain **statements about the suitability of our products for certain areas of application**. These statements are based on our knowledge of typical requirements that are often placed on our products in the areas of application concerned. We nevertheless expressly point out **that such statements cannot be regarded as binding statements about the suitability of our products for a particular customer application**. As a rule, EPCOS is either unfamiliar with individual customer applications or less familiar with them than the customers themselves. For these reasons, it is always ultimately incumbent on the customer to check and decide whether an EPCOS product with the properties described in the product specification is suitable for use in a particular customer application.
2. We also point out that **in individual cases, a malfunction of electronic components or failure before the end of their usual service life cannot be completely ruled out in the current state of the art, even if they are operated as specified**. In customer applications requiring a very high level of operational safety and especially in customer applications in which the malfunction or failure of an electronic component could endanger human life or health (e.g. in accident prevention or lifesaving systems), it must therefore be ensured by means of suitable design of the customer application or other action taken by the customer (e.g. installation of protective circuitry or redundancy) that no injury or damage is sustained by third parties in the event of malfunction or failure of an electronic component.
3. **The warnings, cautions and product-specific notes must be observed.**
4. In order to satisfy certain technical requirements, **some of the products described in this publication may contain substances subject to restrictions in certain jurisdictions (e.g. because they are classed as hazardous)**. Useful information on this will be found in our Material Data Sheets on the Internet ([www.epcos.com/material](http://www.epcos.com/material)). Should you have any more detailed questions, please contact our sales offices.
5. We constantly strive to improve our products. Consequently, **the products described in this publication may change from time to time**. The same is true of the corresponding product specifications. Please check therefore to what extent product descriptions and specifications contained in this publication are still applicable before or when you place an order. We also **reserve the right to discontinue production and delivery of products**. Consequently, we cannot guarantee that all products named in this publication will always be available. The aforementioned does not apply in the case of individual agreements deviating from the foregoing for customer-specific products.
6. Unless otherwise agreed in individual contracts, **all orders are subject to the current version of the "General Terms of Delivery for Products and Services in the Electrical Industry" published by the German Electrical and Electronics Industry Association (ZVEI)**.
7. The trade names EPCOS, BAOKE, Alu-X, CeraDiode, CSMP, CSSP, CTVS, DeltaCap, DigiSiMic, DSSP, FormFit, MiniBlue, MiniCell, MKK, MKD, MLSC, MotorCap, PCC, PhaseCap, PhaseCube, PhaseMod, PhiCap, SIFERRIT, SIFI, SIKOREL, SilverCap, SIMDAD, SiMic, SIMID, SineFormer, SIOV, SIP5D, SIP5K, ThermoFuse, WindCap are **trade-marks registered or pending** in Europe and in other countries. Further information will be found on the Internet at [www.epcos.com/trademarks](http://www.epcos.com/trademarks).