



M.S.KENNEDY CORP.

1.5A LOW NOISE, FIXED OUTPUT LDO REGULATOR

5140 SERIES

4707 Dey Road Liverpool, N.Y. 13088

(315) 701-6751

FEATURES:

- Fast Transient Response
- Low Dropout Voltage: 340mV @ 1.5A
- Low Noise: 40uVrms (10Hz to 100KHz)
- Fixed Output Voltages: 1.5V, 1.7V, 1.8V, 1.9V, 2.0V, 2.5V, 3.3V
- No Protection Diodes Required
- Stable with 10uF Output Capacitor
- Available with Top Tab or Tabless Package
- Available in Four Lead Configurations
- Contact MSK for MIL-PRF-38534 Qualification Status

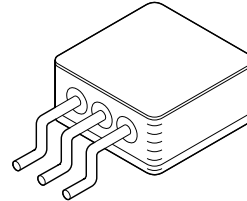

NO TAB

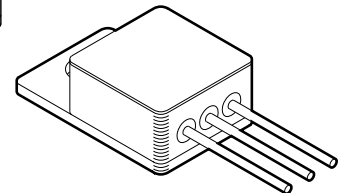

TOP TAB

DESCRIPTION:

The MSK 5140 series regulators offer a low 340mV dropout voltage while supplying to 1.5A of output current. With fast transient response, these regulators have very low output noise. Excellent line and load regulation characteristics ensure accurate performance for multiple applications. These regulators offer internal short circuit current limit, thermal limiting and reverse current protection which eliminates the need for external components and excessive derating. The MSK 5140 series regulators are available in a hermetically sealed space efficient TO-257 package with multiple lead form options.

EQUIVALENT SCHEMATIC

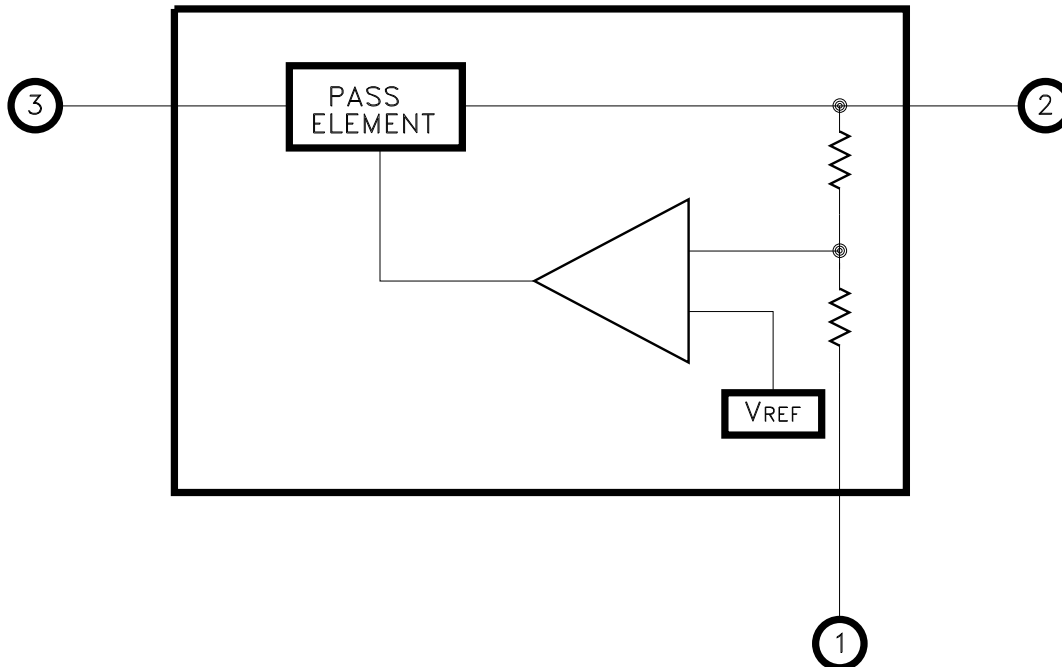

TYPICAL APPLICATIONS

- Post Regulator For Switching Power Supplies
- Battery Powered Equipment
- Microprocessor Power Supplies
- Pre-amplifier Power Supplies

PIN-OUT INFORMATION

- 1 GND
- 2 VOUT
- 3 VIN

ABSOLUTE MAXIMUM RATINGS ^⑧

IN	Supply Voltage	20V
I _{OUT}	Output Current	1.5A
V _{IN}	Differential Input Voltage	20V
T _C	Case Operating Temperature range	
	MSK 5140H.	-55°C to +125°C
	MSK 5140.	-40°C to +85°C

T _{ST}	Storage Temperature Range	-65°C to +150°C
T _{LD}	Lead Temperature Range	
	(10 Seconds).	300°C
T _J	Junction Temperature.	+150°C

ELECTRICAL SPECIFICATIONS

Parameter	Test Conditions ^①	Group A Subgroup	MSK 5140H SERIES			MSK 5140 SERIES			Units
			Min.	Typ.	Max.	Min.	Typ.	Max.	
Minimum Input Voltage ^②	I _{LOAD} = 0.5A I _{LOAD} = 1.5A	1	-	1.9	-	-	1.9	-	V
		1,2,3	-	2.1	2.5	-	2.1	2.5	V
Regulated Output Voltage	V _{IN} = (V _{OUT} + 1V) and 20V I _{LOAD} = 0mA and 1.5A	1	-1.0	-	1.0	-1.0	-	1.0	%
		2,3	-2.5	-	2.5	-	-	-	%
Line Regulation ^⑥	ΔV _{IN} = (V _{OUT} + 0.5V) to 20V I _{LOAD} = 0mA	1,2,3	-1.0	-	1.0	-1.0	-	1.0	%
Load Regulation	V _{IN} = (V _{OUT} + 1.0V) ΔI _{LOAD} = 0mA to 1.5A	1	-1.0	-	1.0	-1.0	-	1.0	%
		2,3	-1.5	-	1.5	-	-	-	%
Dropout Voltage	I _{LOAD} = 1.5A	1	-	-	0.45	-	-	0.45	V
		2,3	-	-	0.55	-	-	0.55	V
GND Pin Current ^⑦	V _{IN} = V _{OUT} + 1V, I _{LOAD} = 0mA	1,2,3	-	6.2	8.0	-	6.2	8.0	mA
Output Voltage Noise ^②	C _{OUT} = 10μF, I _{LOAD} = 1.5A BW = 10Hz to 100Hz	-	-	40	-	-	40	-	μVrms
Ripple Rejection ^②	V _{IN} - V _{OUT} = 1.5VDC, I _{LOAD} = 0.75A V _{RIPPLE} (120Hz) = 0.5Vpp	1	55	63	-	55	63	-	dB
Current Limit	V _{IN} = V _{OUT} + 1V	1,2,3	1.6	-	-	1.6	-	-	A
Reverse Output Current ^②	V _{IN} < V _{OUT}	1	-	600	1200	-	600	1200	μA
Thermal Resistance ^②	Junction to Case @ 125°C	-	-	5.6	6.5	-	5.6	6.5	°C/W

NOTES:

- ① The output is decoupled to ground using a 100μF low ESR tantalum capacitor in parallel with a 1μF ceramic capacitor. See figure 1 for typical circuit.
- ② Guaranteed by design but not tested. Typical parameters are representative of actual device performance but are for reference only.
- ③ Industrial grade devices shall be tested to subgroups 1 unless otherwise requested.
- ④ Military grade devices ("H" suffix) shall be 100% tested to subgroups 1,2 and 3.
- ⑤ Subgroup 1 TA = +25°C
Subgroup 2 TA = +125°C
Subgroup 3 TA = -55°C
- ⑥ ΔV_{IN} test condition minimum is 2.21V for the MSK 5140-1.5.
- ⑦ GND Pin Current includes a constant 5mA for the internal feedback resistor network.
- ⑧ Continuous operation at or above absolute maximum ratings may adversely effect the device performance and/or life cycle.

APPLICATION NOTES

INPUT BYPASS CAPACITORS

Unless the regulator is located very close to the main input filter capacitor, a $1\mu\text{F}$ to $10\mu\text{F}$ low ESR tantalum capacitor should be added to the regulator's input to maximize transient response and minimize power supply transients. A $0.1\mu\text{F}$ ceramic capacitor should also be used for high frequency bypassing.

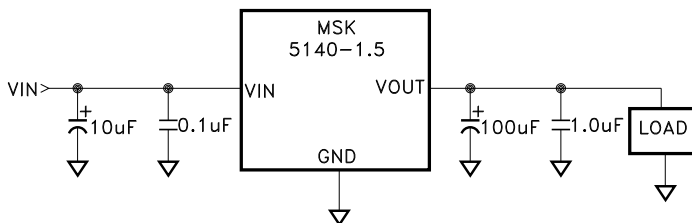

FIGURE 1

OUTPUT CAPACITOR SELECTION

For most applications a $10\mu\text{F}$ low ESR tantalum capacitor, as close to the regulators output as possible, is all that is required for the MSK 5140 to be stable. When using a $10\mu\text{F}$ capacitor on the lower output voltage devices, a minimum ESR is required of the capacitor. This requirement decreases from $20\text{m}\Omega$ on the 1.5V output regulator to $5\text{m}\Omega$ on the 3.3V output regulator. With an increase in capacitance, the minimum ESR requirement decreases. At $100\mu\text{F}$, the minimum ESR requirement decreases to $5\text{m}\Omega$ for all versions of the MSK 5140. To reduce ringing and improve transient response, capacitors with slightly larger ESR in the range of $20\text{m}\Omega$ to $50\text{m}\Omega$ provides improved damping. Capacitors with higher ESR can be combined in parallel with low ESR ceramic capacitors for good high frequency response and settling time. The maximum ESR value must be less than 3Ω . Care must be taken when selecting a ceramic type. The X5R and X7R are the best choice for output stability when considering response due to applied voltage and temperature.

REVERSE VOLTAGE PROTECTION

The regulators are protected against reverse input and output voltages. Reverse input voltages up to 20V will be blocked from the input while current flow is limited to less than 1mA. The reverse voltage on the input is also prevented from appearing on the output and the load. When the input voltage is pulled down to ground and the output is held up by a second source, the current flow between them is limited to typically $600\mu\text{A}$. See the electrical specifications table.

LOAD REGULATION

In voltage regulator applications where very large load currents are present, the load connection is very important. The path connecting the output of the regulator to the load must be extremely low impedance to avoid affecting the load regulation specifications. As shown in figure 2, any impedance (R_s) in this path will form a voltage divider with the load. For best results the ground pin should be connected directly to the load as shown in figure 2. The direct connection eliminates the effect the potential voltage drop in the power ground path can have on the internal ground sensing, thus improving load regulation. The MSK 5140 ground pin trace must be designed to carry the ground pin current without significant voltage drops. See typical performance curves.

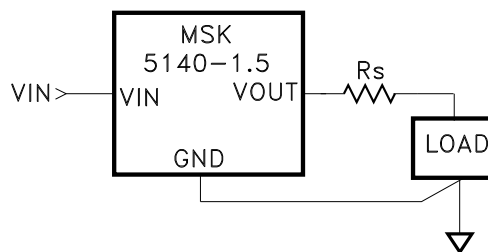

FIGURE 2

OVERLOAD PROTECTION

The MSK 5140 series regulators feature both current limit and thermal overload protection. Within the safe operating region, the regulators will current limit above their 1.6amp rating. As the input to output voltage increases, however, the current limit decreases to keep the output transistor within its power dissipation limitation. See the Current Limit Typical Curves for conditional performance detail. If the device heats enough to exceed its rated die junction temperature due to excessive ambient temperature, improper heat sinking etc., the regulators also shutdown until an appropriate junction temperature is maintained. To bring the regulator out of shutdown, the device input may need to be cycled to zero and power reapplied to eliminate the shutdown condition.

APPLICATION NOTES CONT'D

MINIMIZING POWER DISSIPATION:

To maximize the performance and reduce power dissipation of the MSK 5140 series devices, VIN should be maintained as close to dropout or at VIN minimum when possible. See Input Supply Voltage requirements. A series resistor can be used to lower VIN close to the dropout specification, lowering the input to output voltage differential. In turn, this will decrease the power that the device is required to dissipate. Knowing peak current requirements and worst case voltages, a resistor can be selected that will drop a portion of the excess voltage and help to distribute the heating. The circuit below illustrates this method.

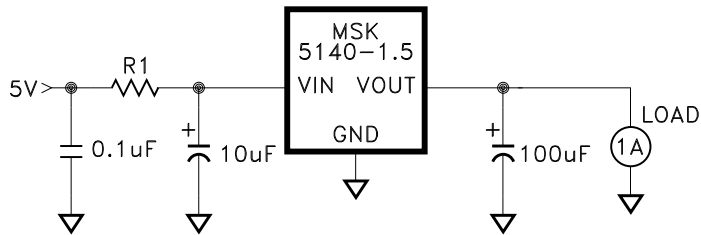

The maximum resistor value can be calculated from the following:

$$R1 \text{ max} = \frac{VIN \text{ min} - (VOUT \text{ max} + V_{DROP})}{I_{OUT \text{ peak}} + \text{GND Pin Current}}$$

Where:

VIN min = Minimum input voltage

VOUT max = Maximum output voltage across the full temperature range

V_{DRIP} = Worst case dropout voltage (Typically 430mV)

I_{OUT peak} = Maximum load current

GND Pin Current = Max. GND Pin Current at I_{OUT peak}

HEAT SINK SELECTION

To select a heat sink for the MSK 5140, the following formula for convective heat flow may be used.

Governing Equation:

$$T_J = P_D \times (R_{\theta JC} + R_{\theta CS} + R_{\theta SA}) + T_A$$

Where

T_J = Junction Temperature

P_D = Total Power Dissipation

R_{θJC} = Junction to Case Thermal Resistance

R_{θCS} = Case to Heat Sink Thermal Resistance

R_{θSA} = Heat Sink to Ambient Thermal Resistance

T_A = Ambient Temperature

$$\text{Power Dissipation} = (VIN - VOUT) \times I_{OUT}$$

Next, the user must select a maximum junction temperature. The absolute maximum allowable junction temperature is 150°C. The equation may now be rearranged to solve for the required heat sink to ambient thermal resistance (R_{θSA}).

Example:

An MSK 5140 is connected for VIN = +5V and VOUT = +3.3V. I_{OUT} is a continuous 1.0A DC level. The ambient temperature is +25°C. The maximum desired junction temperature is +125°C.

R_{θJC} = 5.6°C/W and R_{θCS} = 0.15°C/W for most thermal greases

$$\text{Power Dissipation} = (5V - 3.3V) \times (1.0A) = 1.7 \text{ Watts}$$

Solve for R_{θSA}:

$$R_{\theta SA} = \left[\frac{125^\circ\text{C} - 25^\circ\text{C}}{1.7\text{W}} \right] - 5.6^\circ\text{C/W} - 0.15^\circ\text{C/W} = 53.1^\circ\text{C/W}$$

In this example, a heat sink with a thermal resistance of no more than 53.1°C/W must be used to maintain a maximum junction temperature of no more than 125°C.

TYPICAL PERFORMANCE CURVES

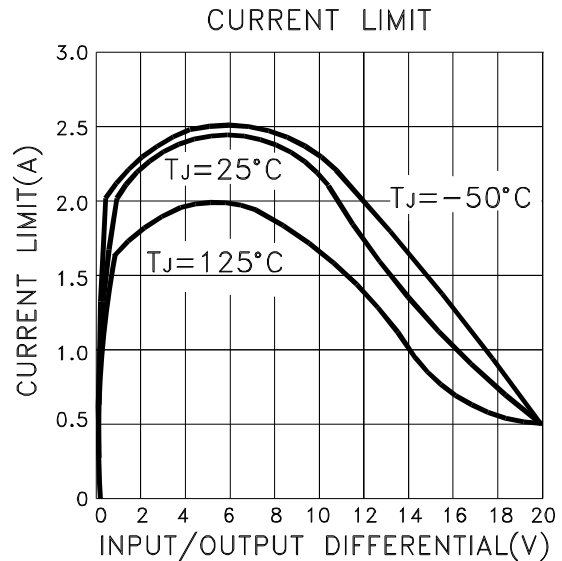
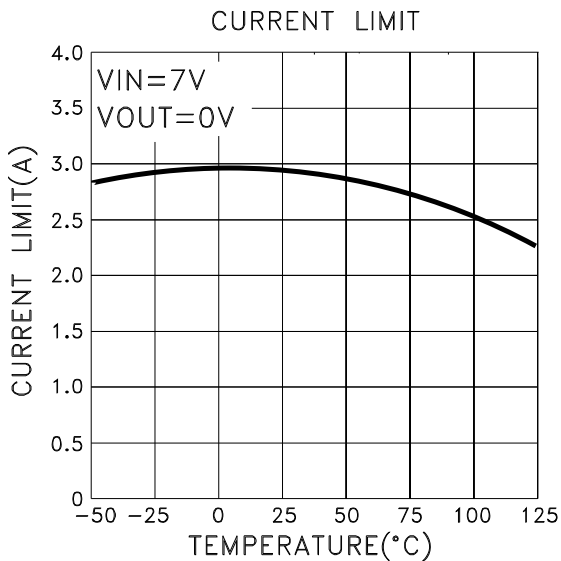
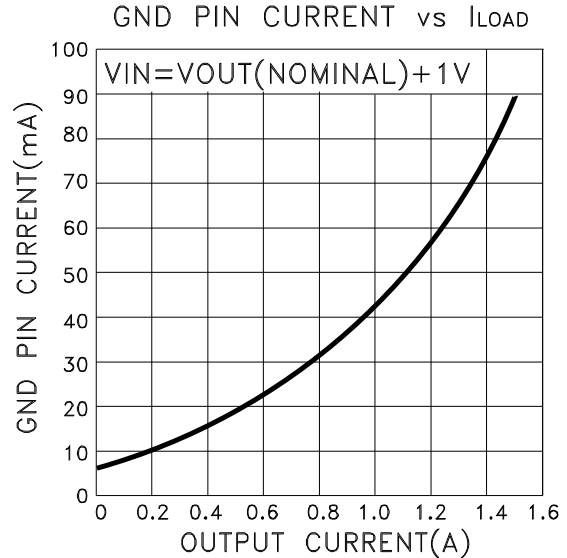
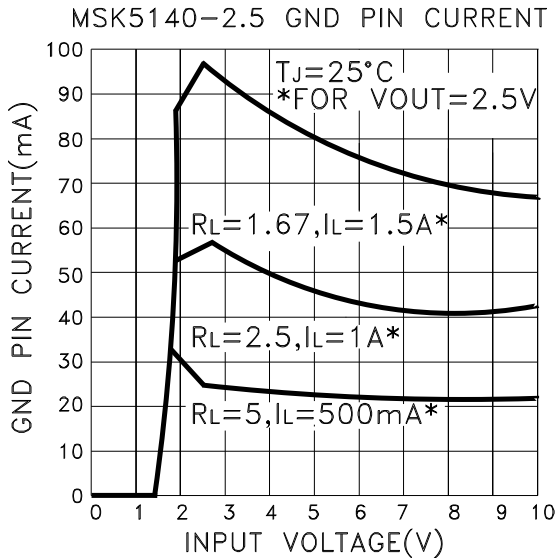
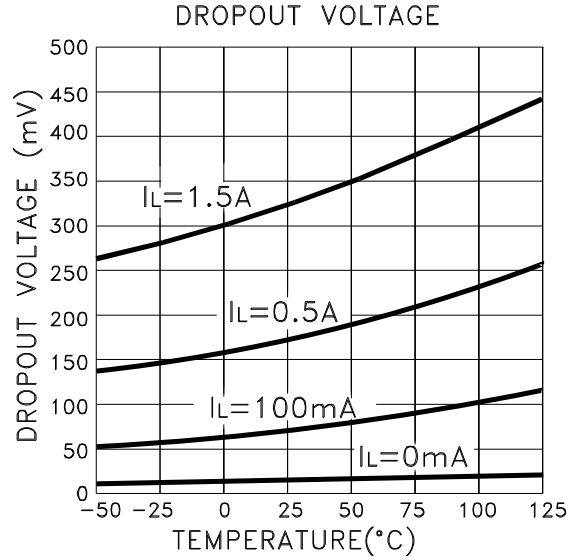
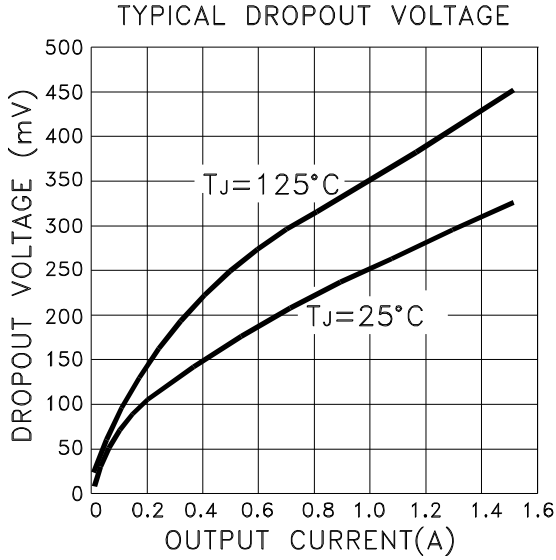

TYPICAL PERFORMANCE CURVES CONT'D

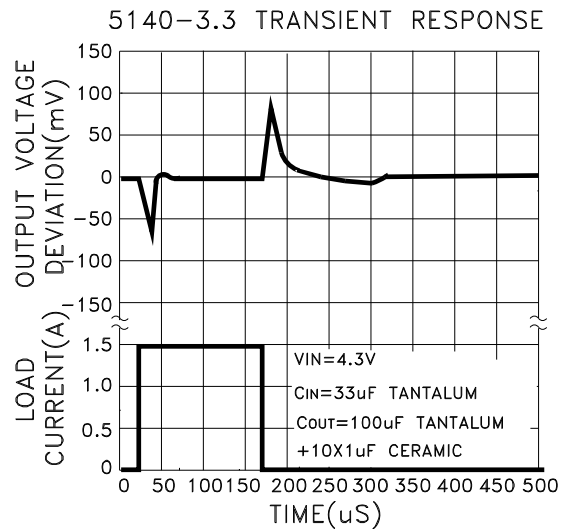
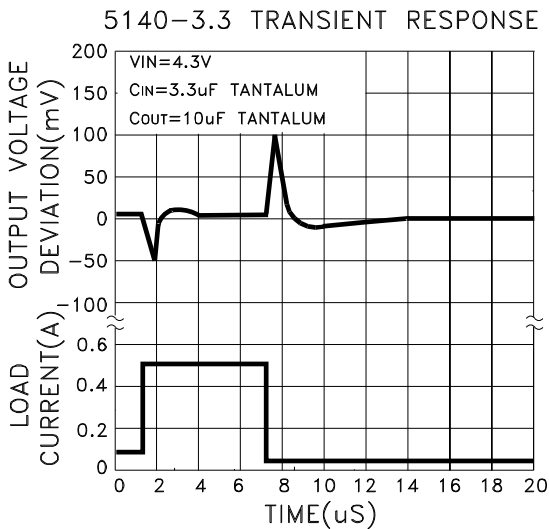
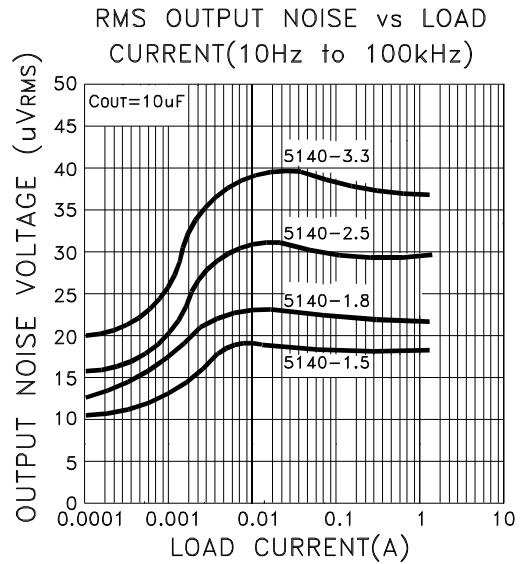
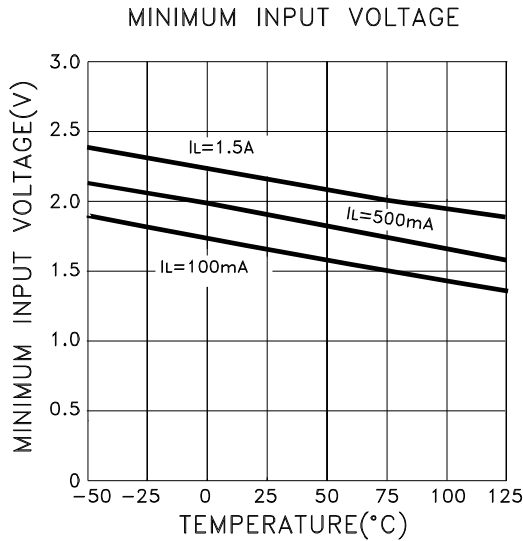
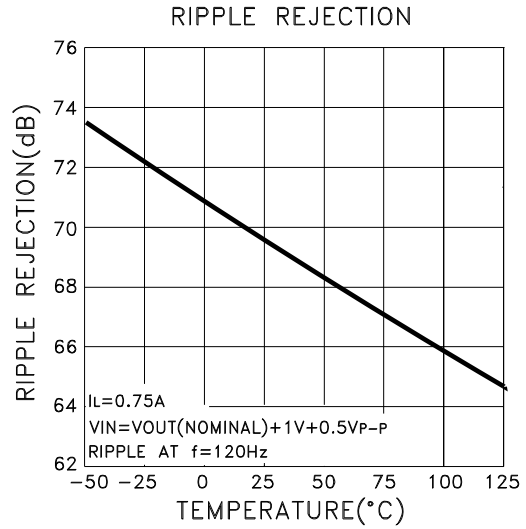
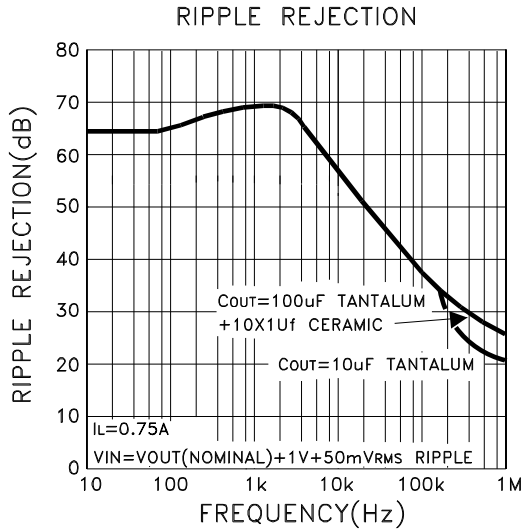

MECHANICAL SPECIFICATIONS

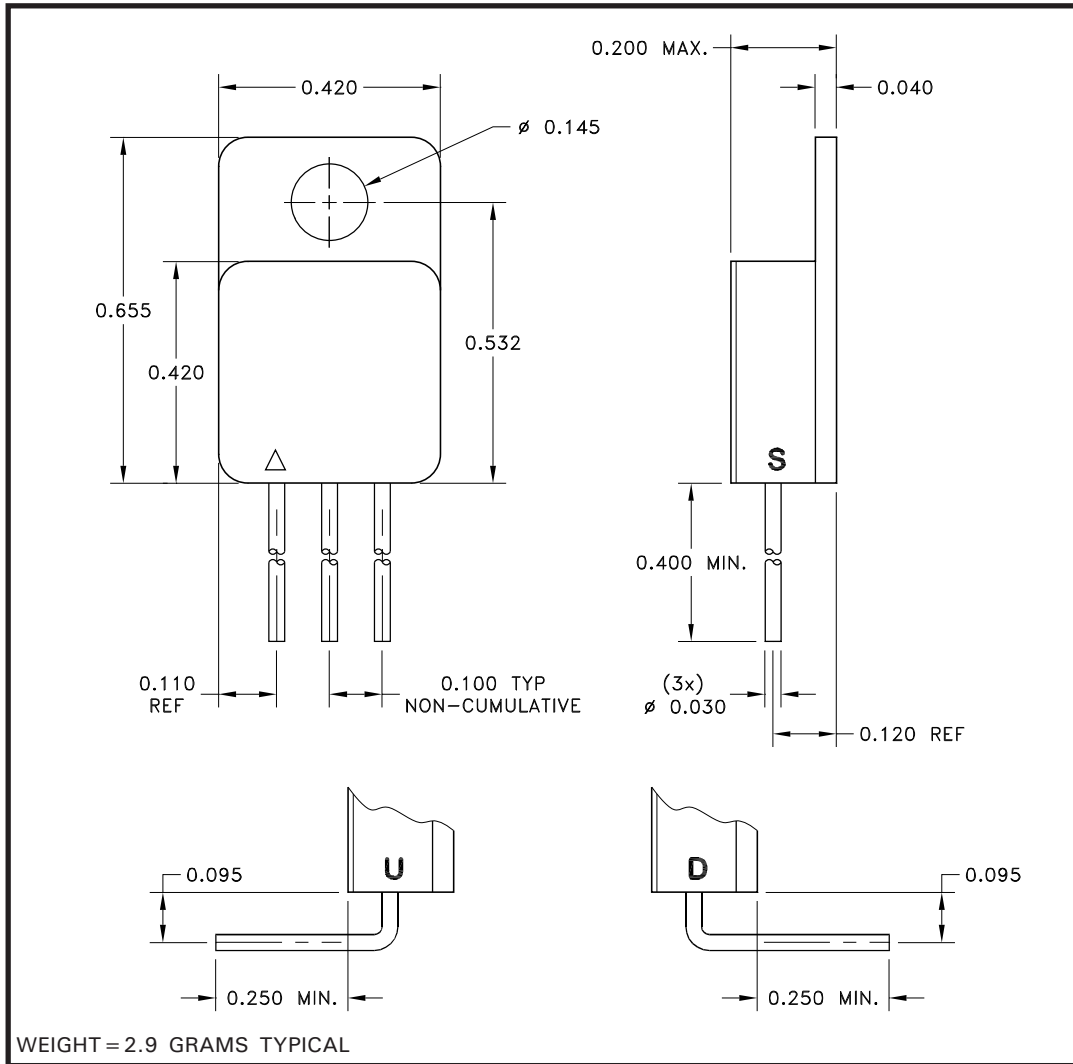

NOTE: ALL DIMENSIONS ARE ± 0.010 INCHES UNLESS OTHERWISE LABELED.
ESD Triangle Indicates Pin 1.

ORDERING INFORMATION

MSK5140-1.8 H T D

LEAD CONFIGURATIONS

(GULL WING NOT AVAILABLE WITH TOP TAB VERSION)

S = STRAIGHT; U = BENT UP; D = BENT DOWN

PACKAGE STYLE

T = TOP TAB; BLANK = NO TAB

SCREENING

BLANK = INDUSTRIAL

H = MIL-PRF-38534 CLASS H

OUTPUT VOLTAGE

1.5 = +1.5V; 1.7 = +1.7V; 1.8 = +1.8V; 1.9 = +1.9V;

2.0 = +2.0V; 2.5 = +2.5V; 3.3 = +3.3V

GENERAL PART NUMBER

MECHANICAL SPECIFICATIONS

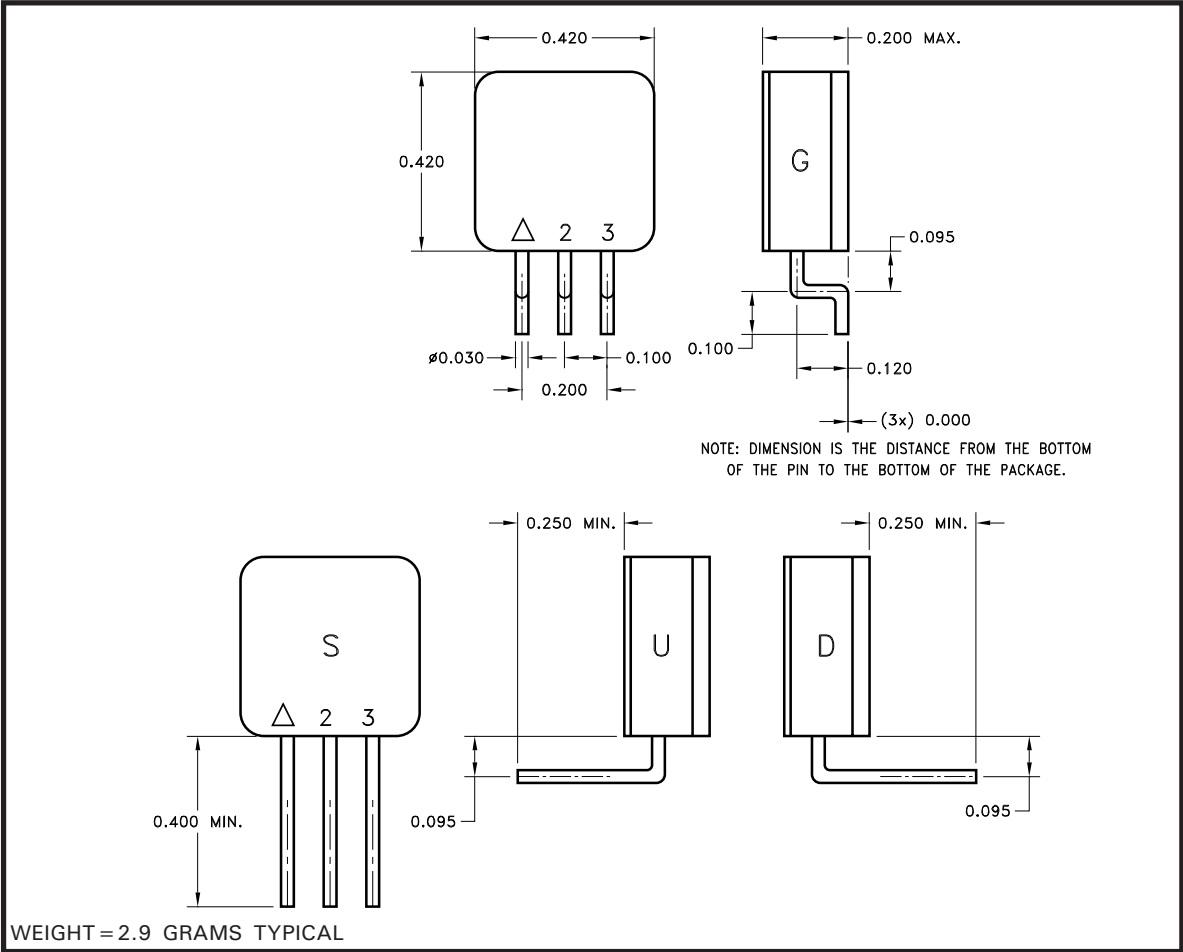

NOTE: ALL DIMENSIONS ARE ±0.010 INCHES UNLESS OTHERWISE LABELED.

ORDERING INFORMATION

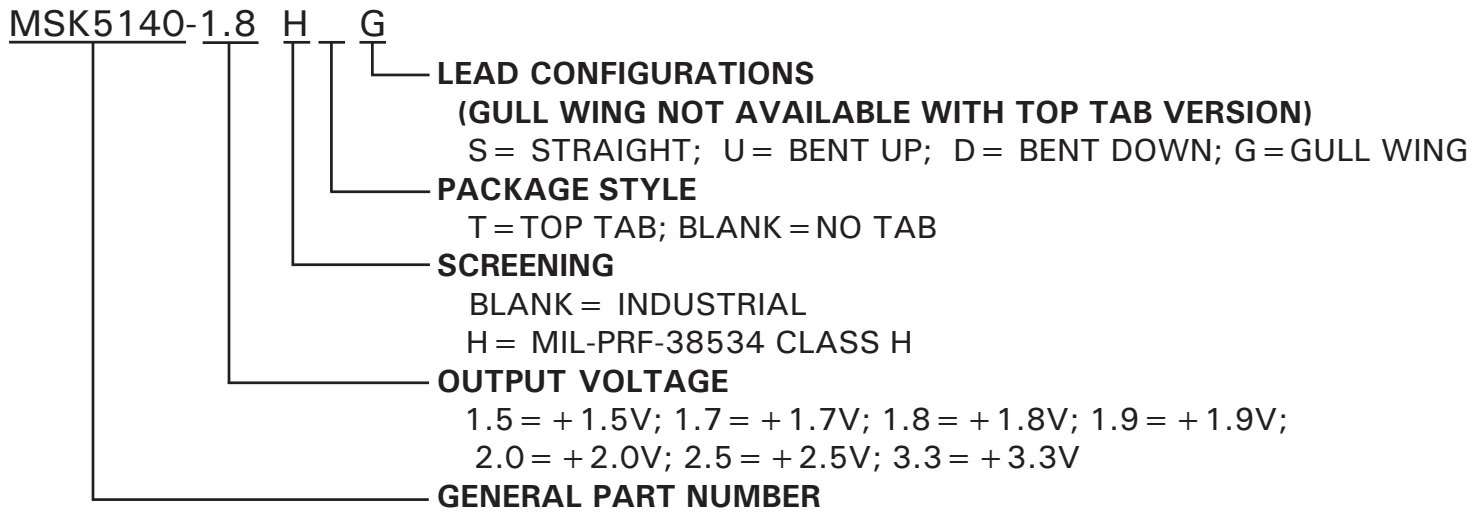

The above example is a +1.8V, Military regulator with gull wing leads.

M.S. Kennedy Corp.
 4707 Dey Road, Liverpool, New York 13088
 Phone (315) 701-6751
 FAX (315) 701-6752
www.mskennedy.com

The information contained herein is believed to be accurate at the time of printing. MSK reserves the right to make changes to its products or specifications without notice, however, and assumes no liability for the use of its products. Please visit our website for the most recent revision of this datasheet. Contact MSK for MIL-PRF-38534 qualification status.