

# Darlington Amplifier Transistors

- We declare that the material of product compliance with RoHS requirements.

## ORDERING INFORMATION

Device	Marking	Shipping
LMBTA13LT1G	1M	3000/Tape & Reel
LMBTA14LT1G	1N	3000/Tape & Reel
LMBTA13LT3G	1M	10000/Tape & Reel
LMBTA14LT3G	1N	10000/Tape & Reel

## MAXIMUM RATINGS

Rating	Symbol	Value	Unit
Collector–Emitter Voltage	$V_{CES}$	30	Vdc
Collector–Base Voltage	$V_{CBO}$	30	Vdc
Emitter–Base Voltage	$V_{EBO}$	10	Vdc
Collector Current — Continuous	$I_C$	300	mAdc

## THERMAL CHARACTERISTICS

Characteristic	Symbol	Max	Unit
Total Device Dissipation FR– 5 Board, (1) $T_A = 25^\circ\text{C}$	$P_D$	225	mW
Derate above $25^\circ\text{C}$		1.8	mW/ $^\circ\text{C}$
Thermal Resistance, Junction to Ambient	$R_{\theta JA}$	556	$^\circ\text{C}/\text{W}$
Total Device Dissipation Alumina Substrate, (2) $T_A = 25^\circ\text{C}$	$P_D$	300	mW
Derate above $25^\circ\text{C}$		2.4	mW/ $^\circ\text{C}$
Thermal Resistance, Junction to Ambient	$R_{\theta JA}$	417	$^\circ\text{C}/\text{W}$
Junction and Storage Temperature	$T_J, T_{stg}$	–55 to +150	$^\circ\text{C}$

## DEVICE MARKING

LMBTA13LT1G = 1M; LMBTA14LT1G = 1N;

## ELECTRICAL CHARACTERISTICS ( $T_A = 25^\circ\text{C}$ unless otherwise noted.)

Characteristic	Symbol	Min	Max	Unit
----------------	--------	-----	-----	------

## OFF CHARACTERISTICS

Collector–Emitter Breakdown Voltage ( $I_C = 100 \mu\text{Adc}, V_{BE} = 0$ )	$V_{(BR)CEO}$	30	—	Vdc
Collector Cutoff Current ( $V_{CB} = 30\text{Vdc}, I_E = 0$ )	$I_{CBO}$	—	100	nAdc
Emitter Cutoff Current ( $V_{EB} = 10\text{Vdc}, I_C = 0$ )	$I_{EBO}$	—	100	nAdc

1. FR–5 = 1.0 x 0.75 x 0.062 in.

2. Alumina = 0.4 x 0.3 x 0.024 in. 99.5% alumina.

**LMBTA13LT1G**  
**LMBTA14LT1G**

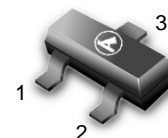

SOT–23

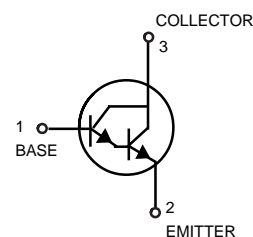

**LMBTA13LT1G LMBTA14LT1G**

**ELECTRICAL CHARACTERISTICS** ( $T_A = 25^\circ\text{C}$  unless otherwise noted) (Continued)

Characteristic	Symbol	Min	Max	Unit
<b>ON CHARACTERISTICS (3)</b>				
DC Current Gain ( $I_C = 10 \text{ mAdc}, V_{CE} = 5.0 \text{ Vdc}$ )	$h_{FE}$	5,000	—	—
	LMBTA13	5,000	—	—
	LMBTA14	10,000	—	—
( $I_C = 100 \text{ mAdc}, V_{CE} = 5.0 \text{ Vdc}$ )	LMBTA13	10,000	—	—
	LMBTA14	20,000	—	—
Collector–Emitter Saturation Voltage ( $I_C = 100 \text{ mAdc}, I_B = 0.1 \text{ mAdc}$ )	$V_{CE(sat)}$	—	1.5	Vdc
Base–Emitter On Voltage ( $I_C = 100 \text{ mAdc}, V_{CE} = 5.0 \text{ Vdc}$ )	$V_{BE}$	—	2.0	Vdc

**SMALL–SIGNAL CHARACTERISTICS**

Current – Gain–Bandwidth Product(4) ( $V_{CE} = 5.0 \text{ Vdc}, I_C = 10 \text{ mAdc}, f = 100 \text{ MHz}$ )	$f_T$	125	—	MHz
---	-------	-----	---	-----

3. Pulse Test: Pulse Width  $\leq 300 \mu\text{s}$ , Duty Cycle  $\leq 2.0\%$ .

4.  $f_T = |h_{fe}| * f_{test}$ .

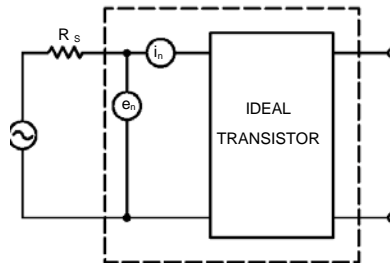
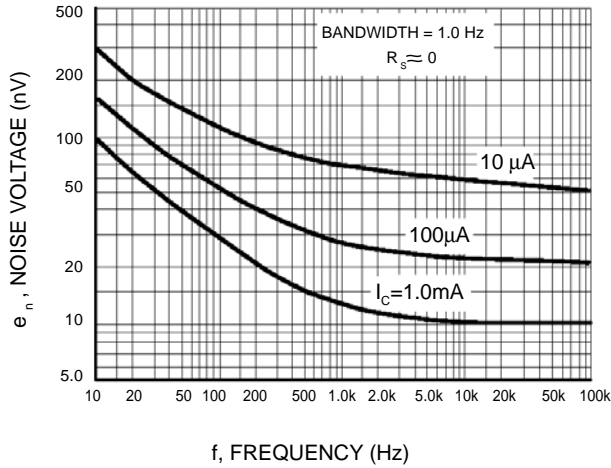

**Figure 1. Transistor Noise Model**

LMBTA13LT1G LMBTA14LT1G

**NOISE CHARACTERISTICS**

( $V_{CE} = 5.0 \text{ Vdc}$ ,  $T_A = 25^\circ\text{C}$ )



**Figure 2. Noise Voltage**

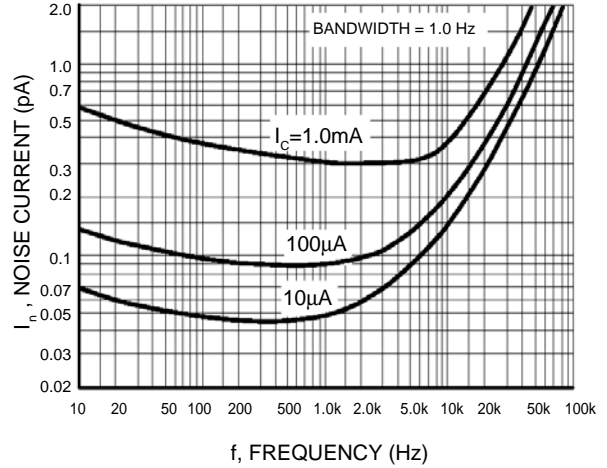

**Figure 3. Noise Current**

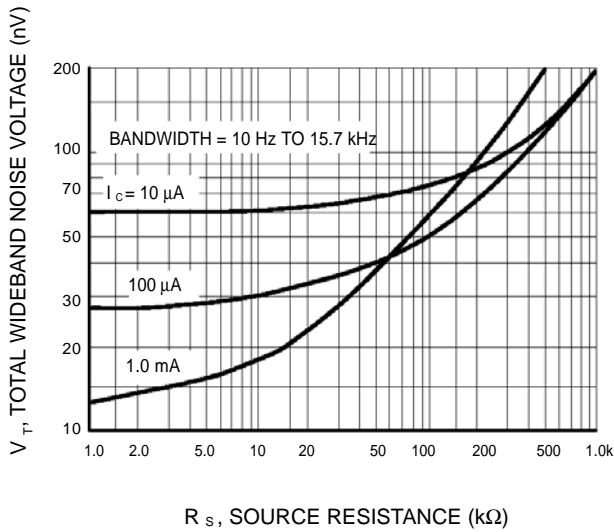

**Figure 4. Total Wideband Noise Voltage**

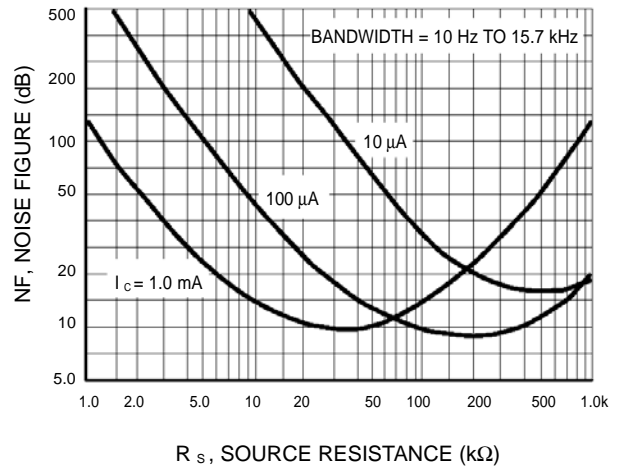

**Figure 5. Wideband Noise Figure**

LMBTA13LT1G LMBTA14LT1G

SMALL-SIGNAL CHARACTERISTICS

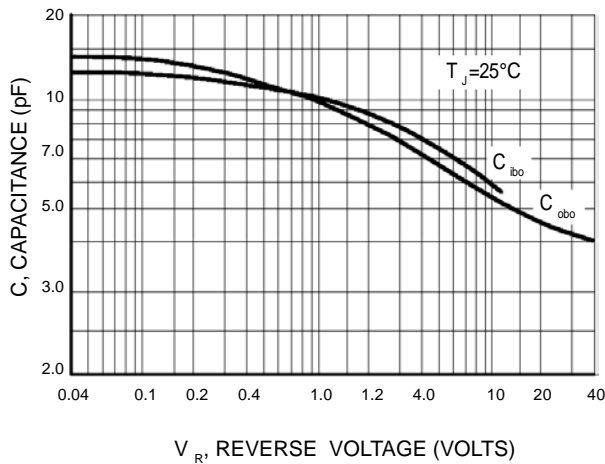

Figure 6. Capacitance

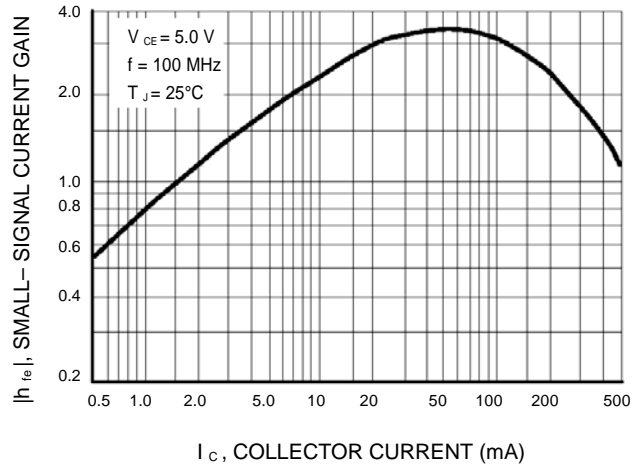

Figure 7. High Frequency Current Gain

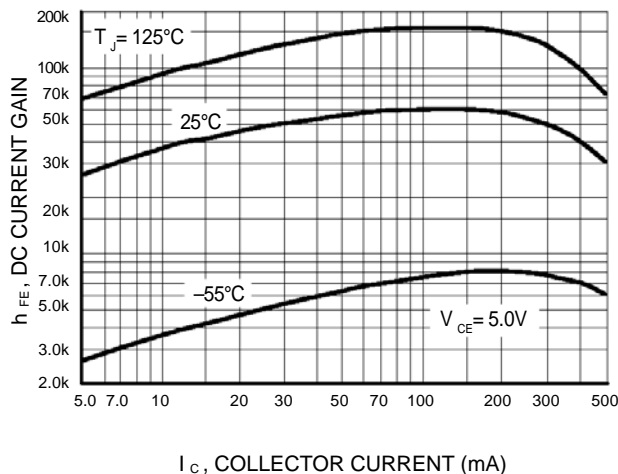

Figure 8. DC Current Gain

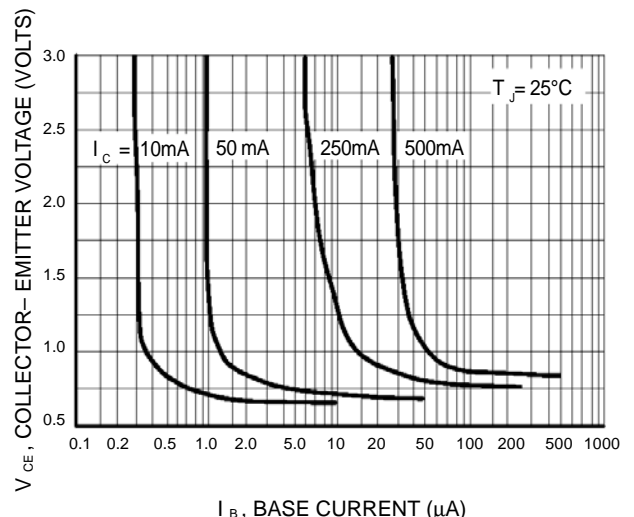

Figure 9. Collector Saturation Region

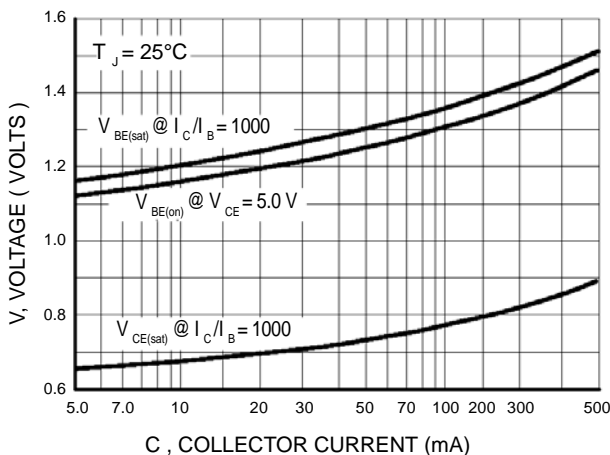

Figure 17. "ON" Voltages

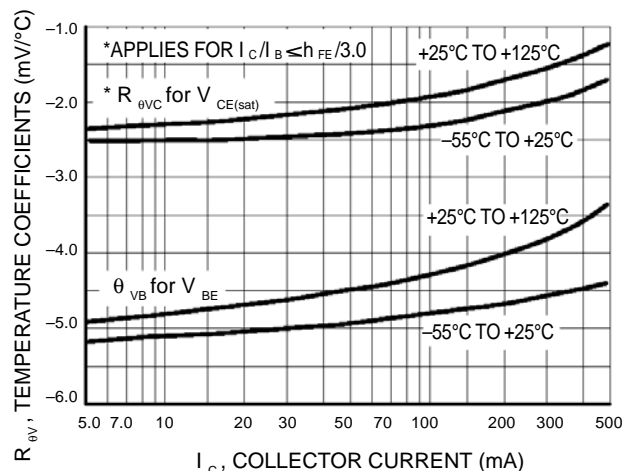

Figure 18. Temperature Coefficients

LMBTA13LT1G LMBTA14LT1G

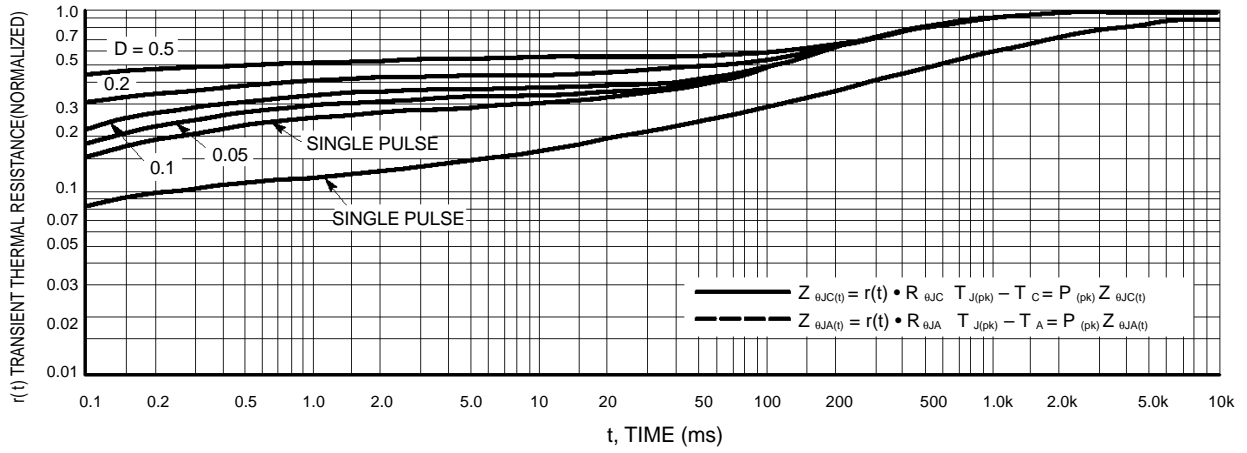

Figure 12. Thermal Response

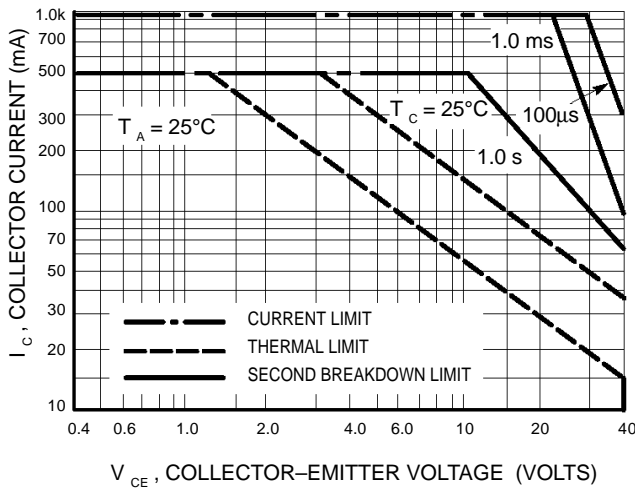
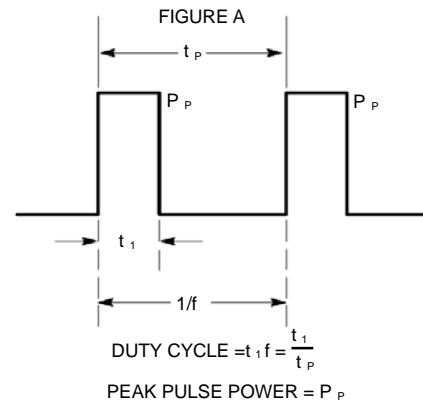

Figure 13. Active Region Safe Operating Area



**Design Note: Use of Transient Thermal Resistance Data**

LMBTA13LT1G LMBTA14LT1G

SOT-23

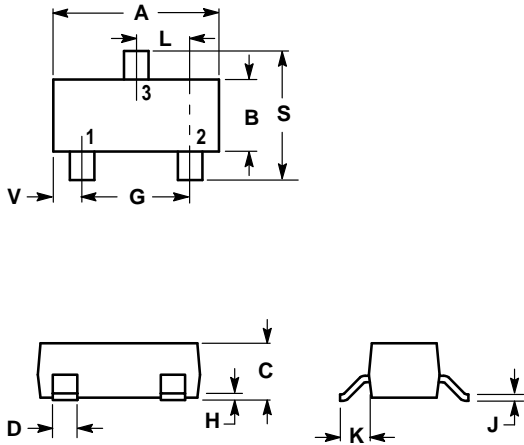

NOTES:

1. DIMENSIONING AND TOLERANCING PER ANSI Y14.5M, 1982.
2. CONTROLLING DIMENSION: INCH.

DIM	INCHES		MILLIMETERS	
	MIN	MAX	MIN	MAX
A	0.1102	0.1197	2.80	3.04
B	0.0472	0.0551	1.20	1.40
C	0.0350	0.0440	0.89	1.11
D	0.0150	0.0200	0.37	0.50
G	0.0701	0.0807	1.78	2.04
H	0.0005	0.0040	0.013	0.100
J	0.0034	0.0070	0.085	0.177
K	0.0140	0.0285	0.35	0.69
L	0.0350	0.0401	0.89	1.02
S	0.0830	0.1039	2.10	2.64
V	0.0177	0.0236	0.45	0.60

- PIN 1. BASE  
 2. EMITTER  
 3. COLLECTOR

