

# FDMS7698

## N-Channel PowerTrench® MOSFET 30 V, 22 A, 10 mΩ

### Features

- Max  $r_{DS(on)}$  = 10 mΩ at  $V_{GS} = 10$  V,  $I_D = 13.5$  A
- Max  $r_{DS(on)}$  = 15 mΩ at  $V_{GS} = 4.5$  V,  $I_D = 11.0$  A
- Advanced Package and Silicon combination for low  $r_{DS(on)}$  and high efficiency
- Next generation enhanced body diode technology, engineered for soft recovery
- MSL1 robust package design
- 100% UIL tested
- RoHS Compliant

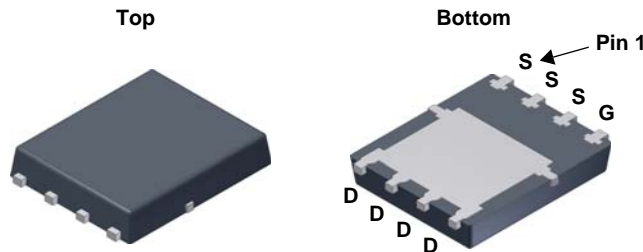


### General Description

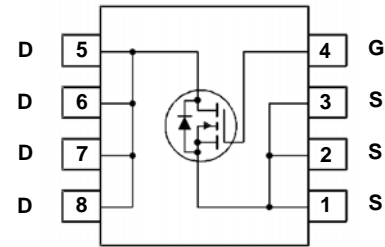
This N-Channel MOSFET has been designed specifically to improve the overall efficiency and to minimize switch node ringing of DC/DC converters using either synchronous or conventional switching PWM controllers. It has been optimized for low gate charge, low  $r_{DS(on)}$ , fast switching speed and body diode reverse recovery performance.

### Applications

- IMVP Vcore Switching for Notebook
- VRM Vcore Switching for Desktop and server
- OringFET / Load Switching
- DC-DC Conversion



Power 56



### MOSFET Maximum Ratings $T_A = 25^\circ\text{C}$ unless otherwise noted

Symbol	Parameter	Ratings	Units
$V_{DS}$	Drain to Source Voltage	30	V
$V_{GS}$	Gate to Source Voltage (Note 4)	$\pm 20$	V
$I_D$	Drain Current -Continuous (Package limited) $T_C = 25^\circ\text{C}$	22	A
	-Continuous (Silicon limited) $T_C = 25^\circ\text{C}$	44	
	-Continuous $T_A = 25^\circ\text{C}$ (Note 1a)	13.5	
	-Pulsed	50	
$E_{AS}$	Single Pulse Avalanche Energy (Note 3)	29	mJ
$P_D$	Power Dissipation $T_C = 25^\circ\text{C}$	29	W
	Power Dissipation $T_A = 25^\circ\text{C}$ (Note 1a)	2.5	
$T_J, T_{STG}$	Operating and Storage Junction Temperature Range	-55 to +150	$^\circ\text{C}$

### Thermal Characteristics

$R_{\theta JC}$	Thermal Resistance, Junction to Case	4.4	$^\circ\text{C/W}$
$R_{\theta JA}$	Thermal Resistance, Junction to Ambient (Note 1a)	50	

### Package Marking and Ordering Information

Device Marking	Device	Package	Reel Size	Tape Width	Quantity
FDMS7698	FDMS7698	Power 56	13"	12 mm	3000 units

## Electrical Characteristics $T_J = 25\text{ }^\circ\text{C}$ unless otherwise noted

Symbol	Parameter	Test Conditions	Min	Typ	Max	Units
--------	-----------	-----------------	-----	-----	-----	-------

### Off Characteristics

$BV_{DSS}$	Drain to Source Breakdown Voltage	$I_D = 250\text{ }\mu\text{A}$ , $V_{GS} = 0\text{ V}$	30			V
$\frac{\Delta BV_{DSS}}{\Delta T_J}$	Breakdown Voltage Temperature Coefficient	$I_D = 250\text{ }\mu\text{A}$ , referenced to $25\text{ }^\circ\text{C}$		16		mV/ $^\circ\text{C}$
$I_{DSS}$	Zero Gate Voltage Drain Current	$V_{DS} = 24\text{ V}$ , $V_{GS} = 0\text{ V}$			1	$\mu\text{A}$
$I_{GSS}$	Gate to Source Leakage Current, Forward	$V_{GS} = 20\text{ V}$ , $V_{DS} = 0\text{ V}$			100	nA

### On Characteristics

$V_{GS(th)}$	Gate to Source Threshold Voltage	$V_{GS} = V_{DS}$ , $I_D = 250\text{ }\mu\text{A}$	1.0	2.0	3.0	V
$\frac{\Delta V_{GS(th)}}{\Delta T_J}$	Gate to Source Threshold Voltage Temperature Coefficient	$I_D = 250\text{ }\mu\text{A}$ , referenced to $25\text{ }^\circ\text{C}$		-6		mV/ $^\circ\text{C}$
$r_{DS(on)}$	Static Drain to Source On Resistance	$V_{GS} = 10\text{ V}$ , $I_D = 13.5\text{ A}$		8.1	10	m $\Omega$
		$V_{GS} = 4.5\text{ V}$ , $I_D = 11.0\text{ A}$		12.2	15	
		$V_{GS} = 10\text{ V}$ , $I_D = 13.5\text{ A}$ $T_J = 125\text{ }^\circ\text{C}$		11	14	
$g_{FS}$	Forward Transconductance	$V_{DS} = 5\text{ V}$ , $I_D = 13.5\text{ A}$		53		S

### Dynamic Characteristics

$C_{iss}$	Input Capacitance	$V_{DS} = 15\text{ V}$ , $V_{GS} = 0\text{ V}$ , $f = 1\text{ MHz}$		1205	1605	pF
$C_{oss}$	Output Capacitance			370	495	pF
$C_{rss}$	Reverse Transfer Capacitance			35	55	pF
$R_g$	Gate Resistance		0.3	1.6	3.2	$\Omega$

### Switching Characteristics

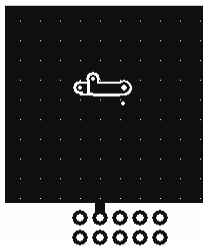
$t_{d(on)}$	Turn-On Delay Time	$V_{DD} = 15\text{ V}$ , $I_D = 13.5\text{ A}$ , $V_{GS} = 10\text{ V}$ , $R_{GEN} = 6\text{ }\Omega$		9	18	ns
$t_r$	Rise Time			3	10	ns
$t_{d(off)}$	Turn-Off Delay Time			20	36	ns
$t_f$	Fall Time			3	10	ns
$Q_g$	Total Gate Charge	$V_{GS} = 0\text{ V to }10\text{ V}$		17	24	nC
$Q_g$	Total Gate Charge	$V_{GS} = 0\text{ V to }4.5\text{ V}$	$V_{DD} = 15\text{ V}$ , $I_D = 13.5\text{ A}$	7.5	12	nC
$Q_{gs}$	Gate to Source Charge			3.9		nC
$Q_{gd}$	Gate to Drain "Miller" Charge			2.0		nC

### Drain-Source Diode Characteristics

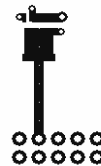
$V_{SD}$	Source to Drain Diode Forward Voltage	$V_{GS} = 0\text{ V}$ , $I_S = 2.1\text{ A}$ (Note 2)		0.75	1.1	V
		$V_{GS} = 0\text{ V}$ , $I_S = 13.5\text{ A}$ (Note 2)		0.86	1.2	
$t_{rr}$	Reverse Recovery Time	$I_F = 13.5\text{ A}$ , $di/dt = 100\text{ A}/\mu\text{s}$		24	38	ns
$Q_{rr}$	Reverse Recovery Charge			8	15	nC
$t_{rr}$	Reverse Recovery Time	$I_F = 13.5\text{ A}$ , $di/dt = 300\text{ A}/\mu\text{s}$		19	34	ns
$Q_{rr}$	Reverse Recovery Charge			13	24	nC

#### Notes:

1.  $R_{\theta JA}$  is determined with the device mounted on a  $1\text{ in}^2$  pad 2 oz copper pad on a  $1.5 \times 1.5\text{ in.}$  board of FR-4 material.  $R_{\theta JC}$  is guaranteed by design while  $R_{\theta CA}$  is determined by the user's board design.



a)  $50\text{ }^\circ\text{C/W}$  when mounted on a  $1\text{ in}^2$  pad of 2 oz copper



b)  $125\text{ }^\circ\text{C/W}$  when mounted on a minimum pad of 2 oz copper.

2. Pulse Test: Pulse Width <  $300\text{ }\mu\text{s}$ , Duty cycle <  $2.0\%$ .

3.  $E_{AS}$  of  $29\text{ mJ}$  is based on starting  $T_J = 25\text{ }^\circ\text{C}$ ,  $L = 0.3\text{ mH}$ ,  $I_{AS} = 14\text{ A}$ ,  $V_{DD} = 27\text{ V}$ ,  $V_{GS} = 10\text{ V}$ .

4. As an N-ch device, the negative Vgs rating is for low duty cycle pulse occurrence only. No continuous rating is implied.

**Typical Characteristics**  $T_J = 25\text{ }^\circ\text{C}$  unless otherwise noted

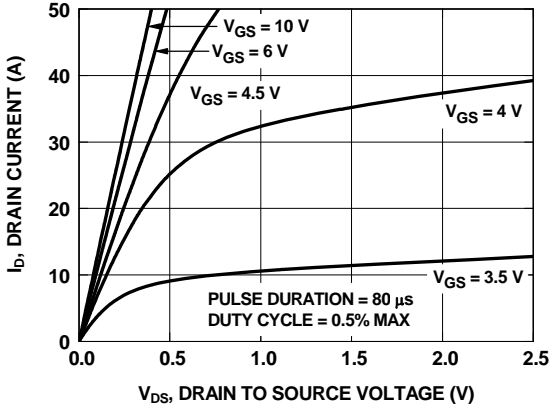


Figure 1. On-Region Characteristics

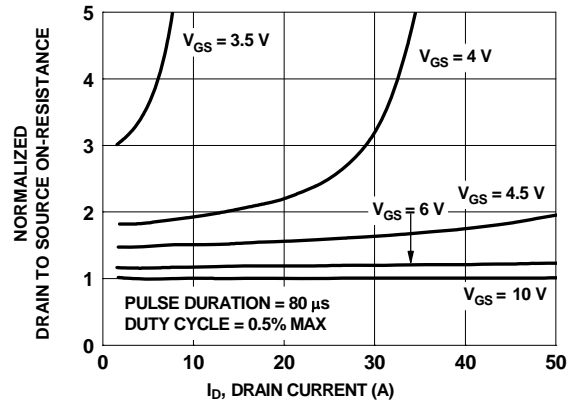


Figure 2. Normalized On-Resistance vs Drain Current and Gate Voltage

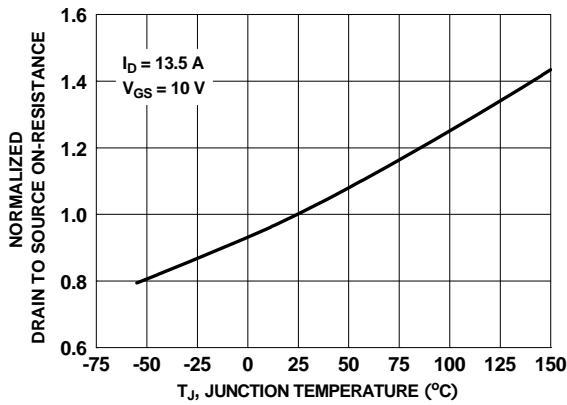


Figure 3. Normalized On-Resistance vs Junction Temperature

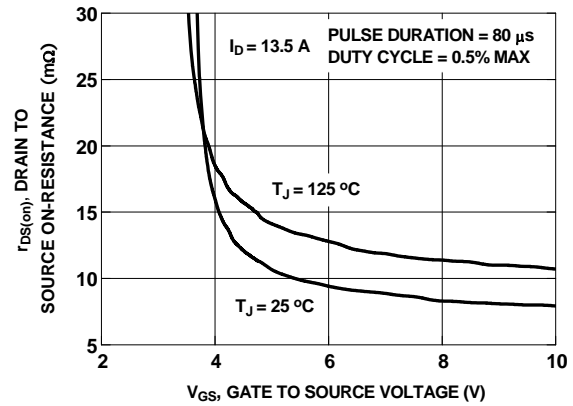


Figure 4. On-Resistance vs Gate to Source Voltage

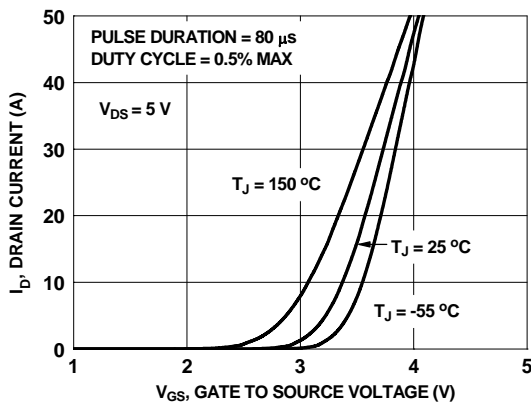


Figure 5. Transfer Characteristics

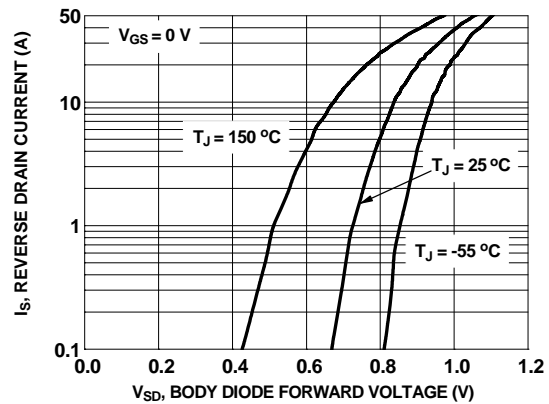
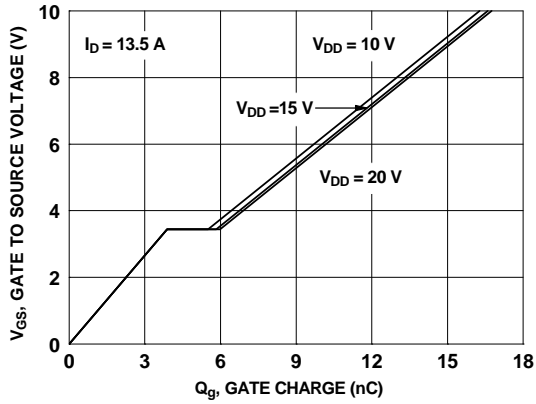
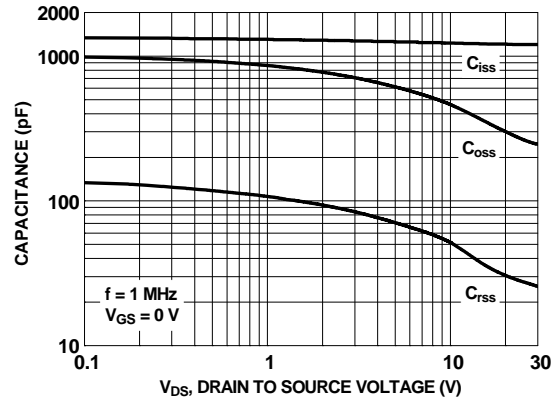


Figure 6. Source to Drain Diode Forward Voltage vs Source Current

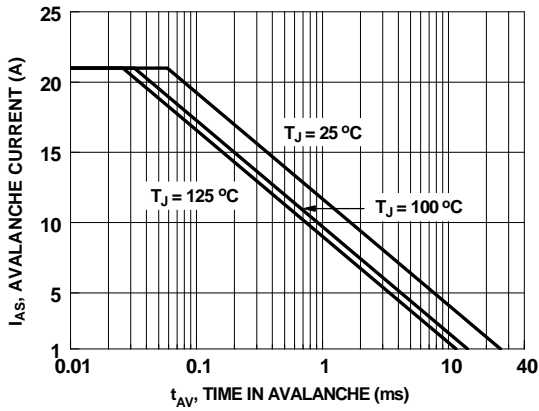
**Typical Characteristics**  $T_J = 25\text{ }^\circ\text{C}$  unless otherwise noted



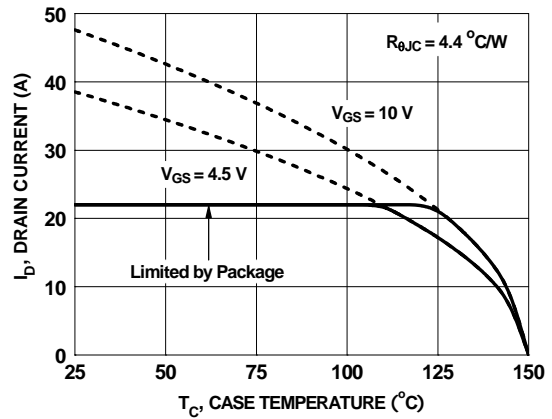
**Figure 7. Gate Charge Characteristics**



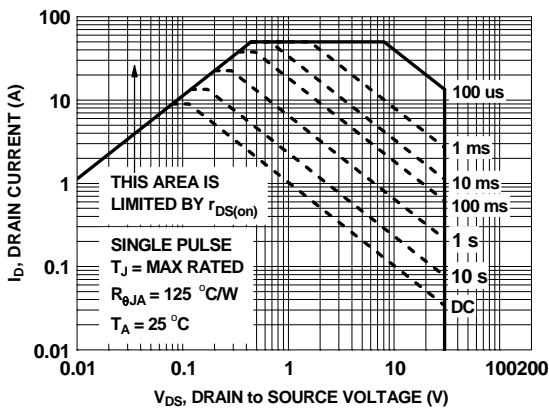
**Figure 8. Capacitance vs Drain to Source Voltage**



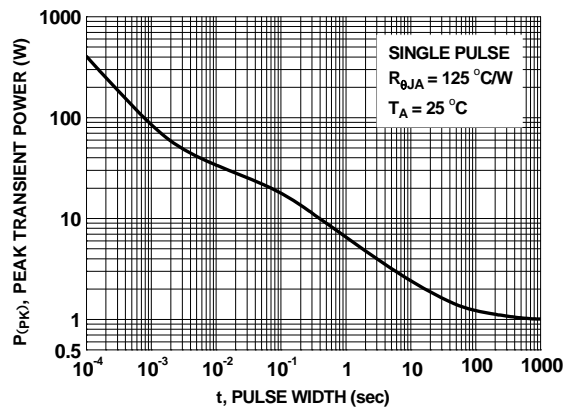
**Figure 9. Unclamped Inductive Switching Capability**



**Figure 10. Maximum Continuous Drain Current vs Case Temperature**

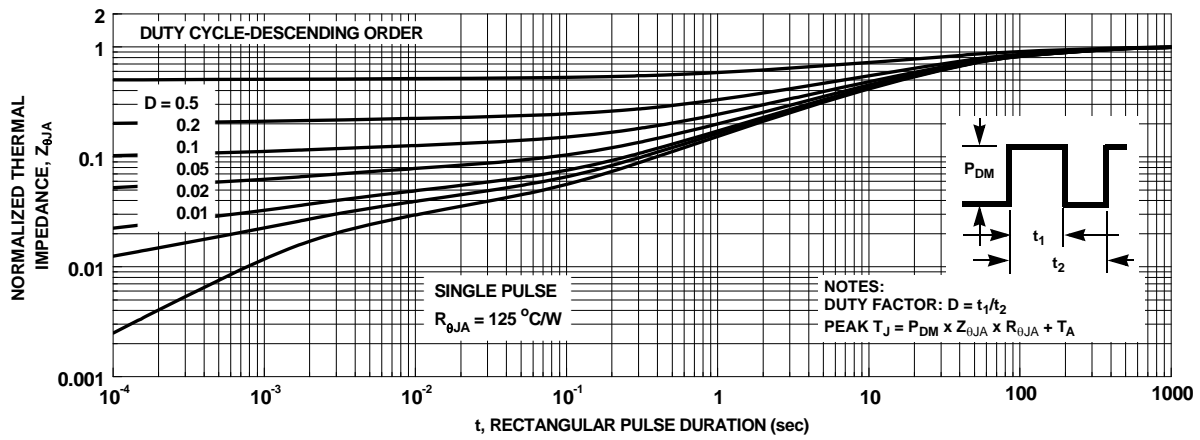


**Figure 11. Forward Bias Safe Operating Area**



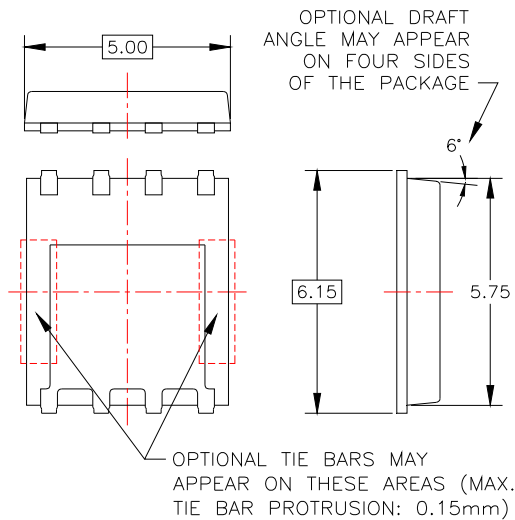
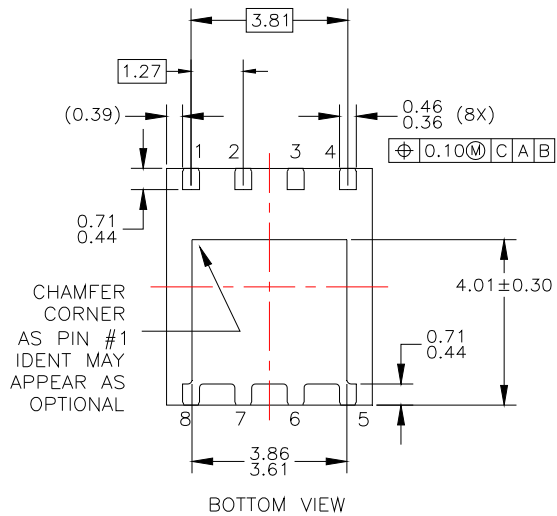
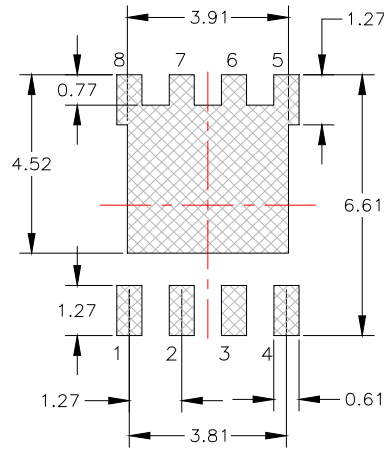
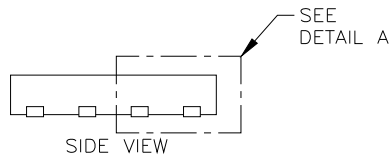
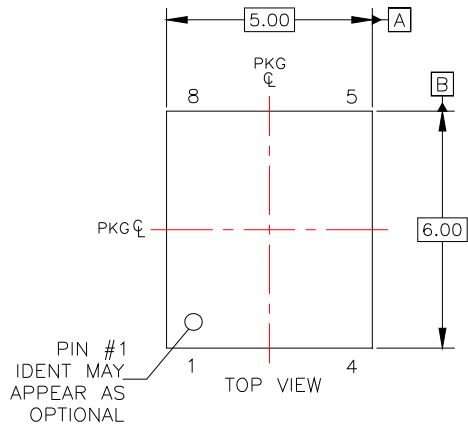
**Figure 12. Single Pulse Maximum Power Dissipation**

**Typical Characteristics**  $T_J = 25\text{ }^\circ\text{C}$  unless otherwise noted



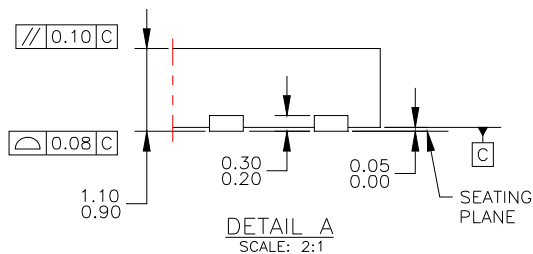
**Figure 13. Junction-to-Ambient Transient Thermal Response Curve**

## Dimensional Outline and Pad Layout



NOTES: UNLESS OTHERWISE SPECIFIED


- A) PACKAGE STANDARD REFERENCE: JEDEC MO-240, ISSUE A, VAR. AA, DATED OCTOBER 2002.
- B) ALL DIMENSIONS ARE IN MILLIMETERS.
- C) DIMENSIONS DO NOT INCLUDE BURRS OR MOLD FLASH. MOLD FLASH OR BURRS DOES NOT EXCEED 0.10MM.
- D) DIMENSIONING AND TOLERANCING PER ASME Y14.5M-1994.





**TRADEMARKS**

The following includes registered and unregistered trademarks and service marks, owned by Fairchild Semiconductor and/or its global subsidiaries, and is not intended to be an exhaustive list of all such trademarks.

- |   |   |   |   |
|---|---|---|---|
| AccuPower™  | FPS™  | Power-SPM™  | The Power Franchise®  |
| Auto-SPM™   | F-PFS™  | PowerTrench®  | The Right Technology for Your Success™  |
| AX-CAP™*  | FRFET®  | PowerXS™  |   |
| BitSic®   | Global Power Resource <sup>SM</sup>   | Programmable Active Droop™  | <b>the power</b>  |
| Build it Now™   | Green FPST™   | QFET®   | franchise™  |
| CorePLUS™   | Green FPST™ e-Series™   | QST™  | TinyBoost™  |
| CorePOWER™  | Gmax™   | Quiet Series™   | TinyBuck™   |
| CROSSVOLT™  | GTO™  | RapidConfigure™   | TinyCalc™   |
| CTL™  | IntelliMAX™   |  | TinyLogic®  |
| Current Transfer Logic™   | ISOPLANAR™  |  | TINYOPTO™   |
| DEUXPEED®   | MegaBuck™   | Saving our world, 1mW/W/kW at a time™   | TinyPower™  |
| Dual Cool™  | MICROCOUPLER™   | SignalWise™   | TinyPWM™  |
| EcoSPARK®   | MicroFET™   | SmartMax™   | TinyWire™   |
| EfficientMax™   | MicroPak™   | SMART START™  | TranSic®  |
| ESBC™   | MicroPak2™  | SPM®  | TriFault Detect™  |
|  | MillerDrive™  | STEALTH™  | TRUECURRENT®*   |
| Fairchild®  | MotionMax™  | SuperFET®   | µSerDes™  |
| Fairchild Semiconductor®  | Motion-SPM™   | SuperSOT™-3   |  |
| FACT Quiet Series™  | mWSaver™  | SuperSOT™-6   | UHC®  |
| FACT®   | OptiHiT™  | SuperSOT™-8   | Ultra FRFET™  |
| FAST®   | OPTOLOGIC®  | SupreMOS®   | UniFET™   |
| FastvCore™  | OPTOPLANAR®   | SyncFET™  | VCX™  |
| FETBench™   |  | Sync-Lock™  | VisualMax™  |
| FlashWriter®*   | PDP SPM™  |  | XS™   |

\*Trademarks of System General Corporation, used under license by Fairchild Semiconductor.

**DISCLAIMER**

FAIRCHILD SEMICONDUCTOR RESERVES THE RIGHT TO MAKE CHANGES WITHOUT FURTHER NOTICE TO ANY PRODUCTS HEREIN TO IMPROVE RELIABILITY, FUNCTION, OR DESIGN. FAIRCHILD DOES NOT ASSUME ANY LIABILITY ARISING OUT OF THE APPLICATION OR USE OF ANY PRODUCT OR CIRCUIT DESCRIBED HEREIN; NEITHER DOES IT CONVEY ANY LICENSE UNDER ITS PATENT RIGHTS, NOR THE RIGHTS OF OTHERS. THESE SPECIFICATIONS DO NOT EXPAND THE TERMS OF FAIRCHILD'S WORLDWIDE TERMS AND CONDITIONS, SPECIFICALLY THE WARRANTY THEREIN, WHICH COVERS THESE PRODUCTS.

**LIFE SUPPORT POLICY**

FAIRCHILD'S PRODUCTS ARE NOT AUTHORIZED FOR USE AS CRITICAL COMPONENTS IN LIFE SUPPORT DEVICES OR SYSTEMS WITHOUT THE EXPRESS WRITTEN APPROVAL OF FAIRCHILD SEMICONDUCTOR CORPORATION.

As used here in:

- Life support devices or systems are devices or systems which, (a) are intended for surgical implant into the body or (b) support or sustain life, and (c) whose failure to perform when properly used in accordance with instructions for use provided in the labeling, can be reasonably expected to result in a significant injury of the user.
- A critical component in any component of a life support, device, or system whose failure to perform can be reasonably expected to cause the failure of the life support device or system, or to affect its safety or effectiveness.

**ANTI-COUNTERFEITING POLICY**

Fairchild Semiconductor Corporation's Anti-Counterfeiting Policy. Fairchild's Anti-Counterfeiting Policy is also stated on our external website, www.Fairchildsemi.com, under Sales Support.

Counterfeiting of semiconductor parts is a growing problem in the industry. All manufactures of semiconductor products are experiencing counterfeiting of their parts. Customers who inadvertently purchase counterfeit parts experience many problems such as loss of brand reputation, substandard performance, failed application, and increased cost of production and manufacturing delays. Fairchild is taking strong measures to protect ourselves and our customers from the proliferation of counterfeit parts. Fairchild strongly encourages customers to purchase Fairchild parts either directly from Fairchild or from Authorized Fairchild Distributors who are listed by country on our web page cited above. Products customers buy either from Fairchild directly or from Authorized Fairchild Distributors are genuine parts, have full traceability, meet Fairchild's quality standards for handling and storage and provide access to Fairchild's full range of up-to-date technical and product information. Fairchild and our Authorized Distributors will stand behind all warranties and will appropriately address and warranty issues that may arise. Fairchild will not provide any warranty coverage or other assistance for parts bought from Unauthorized Sources. Fairchild is committed to combat this global problem and encourage our customers to do their part in stopping this practice by buying direct or from authorized distributors.

**PRODUCT STATUS DEFINITIONS**

**Definition of Terms**

Datasheet Identification	Product Status	Definition
Advance Information	Formative / In Design	Datasheet contains the design specifications for product development. Specifications may change in any manner without notice.
Preliminary	First Production	Datasheet contains preliminary data; supplementary data will be published at a later date. Fairchild Semiconductor reserves the right to make changes at any time without notice to improve design.
No Identification Needed	Full Production	Datasheet contains final specifications. Fairchild Semiconductor reserves the right to make changes at any time without notice to improve the design.
Obsolete	Not In Production	Datasheet contains specifications on a product that is discontinued by Fairchild Semiconductor. The datasheet is for reference information only.

Rev. I54