

**ISOTOP® Boost chopper
Trench IGBT**

**$V_{CES} = 1200V$
 $I_C = 50A @ T_c = 80^\circ C$**

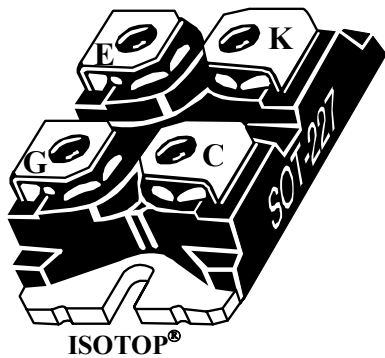
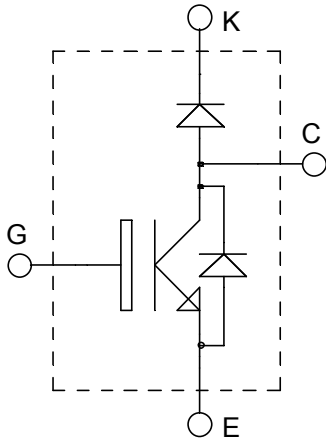

Application

- AC and DC motor control
- Switched Mode Power Supplies
- Power Factor Correction
- Brake switch

Features

- Trench + Field Stop IGBT® Technology
 - Low voltage drop
 - Low tail current
 - Switching frequency up to 20 kHz
 - Soft recovery parallel diodes
 - Low diode VF
 - Low leakage current
 - Avalanche energy rated
 - RBSOA and SCSOA rated
- ISOTOP® Package (SOT-227)
- Very low stray inductance
- High level of integration

Benefits

- Low conduction losses
- Stable temperature behavior
- Very rugged
- Direct mounting to heatsink (isolated package)
- Low junction to case thermal resistance
- Easy paralleling due to positive TC of VCEsat

Absolute maximum ratings

Symbol	Parameter	Max ratings	Unit
V_{CES}	Collector - Emitter Breakdown Voltage	1200	V
I_{C1}	Continuous Collector Current	$T_C = 25^\circ C$	75
I_{C2}		$T_C = 80^\circ C$	50
I_{CM}	Pulsed Collector Current	$T_C = 25^\circ C$	100
V_{GE}	Gate - Emitter Voltage	± 20	V
P_D	Maximum Power Dissipation	$T_C = 25^\circ C$	347
I_{FAV}	Maximum Average Forward Current	Duty cycle=0.5	$T_C = 80^\circ C$
I_{FRMS}	RMS Forward Current (Square wave, 50% duty)		34

CAUTION: These Devices are sensitive to Electrostatic Discharge. Proper Handling Procedures Should Be Followed.

All ratings @ $T_j = 25^\circ\text{C}$ unless otherwise specified

Electrical Characteristics

Symbol	Characteristic	Test Conditions	Min	Typ	Max	Unit	
BV_{CES}	Collector - Emitter Breakdown Voltage	$V_{GE} = 0V, I_C = 3mA$	1200			V	
I_{CES}	Zero Gate Voltage Collector Current	$V_{GE} = 0V, V_{CE} = 1200V$			5	mA	
$V_{CE(on)}$	Collector Emitter on Voltage	$V_{GE} = 15V$ $I_C = 50A$	$T_j = 25^\circ\text{C}$	1.4	1.7	2.1	V
			$T_j = 125^\circ\text{C}$		2.0		
$V_{GE(th)}$	Gate Threshold Voltage	$V_{GE} = V_{CE}, I_C = 2mA$	5.0		6.5	V	
I_{GES}	Gate - Emitter Leakage Current	$V_{GE} = \pm 20V, V_{CE} = 0V$			500	nA	

Dynamic Characteristics

Symbol	Characteristic	Test Conditions	Min	Typ	Max	Unit	
C_{ies}	Input Capacitance	$V_{GE} = 0V$ $V_{CE} = 25V$ $f = 1MHz$		3600		pF	
C_{oes}	Output Capacitance			188			
C_{res}	Reverse Transfer Capacitance			163			
$T_{d(on)}$	Turn-on Delay Time	Resistive Switching (25°C) $V_{GE} = 15V$ $V_{Bus} = 600V$ $I_C = 50A$ $R_G = 18\Omega$		85		ns	
T_r	Rise Time			30			
$T_{d(off)}$	Turn-off Delay Time			420			
T_f	Fall Time			65			
$T_{d(on)}$	Turn-on Delay Time	Inductive Switching (125°C) $V_{GE} = 15V$ $V_{Bus} = 600V$ $I_C = 50A$ $R_G = 18\Omega$		90		ns	
T_r	Rise Time			45			
$T_{d(off)}$	Turn-off Delay Time			520			
T_f	Fall Time			90			
E_{on}	Turn-on Switching Energy			6.6			mJ
E_{off}	Turn-off Switching Energy			5.8			

Diode ratings and characteristics

Symbol	Characteristic	Test Conditions	Min	Typ	Max	Unit
V_F	Diode Forward Voltage	$I_F = 30A$		2.0	2.5	V
		$I_F = 60A$		2.3		
		$I_F = 30A$	$T_j = 125^\circ C$		1.8	
I_{RM}	Maximum Reverse Leakage Current	$V_R = 1200V$			250	μA
		$V_R = 1200V$	$T_j = 125^\circ C$		500	
C_T	Junction Capacitance	$V_R = 200V$		32		pF
t_{rr}	Reverse Recovery Time	$I_F = 1A, V_R = 30V$ $di/dt = 100A/\mu s$	$T_j = 25^\circ C$		31	ns
	Reverse Recovery Time		$T_j = 25^\circ C$		370	
			$T_j = 125^\circ C$		500	
I_{RRM}	Maximum Reverse Recovery Current	$I_F = 30A$ $V_R = 800V$ $di/dt = 200A/\mu s$	$T_j = 25^\circ C$		5	A
			$T_j = 125^\circ C$		12	
			$T_j = 25^\circ C$		660	
Q_{rr}	Reverse Recovery Charge		$T_j = 25^\circ C$		3450	nC
			$T_j = 125^\circ C$		37	
t_{rr}	Reverse Recovery Time	$I_F = 30A$	$T_j = 125^\circ C$		220	ns
Q_{rr}	Reverse Recovery Charge	$V_R = 800V$			4650	nC
I_{RRM}	Maximum Reverse Recovery Current	$di/dt = 1000A/\mu s$			37	A

Thermal and package characteristics

Symbol	Characteristic	Min	Typ	Max	Unit	
R_{thJC}	Junction to Case	IGBT			0.36	$^\circ C/W$
		Diode			1.1	
R_{thJA}	Junction to Ambient (IGBT & Diode)			20	$^\circ C/W$	
V_{ISOL}	RMS Isolation Voltage, any terminal to case $t = 1$ min, $I_{isol} < 1mA$, 50/60Hz	2500			V	
T_j, T_{STG}	Storage Temperature Range	-55		150	$^\circ C$	
T_L	Max Lead Temp for Soldering: 0.063" from case for 10 sec			300		
Torque	Mounting torque (Mounting = 8-32 or 4mm Machine and terminals = 4mm Machine)			1.5	N.m	
Wt	Package Weight		29.2		g	

Typical IGBT Performance Curve

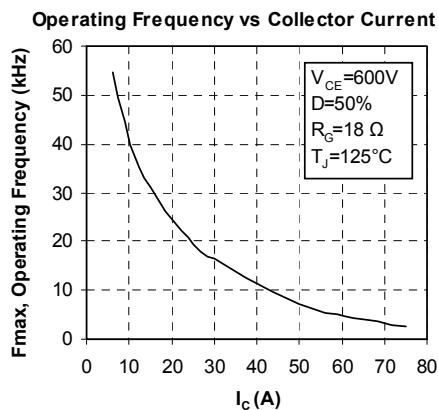

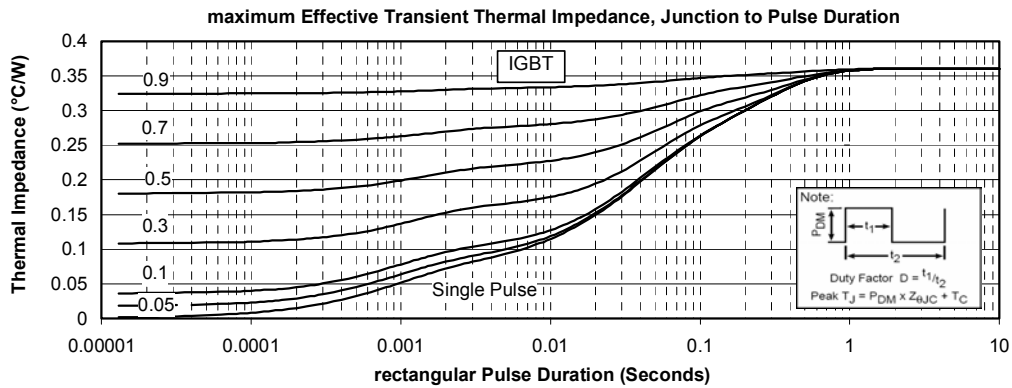
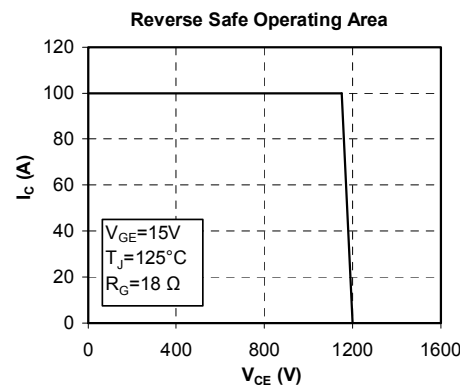
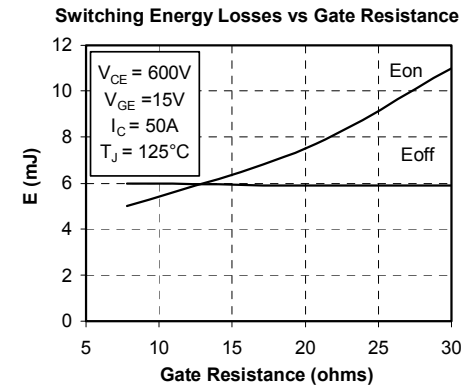
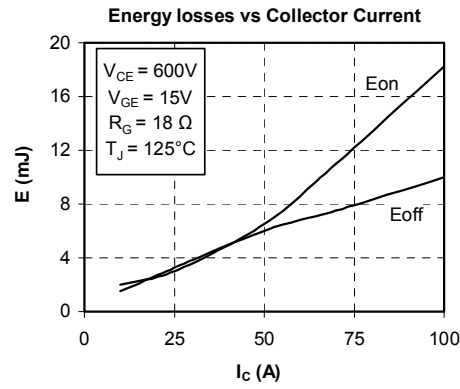
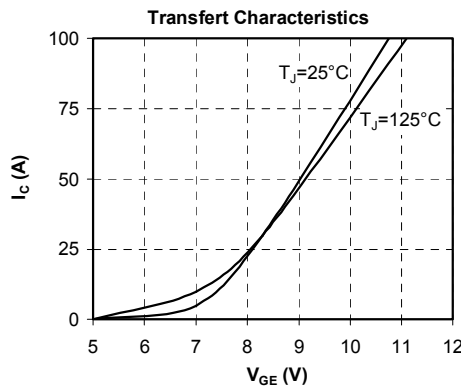
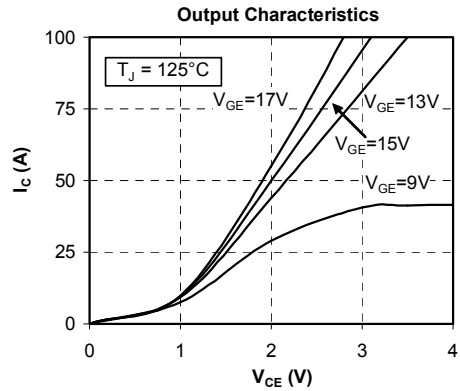
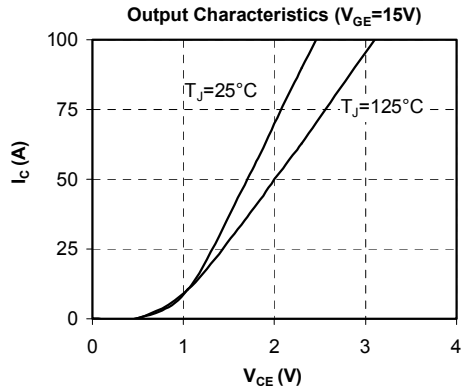

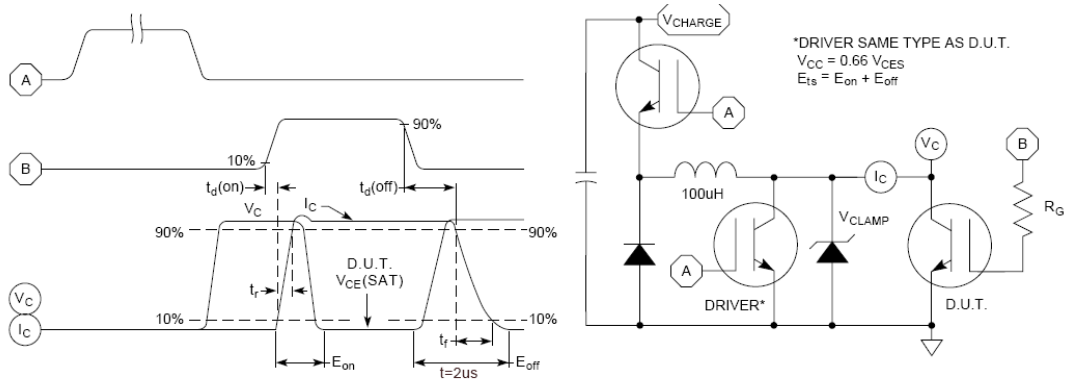

Figure 15, Switching Loss Test Circuit and Waveforms

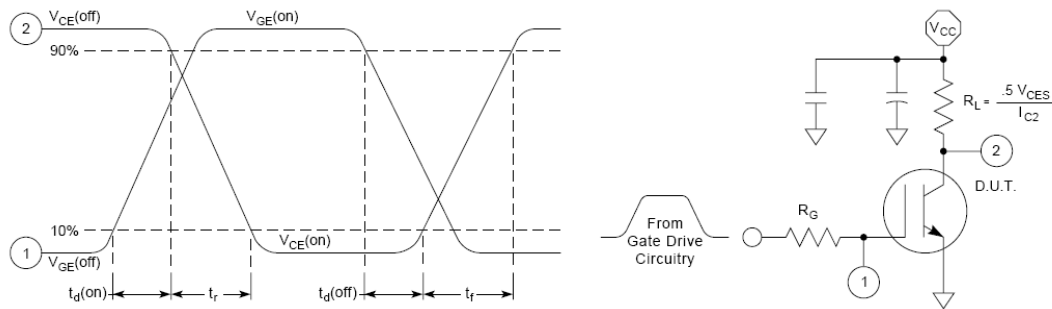

Figure 16, Resistive Switching Time Test Circuit and Waveforms

Typical Diode Performance Curve

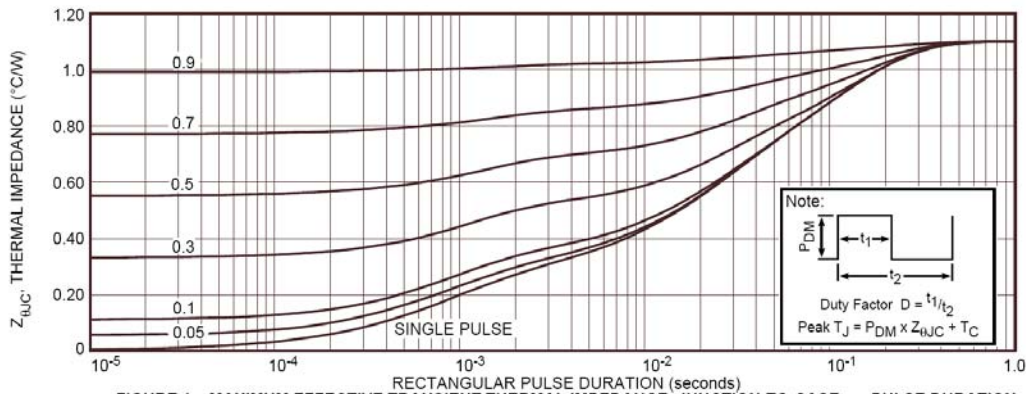

FIGURE 1a. MAXIMUM EFFECTIVE TRANSIENT THERMAL IMPEDANCE, JUNCTION-TO-CASE vs. PULSE DURATION

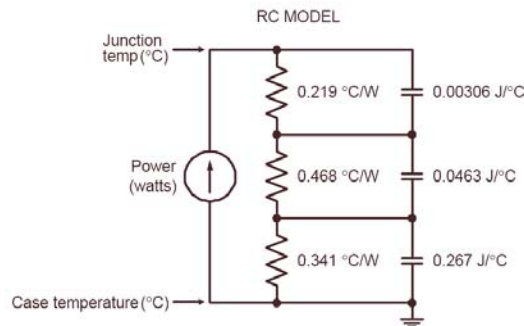

FIGURE 1b, TRANSIENT THERMAL IMPEDANCE MODEL

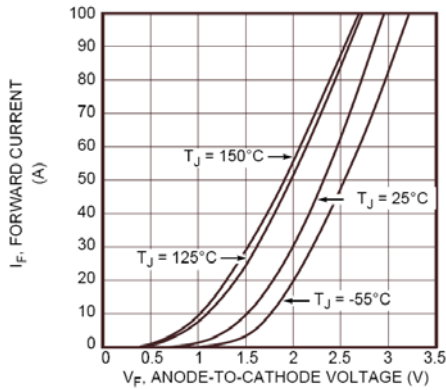

Figure 2. Forward Current vs. Forward Voltage

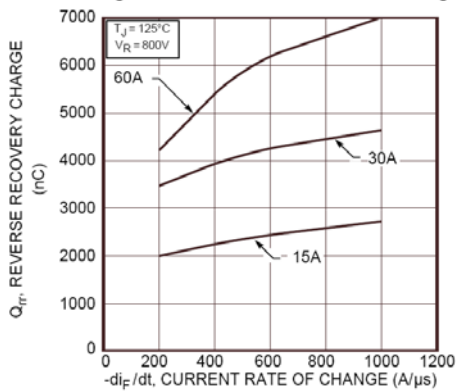

Figure 4. Reverse Recovery Charge vs. Current Rate of Change

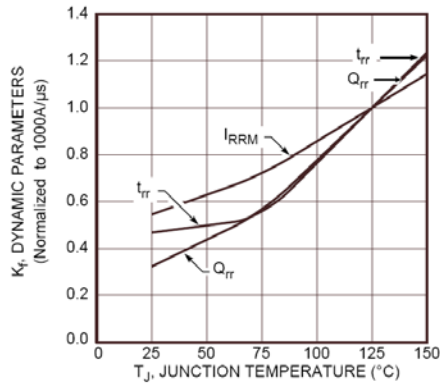

Figure 6. Dynamic Parameters vs. Junction Temperature

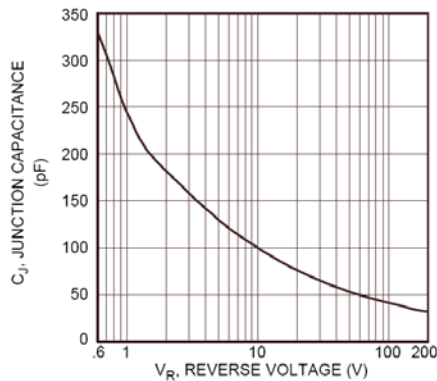

Figure 8. Junction Capacitance vs. Reverse Voltage

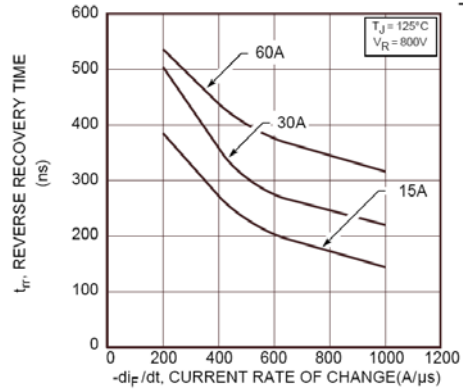

Figure 3. Reverse Recovery Time vs. Current Rate of Change

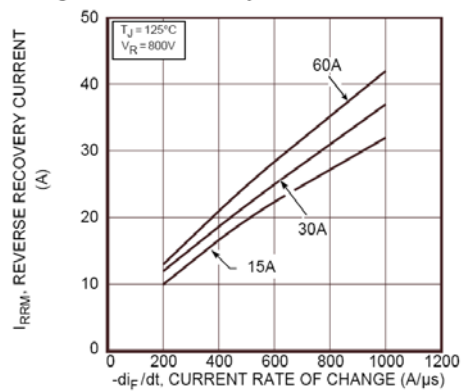

Figure 5. Reverse Recovery Current vs. Current Rate of Change

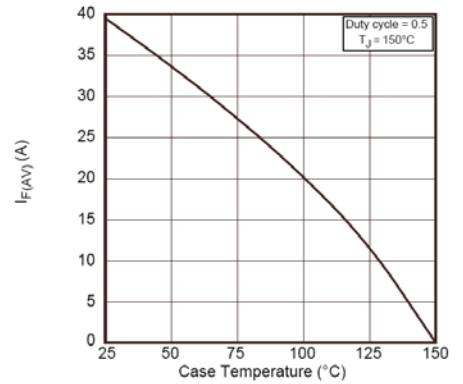

Figure 7. Maximum Average Forward Current vs. Case Temperature

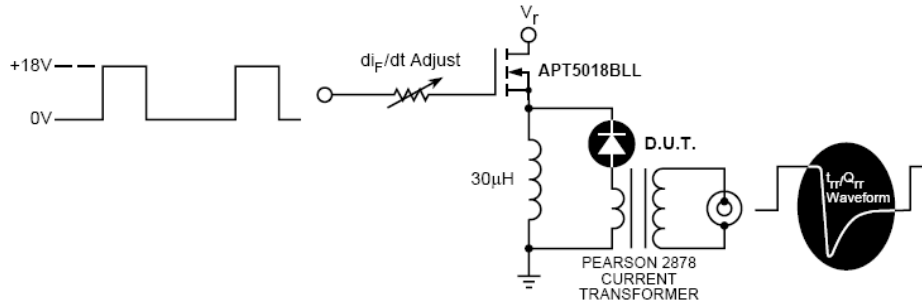

Figure 9. Diode Test Circuit

- ❶ I_F - Forward Conduction Current
- ❷ di_F/dt - Rate of Diode Current Change Through Zero Crossing.
- ❸ I_{RRM} - Maximum Reverse Recovery Current.
- ❹ t_{TR} - Reverse Recovery Time, measured from zero crossing where diode current goes from positive to negative, to the point at which the straight line through I_{RRM} and $0.25 \cdot I_{RRM}$ passes through zero.
- ❺ Q_{TR} - Area Under the Curve Defined by I_{RRM} and t_{TR} .

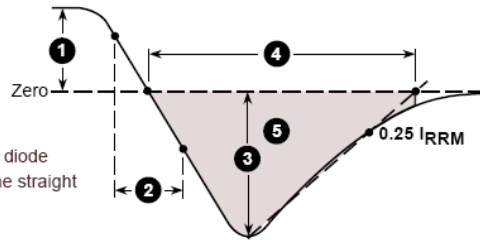
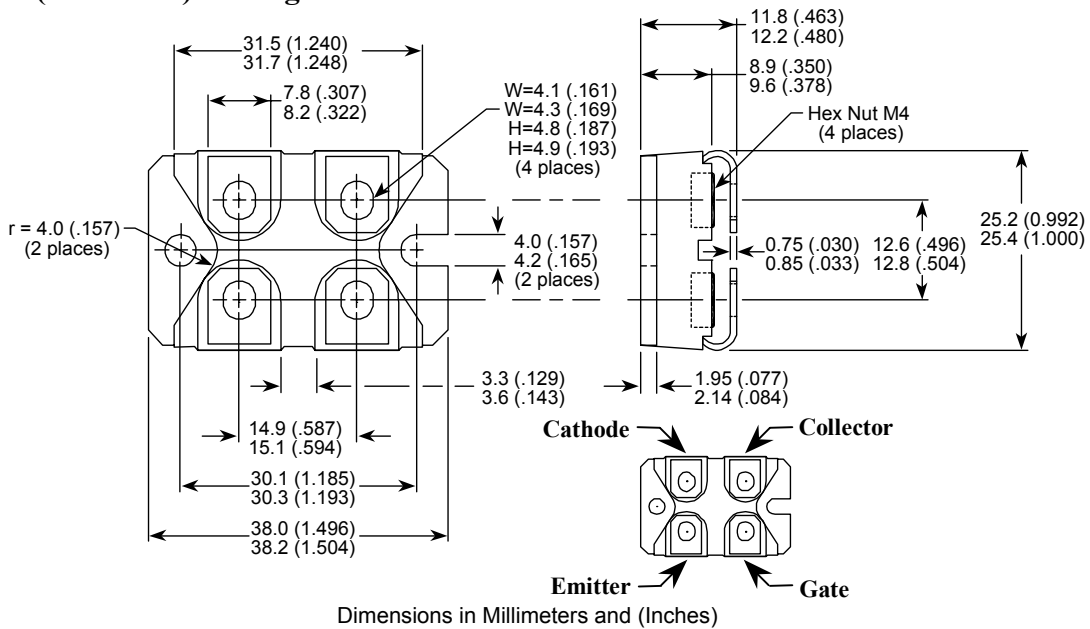

Figure 10. Diode Reverse Recovery Waveform and Definitions

SOT-227 (ISOTOP®) Package Outline



ISOTOP® is a Registered Trademark of SGS Thomson

APT reserves the right to change, without notice, the specifications and information contained herein

APT's products are covered by one or more of U.S patents 4,895,810 5,045,903 5,089,434 5,182,234 5,019,522 5,262,336 6,503,786 5,256,583 4,748,103 5,283,202 5,231,474 5,434,095 5,528,058 and foreign patents. U.S and Foreign patents pending. All Rights Reserved.