

Naos Raptor 60A: Non-Isolated Power Modules

5 – 13.8Vdc input; 0.6Vdc to 5.0Vdc Output; 60A Output Current

TUNABLE
LOOP™
A LINEAGE POWER TRADEMARK

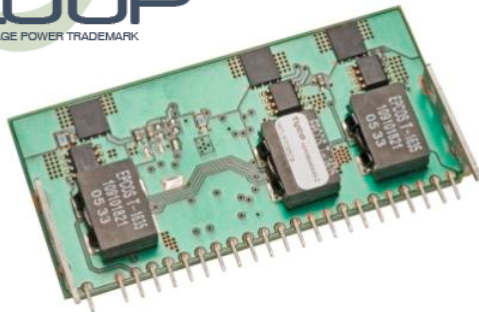

RoHS Compliant Applications

- Distributed power architectures
- Intermediate bus voltage applications
- Telecommunications equipment
- Servers and storage applications
- Networking equipment

Features

- Compliant to RoHS EU Directive 2002/95/EC (Z versions)
- Compatible in a Pb-free or SnPb wave-soldering environment (Z versions)
- Wide input voltage range (5Vdc-13.8Vdc)
- Output voltage programmable from 0.6Vdc to 5.0Vdc via external resistor
- Tunable Loop™ to optimize dynamic output voltage response
- Fixed switching frequency
- Output overcurrent protection (non-latching)
- Over temperature protection
- Over voltage protection – Hiccup Mode
- Remote On/Off
- Power Good Signal
- Small size:
 - 65.5 mm x 31.8 mm x 11.6 mm
 - (2.58 in. x 1.25 in. x 0.46 in.)
- Wide operating temperature range (0°C to 70°C)
- UL* 60950 Recognized, CSA† C22.2 No. 60950-00 Certified, and VDE‡ 0805 (EN60950-1 3rd edition) Licensed
- ISO** 9001 and ISO 14001 certified manufacturing facilities

Description

The Naos Raptor 60A SIP power modules are non-isolated dc-dc converters in an industry standard package that can deliver up to 60A of output current with a full load efficiency of 92.1% at 3.3Vdc output voltage ($V_{IN} = 12Vdc$). These modules operate over a wide range of input voltage ($V_{IN} = 5Vdc-13.8Vdc$) and provide a precisely regulated output voltage from 0.6dc to 5.0Vdc, programmable via an external resistor. Features include remote On/Off, adjustable output voltage, over current, over temperature and over voltage protection. A new feature, the Tunable Loop™, allows the user to optimize the dynamic response of the converter to match the load.

www.DataSheet4U.com

* UL is a registered trademark of Underwriters Laboratories, Inc.
† CSA is a registered trademark of Canadian Standards Association.
‡ VDE is a trademark of Verband Deutscher Elektrotechniker e.V.
** ISO is a registered trademark of the International Organization of Standards

Absolute Maximum Ratings

Stresses in excess of the absolute maximum ratings can cause permanent damage to the device. These are absolute stress ratings only, functional operation of the device is not implied at these or any other conditions in excess of those given in the operations sections of the data sheet. Exposure to absolute maximum ratings for extended periods can adversely affect the device reliability.

| Parameter | Device | Symbol | Min | Max | Unit |
|---|--------|-----------|------|-----|------|
| Input Voltage Continuous | All | V_{IN} | -0.3 | 15 | Vdc |
| Operating Ambient Temperature (see Thermal Considerations section) | All | T_A | 0 | 70 | °C |
| Storage Temperature | All | T_{stg} | -55 | 125 | °C |

Electrical Specifications

Unless otherwise indicated, specifications apply over all operating input voltage, resistive load, and temperature conditions.

| Parameter | Device | Symbol | Min | Typ | Max | Unit |
|--|------------------------|--------------------|-----|------|------|------------------|
| Operating Input Voltage | All | V_{IN} | 5 | 12.0 | 13.8 | Vdc |
| Maximum Input Current ($V_{IN} = V_{IN, min}$ to $V_{IN, max}$, $I_O = I_{O, max}$, $V_{O, set} = 3.3Vdc$) | All | $I_{IN, max}$ | | | 40 | Adc |
| Input No Load Current ($V_{IN} = 9Vdc$, $I_O = 0$, module ON) | $V_{O, set} = 0.6 Vdc$ | $I_{IN, No load}$ | | 36 | | mA |
| ($V_{IN} = 12Vdc$, $I_O = 0$, module ON) | $V_{O, set} = 5.0Vdc$ | $I_{IN, No load}$ | | 86 | | mA |
| Input Stand-by Current ($V_{IN} = 12Vdc$, module disabled) | All | $I_{IN, stand-by}$ | | 1 | | mA |
| Inrush Transient | All | I^2t | | | 1 | A ² s |
| Input Reflected Ripple Current, peak-to-peak (5Hz to 20MHz, 1μH source impedance; $V_{IN, min}$ to $V_{IN, max}$, $I_O = I_{O, max}$; See Test configuration section) | All | | | 150 | | mAp-p |
| Input Ripple Rejection (120Hz) | All | | | 50 | | dB |

Electrical Specifications (continued)

| Parameter | Device | Symbol | Min | Typ | Max | Unit |
|--|------------------------------|--------------|-------|------|-------|---------------------|
| Output Voltage Set-point ($V_{IN}=V_{IN, min}$, $I_O=I_{O, max}$, $T_A=25^\circ\text{C}$) $V_{O, SET} \geq 1.2\text{Vdc}$ $V_{O, SET} < 1.2\text{Vdc}$ | All | $V_{O, set}$ | -0.8 | — | +0.8 | % $V_{O, set}$ |
| | All | $V_{O, set}$ | -10 | — | +10 | mV |
| Output Voltage (Over all operating input voltage, resistive load, and temperature conditions until end of life) | All | $V_{O, set}$ | -1.1% | — | +1.1% | % $V_{O, set}$ |
| Adjustment Range Selected by an external resistor | All | V_O | 0.6 | — | 5.0 | Vdc |
| Output Regulation (for $V_O \geq 2.5\text{V}$) | | | | | | |
| Input range1 (5V – 9V); range2 (9V – 13.8V) | | | | | | |
| Line (Range1, range2) | All | | | — | 0.3 | % $V_{O, set}$ |
| Load ($I_O=I_{O, min}$ to $I_{O, max}$) | All | | | — | 0.6 | % $V_{O, set}$ |
| Line & Load | All | | | — | 0.8 | % $V_{O, set}$ |
| Output Regulation (for $V_O < 2.5\text{V}$) | | | | | | |
| Input range1 (5V – 9V); range2 (9V – 13.8V) | | | | | | |
| Line (Range1, range2) | All | | | — | 9 | mV |
| Load ($I_O=I_{O, min}$ to $I_{O, max}$) | All | | | — | 12 | mV |
| Line & Load | All | | | — | 15 | mV |
| Output Ripple and Noise on nominal output ($V_{IN}=V_{IN, nom}$ and $I_O=I_{O, min}$ to $I_{O, max}$, $C_{out} = 0\mu\text{F}$) | | | | | | |
| Peak-to-Peak (5Hz to 20MHz bandwidth) | $V_O = 0.6\text{V}$ | | — | | 30 | mV _{pk-pk} |
| Peak-to-Peak (5Hz to 20MHz bandwidth) | $V_O = 1\text{V}$ | | — | | 30 | mV _{pk-pk} |
| Peak-to-Peak (5Hz to 20MHz bandwidth) | $V_O = 1.5\text{V}$ | | — | | 40 | mV _{pk-pk} |
| Peak-to-Peak (5Hz to 20MHz bandwidth) | $V_O = 2.5\text{V}$ | | — | | 40 | mV _{pk-pk} |
| Peak-to-Peak (5Hz to 20MHz bandwidth) | $V_O = 3.3\text{V}$ | | — | | 60 | mV _{pk-pk} |
| Peak-to-Peak (5Hz to 20MHz bandwidth) | $V_O = 5.0\text{V}$ | | — | | 60 | mV _{pk-pk} |
| External Capacitance ¹ Without the Tunable Loop™ ESR $\geq 1\text{ m}\Omega$ | All | $C_{O, max}$ | — | — | 1000 | μF |
| With the Tunable Loop™ ESR $\geq 0.15\text{ m}\Omega$ | All | $C_{O, max}$ | 0 | — | 2000 | μF |
| ESR $\geq 10\text{ m}\Omega$ | All | $C_{O, max}$ | 0 | — | 10000 | μF |
| Output Current | All | I_O | 0 | — | 60 | Adc |
| Output Current Limit Inception (Hiccup Mode) | All | $I_{O, lim}$ | 103 | 130 | 180 | % I_O |
| Output Short-Circuit Current ($V_O \leq 250\text{mV}$) (Hiccup Mode) | All | $I_{O, s/c}$ | — | 5 | — | Adc |
| Efficiency $V_{IN} = V_{IN, nom}$, $T_A = 25^\circ\text{C}$ $I_O = I_{O, max}$, $V_O = V_{O, set}$ | $V_{O, set} = 0.6\text{Vdc}$ | η | | 74.4 | | % |
| | $V_{O, set} = 1.2\text{Vdc}$ | η | | 85.0 | | % |
| | $V_{O, set} = 1.8\text{Vdc}$ | η | | 88.6 | | % |
| | $V_{O, set} = 2.5\text{Vdc}$ | η | | 91.0 | | % |
| | $V_{O, set} = 3.3\text{Vdc}$ | η | | 92.1 | | % |
| | $V_{O, set} = 5.0\text{Vdc}$ | η | | 93.5 | | % |
| Switching Frequency | All | f_{sw} | — | 500 | — | kHz |

¹ External capacitors may require using the new Tunable Loop™ feature to ensure that the module is stable as well as getting the best transient response. See the Tunable Loop™ section for details.

General Specifications

| Parameter | Min | Typ | Max | Unit |
|---|-----|-----------|-----|---------|
| Calculated MTBF ($V_{IN}=12V$, $V_O=1.5Vdc$, $I_O=60^{\circ}$, $T_A=40^{\circ}C$) Per Telcordia Issue 2, Method I Case 3 | | 2,808,442 | | Hours |
| Weight | — | 22 (0.78) | — | g (oz.) |

Feature Specifications

Unless otherwise indicated, specifications apply over all operating input voltage, resistive load, and temperature conditions. See Feature Descriptions for additional information.

| Parameter | Device | Symbol | Min | Typ | Max | Unit |
|---|--------|-----------|------|-----|---------------|------------------|
| On/Off Signal Interface ($V_{IN}=V_{IN, min}$ to $V_{IN, max}$; open collector or equivalent, Signal referenced to GND) Logic High (On/Off pin open – Module ON) | | | | | | |
| Input High Current | All | I_{IH} | 0.5 | — | 3.3 | mA |
| Input High Voltage | All | V_{IH} | 3.5 | — | $V_{in, max}$ | V |
| Logic Low (Module OFF) | | | | | | |
| Input Low Current | All | I_{IL} | — | — | 200 | μA |
| Input Low Voltage | All | V_{IL} | -0.3 | — | 1.2 | V |
| PwGood (Power Good) Signal Interface Open Collector/Drain PwGood = High = Power Good PwGood = Low = Power Not Good Logic level low voltage, $I_{sink} = 4$ mA Logic level high voltage, $I_{source} = 2$ mA Sink Current, PwGood = low Source Current, PwGood = high | | | | | | |
| | | | 0 | | 0.4 | V |
| | | | 2.4 | | 5.25 | V |
| | | | | | 4 | mA |
| | | | | | 2 | mA |
| Turn-On Delay and Rise Times ($V_{IN}=V_{IN, nom}$, $I_O=I_{O, max}$, V_O to within $\pm 1\%$ of steady state) | | | | | | |
| Case 1: On/Off input is enabled and then input power is applied (delay from instant at which $V_{IN} = V_{IN, min}$ until $V_O = 10\%$ of $V_{O, set}$) | All | Tdelay | | | 3 | msec |
| Case 2: Input power is applied for at least one second and then the On/Off input is enabled (delay from instant at which On/Off is enabled until $V_O = 10\%$ of $V_{O, set}$) | All | Tdelay | | | 1.2 | msec |
| Output voltage Rise time (time for V_O to rise from 10% of $V_{O, set}$ to 90% of $V_{O, set}$) | All | Trise | | | 3 | msec |
| Output voltage overshoot $I_O = I_{O, max}$; $V_{IN, min} - V_{IN, max}$; $T_A = 25^{\circ}C$ | | | | | 0.5 | % $V_{O, set}$ |
| Remote Sense Range | All | | — | — | 0.5 | V |
| Over Temperature Protection (See Thermal Considerations section) | All | T_{ref} | | 135 | | $^{\circ}C$ |
| Input Undervoltage Lockout | | | | | | |
| Turn-on Threshold | All | | | 4.5 | 4.8 | Vdc |
| Turn-off Threshold | All | | | 4.1 | 4.4 | Vdc |
| Overvoltage Protection (Hiccup Mode) | All | | 120 | 125 | 130 | $V_{O, set}$, % |

Characteristic Curves

The following figures provide typical characteristics for the Naos Raptor 60A module at 0.6Vout and at 25°C.

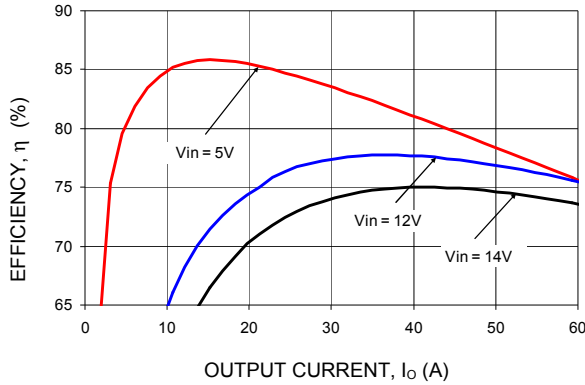

Figure 1. Converter Efficiency versus Output Current.

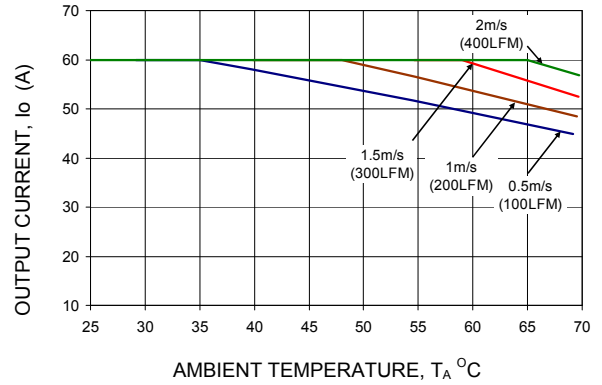

Figure 2. Derating Output Current versus Ambient Temperature and Airflow.

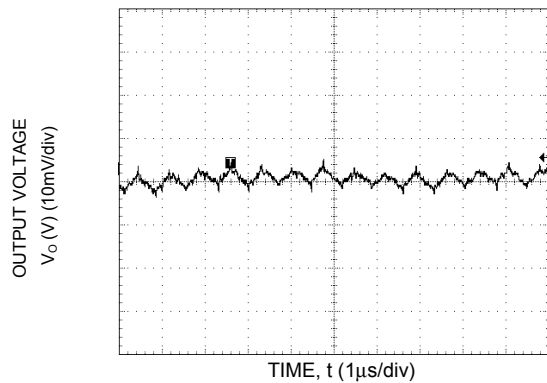

Figure 3. Typical output ripple and noise ($V_{IN} = 12V$, $I_o = I_{o,max}$).

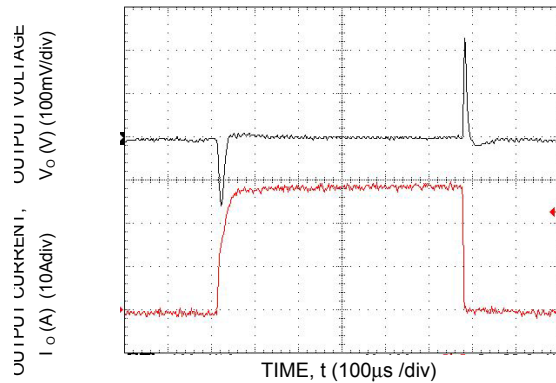

Figure 4. Transient Response to Dynamic Load Change from 0% to 50% to 0% with $V_{IN}=12V$.

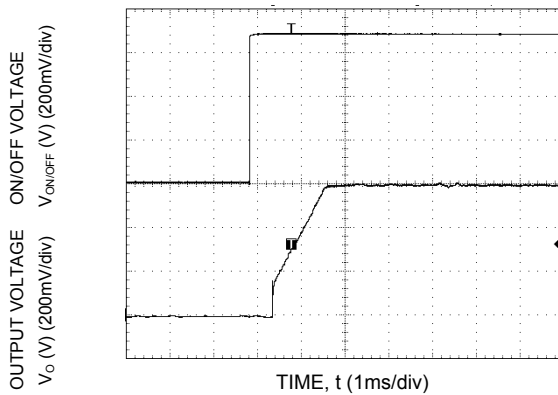

Figure 5. Typical Start-up Using On/Off Voltage ($I_o = I_{o,max}$).

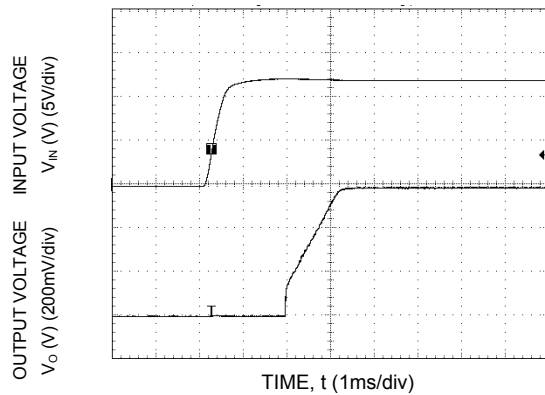

Figure 6. Typical Start-up Using Input Voltage ($V_{IN} = 12V$, $I_o = I_{o,max}$).

Characteristic Curves (continued)

The following figures provide typical characteristics for the Naos Raptor 60A module at 1.2V_{out} and at 25°C.

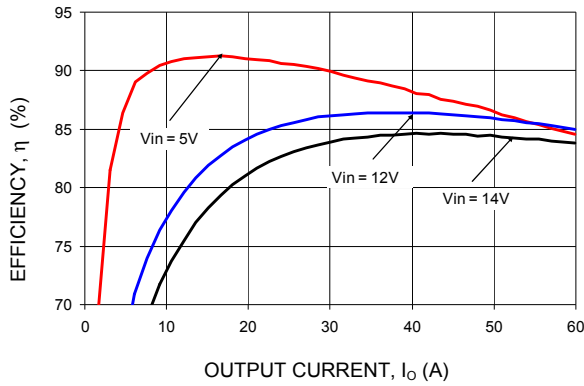

Figure 7. Converter Efficiency versus Output Current.

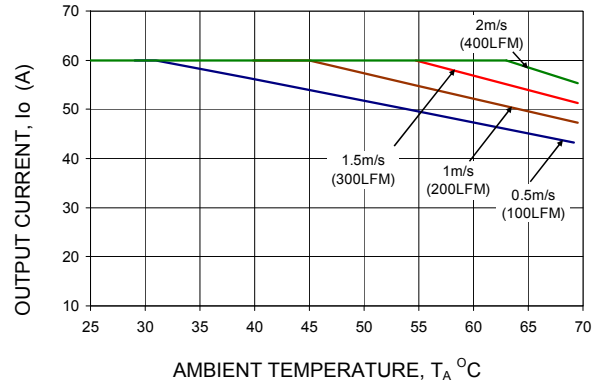

Figure 8. Derating Output Current versus Ambient Temperature and Airflow.

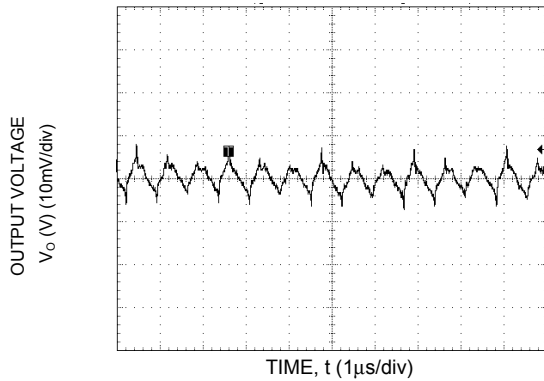

Figure 9. Typical output ripple and noise ($V_{IN} = 12V$, $I_o = I_{o,max}$).

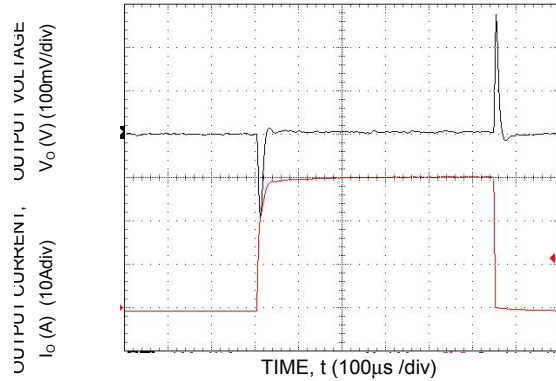

Figure 10. Transient Response to Dynamic Load Change from 0% to 50% to 0% with $V_{IN}=12V$.

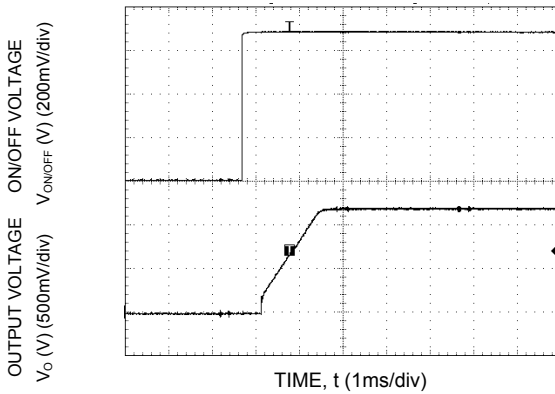

Figure 11. Typical Start-up Using On/Off Voltage ($I_o = I_{o,max}$).

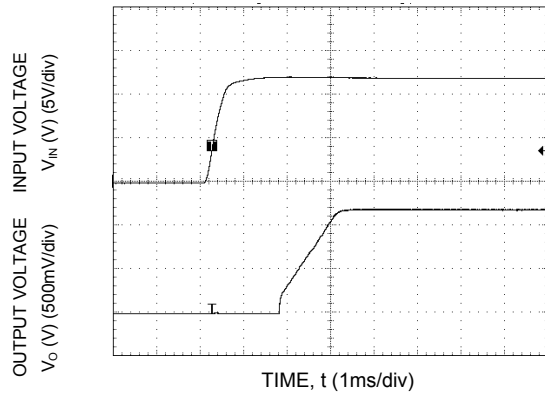

Figure 12. Typical Start-up Using Input Voltage ($V_{IN} = 12V$, $I_o = I_{o,max}$).

Characteristic Curves (continued)

The following figures provide typical characteristics for the Naos Raptor 60A module at 1.8Vout and at 25°C.

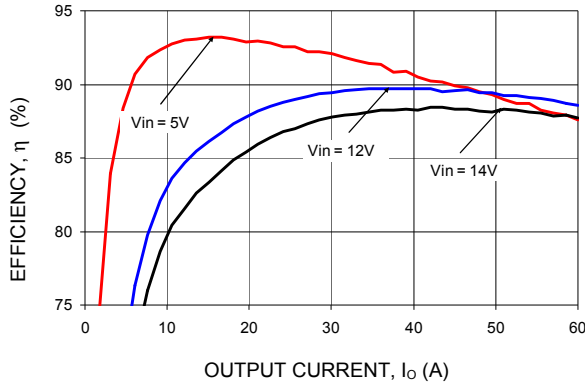

Figure 13. Converter Efficiency versus Output Current.

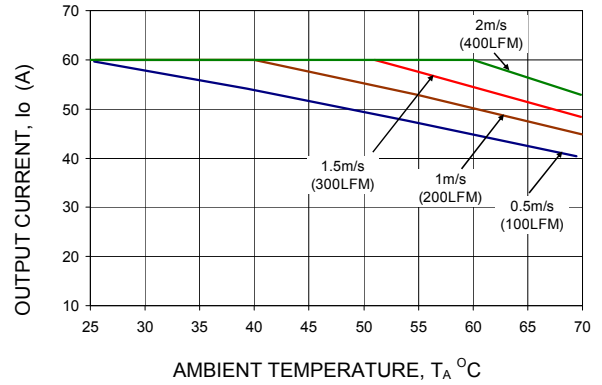

Figure 14. Derating Output Current versus Ambient Temperature and Airflow.

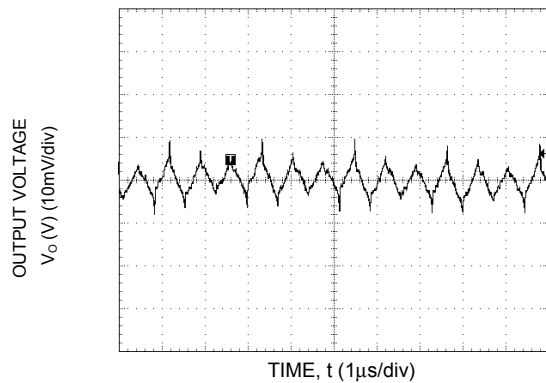

Figure 15. Typical output ripple and noise ($V_{IN} = 12V$, $I_o = I_{o,max}$).

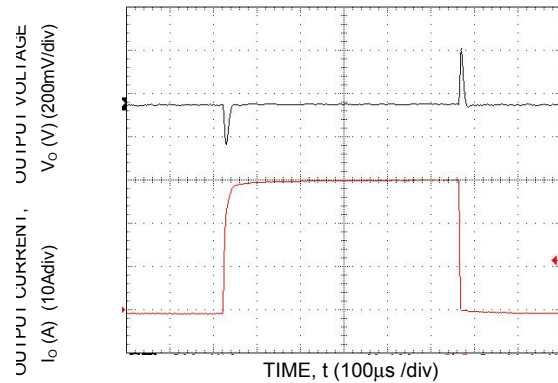

Figure 16. Transient Response to Dynamic Load Change from 0% to 50% to 0% with $V_{IN}=12V$.

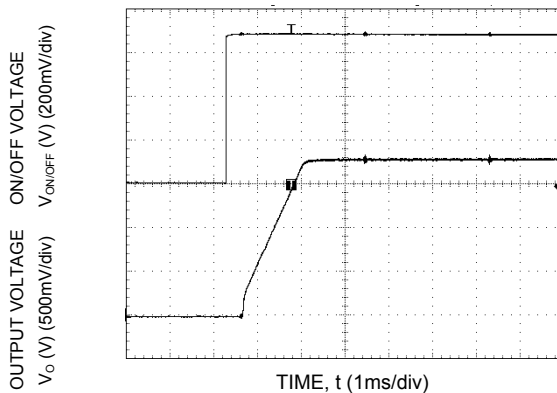

Figure 17. Typical Start-up Using On/Off Voltage ($I_o = I_{o,max}$).

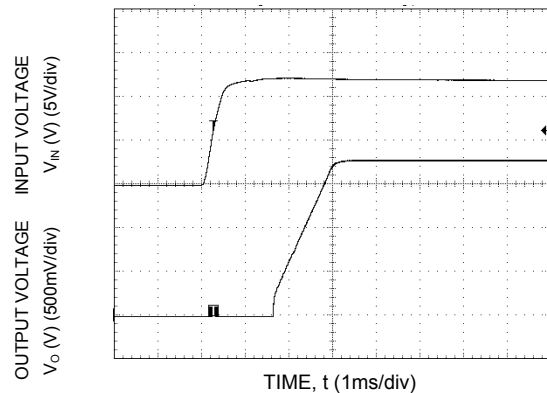

Figure 18. Typical Start-up Using Input Voltage ($V_{IN} = 12V$, $I_o = I_{o,max}$).

Characteristic Curves (continued)

The following figures provide typical characteristics for the Naos Raptor 60A module at 2.5V_{out} and at 25°C.

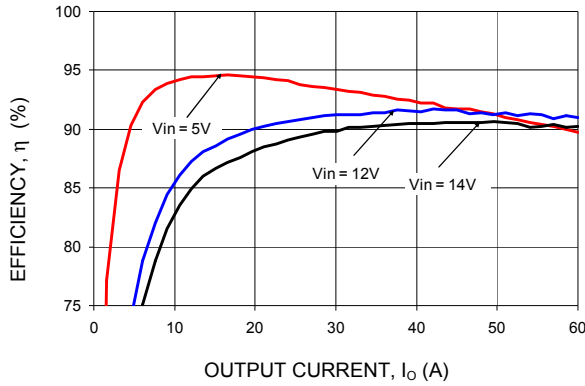

Figure 19. Converter Efficiency versus Output Current.

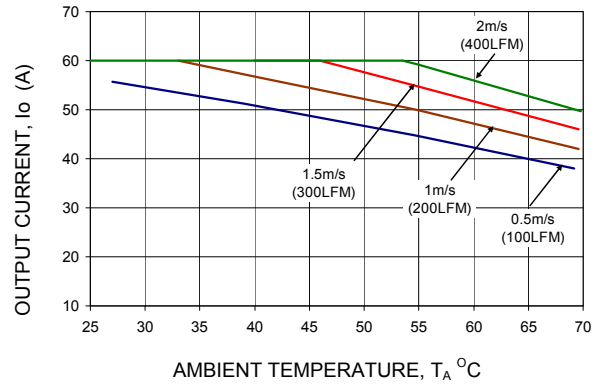

Figure 20. Derating Output Current versus Ambient Temperature and Airflow.

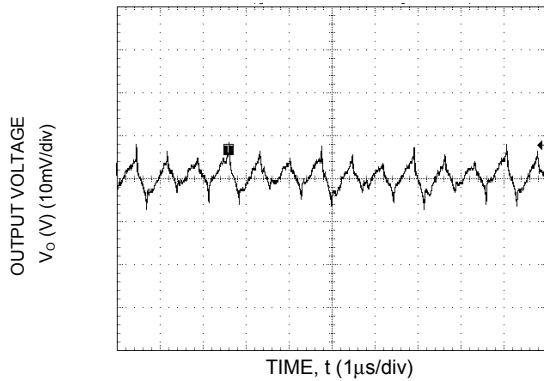

Figure 21. Typical output ripple and noise ($V_{IN} = 12V$, $I_o = I_{o,max}$).

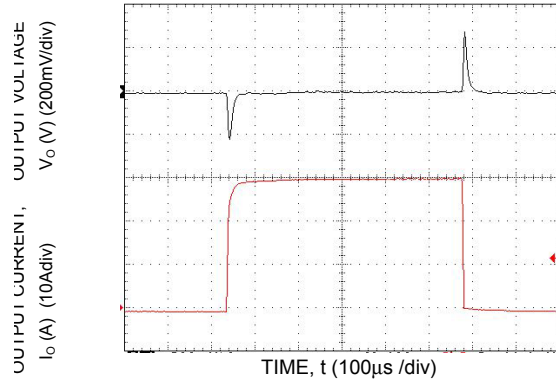

Figure 22. Transient Response to Dynamic Load Change from 0% to 50% to 0% with $V_{IN}=12V$.

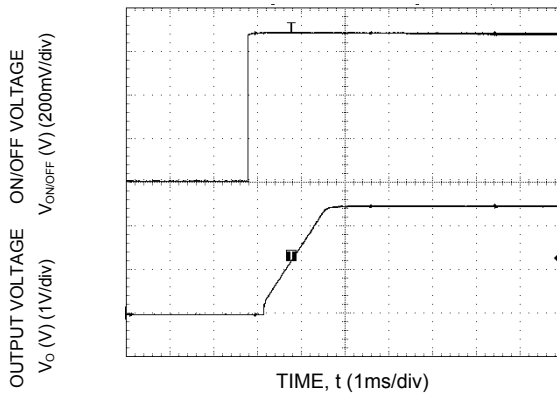

Figure 23. Typical Start-up Using On/Off Voltage ($I_o = I_{o,max}$).

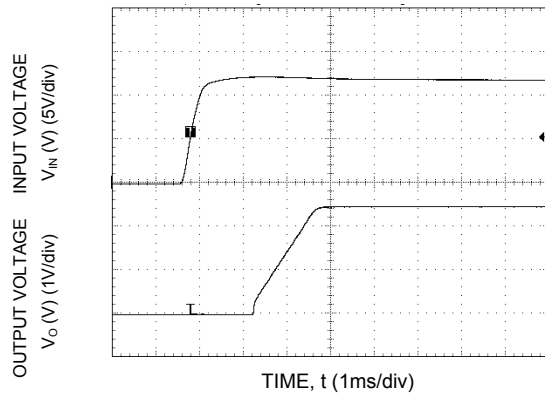

Figure 24. Typical Start-up Using Input Voltage ($V_{IN} = 12V$, $I_o = I_{o,max}$).

Characteristic Curves (continued)

The following figures provide typical characteristics for the Naos Raptor 60A module at 3.3V_{out} and at 25°C.

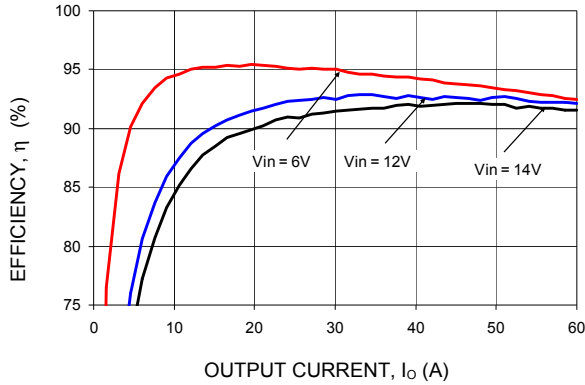

Figure 25. Converter Efficiency versus Output Current.

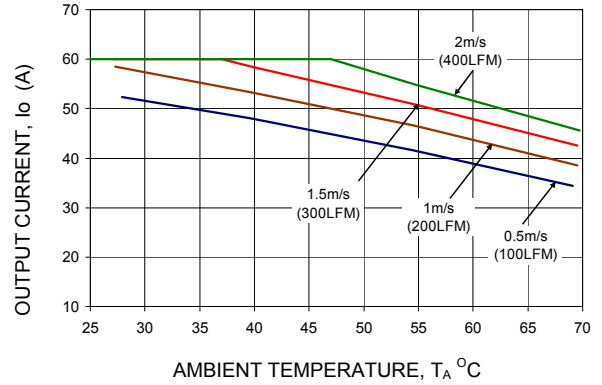

Figure 26. Derating Output Current versus Ambient Temperature and Airflow.

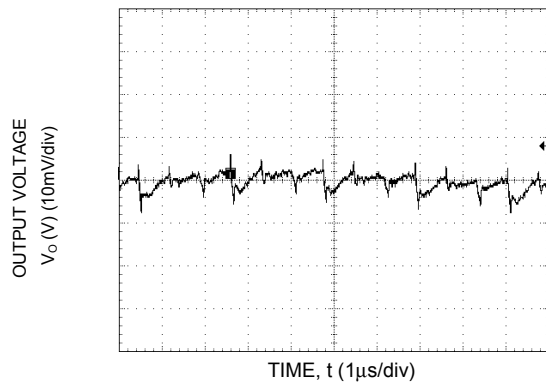

Figure 27. Typical output ripple and noise ($V_{IN} = 12V$, $I_o = I_{o,max}$).

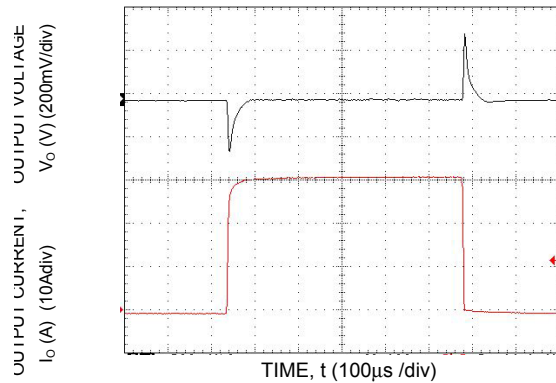

Figure 28. Transient Response to Dynamic Load Change from 0% to 50% to 0% with $V_{IN}=12V$.

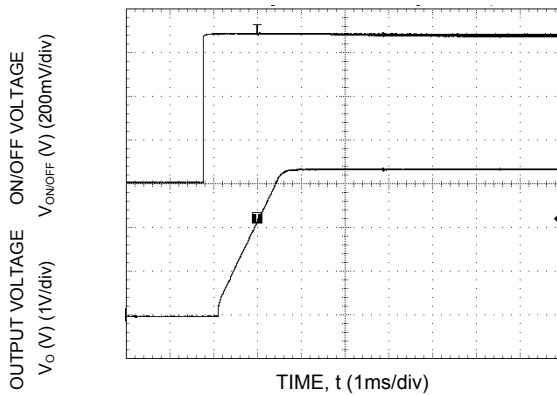

Figure 29. Typical Start-up Using On/Off Voltage ($I_o = I_{o,max}$).

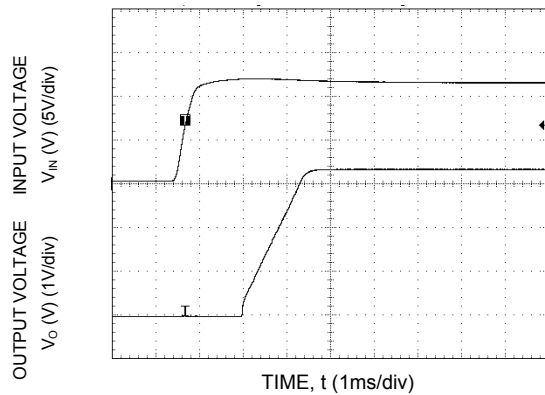

Figure 30. Typical Start-up Using Input Voltage ($V_{IN} = 12V$, $I_o = I_{o,max}$).

Characteristic Curves (continued)

The following figures provide typical characteristics for the Naos Raptor 60A module at 5V_{out} and at 25°C.

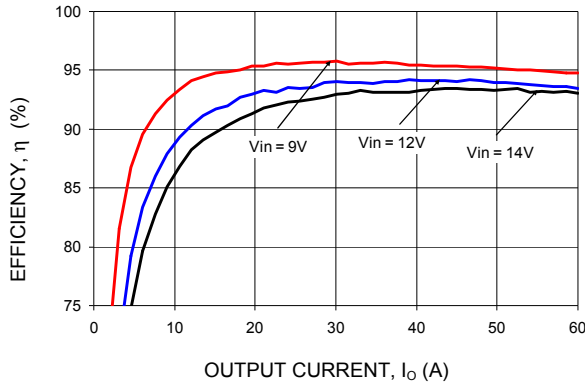

Figure 31. Converter Efficiency versus Output Current.

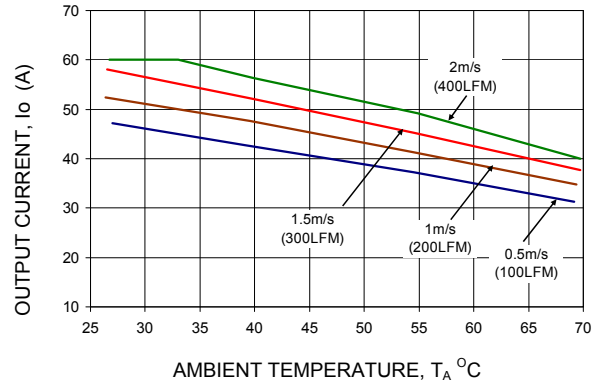

Figure 32. Derating Output Current versus Ambient Temperature and Airflow.

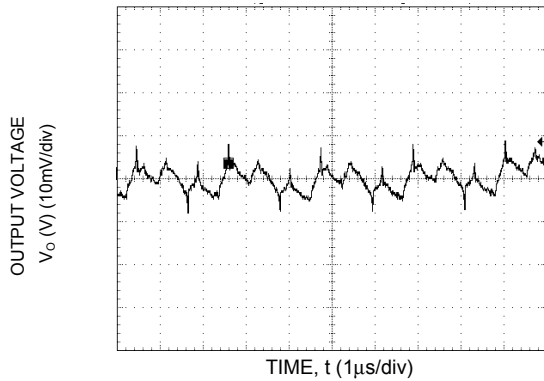

Figure 33. Typical output ripple and noise ($V_{IN} = 12V$, $I_o = I_{o,max}$).

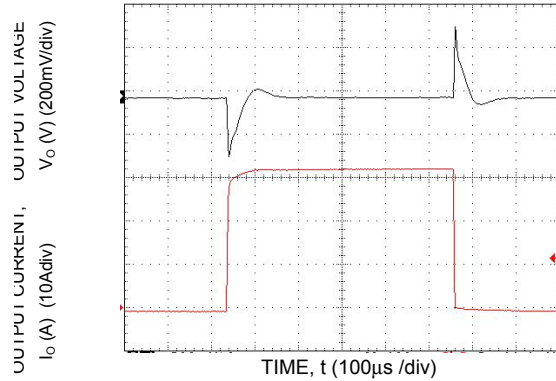

Figure 34. Transient Response to Dynamic Load Change from 0% to 50% to 0% with $V_{IN}=12V$.

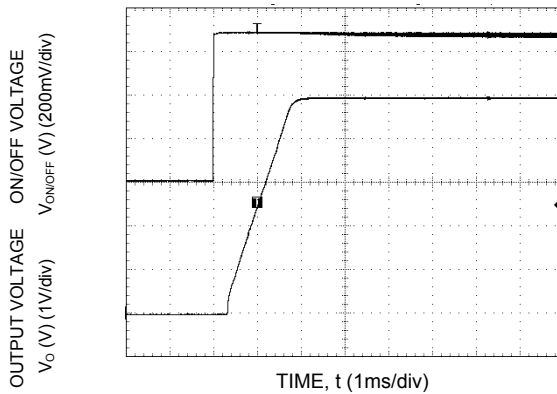

Figure 35. Typical Start-up Using On/Off Voltage ($I_o = I_{o,max}$).

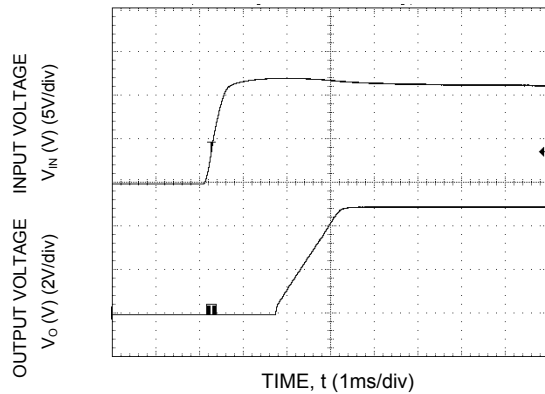
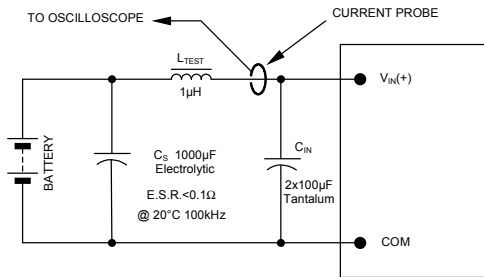

Figure 36. Typical Start-up Using Input Voltage ($V_{IN} = 12V$, $I_o = I_{o,max}$).

Test Configurations



NOTE: Measure input reflected ripple current with a simulated source inductance (L_{TEST}) of 1µH. Capacitor C_S offsets possible battery impedance. Measure current as shown above.

Figure 37. Input Reflected Ripple Current Test Setup.

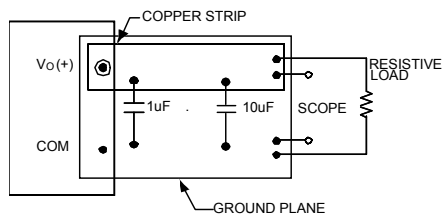

NOTE: All voltage measurements to be taken at the module terminals, as shown above. If sockets are used then Kelvin connections are required at the module terminals to avoid measurement errors due to socket contact resistance.

Figure 38. Output Ripple and Noise Test Setup.

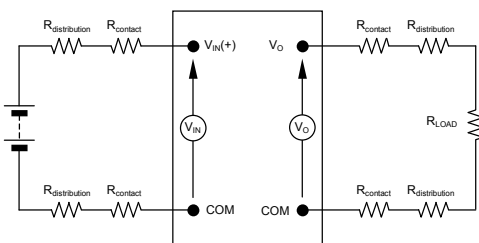

NOTE: All voltage measurements to be taken at the module terminals, as shown above. If sockets are used then Kelvin connections are required at the module terminals to avoid measurement errors due to socket contact resistance.

Figure 39. Output Voltage and Efficiency Test Setup.

$$\text{Efficiency } \eta = \frac{V_O \cdot I_O}{V_{IN} \cdot I_{IN}} \times 100 \%$$

www.DataSheet4U.com

Design Considerations

Input Filtering

The Naos Raptor 60A module should be connected to a low-impedance source. A highly inductive source can affect the stability of the module. An input capacitance must be placed directly adjacent to the input pin of the module, to minimize input ripple voltage and ensure module stability.

To minimize input voltage ripple, low-ESR polymer and ceramic capacitors are recommended at the input of the module. Figure 40 shows the input ripple voltage for various output voltages at 60A of load current with 2x22 µF or 4x22 µF ceramic capacitors and an input of 12V.

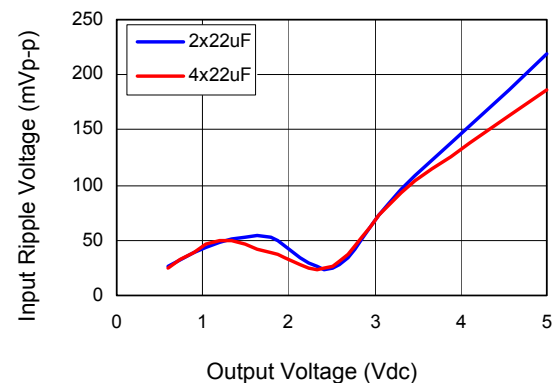

Figure 40. Input ripple voltage for various output voltages with 2x22 µF or 4x22 µF ceramic capacitors at the input (60A load). Input voltage is 12V.

Output Filtering

The Naos Raptor 60A modules are designed for low output ripple voltage and will meet the maximum output ripple specification with no external capacitors. However, additional output filtering may be required by the system designer for a number of reasons. First, there may be a need to further reduce the output ripple and noise of the module. Second, the dynamic response characteristics may need to be customized to a particular load step change.

To reduce the output ripple and improve the dynamic response to a step load change, additional capacitance at the output can be used. Low ESR ceramic and polymer are recommended to improve the dynamic response of the module. For stable operation of the module, limit the capacitance to less than the maximum output capacitance as specified in the electrical specification table. Optimal performance of the module can be achieved by using

the Tunable Loop™ feature described later in this data sheet.

Safety Considerations

For safety agency approval the power module must be installed in compliance with the spacing and separation requirements of the end-use safety agency standards, i.e., UL 60950-1, CSA C22.2 No. 60950-1-03, and VDE 0850:2001-12 (EN60950-1) Licensed.

For the converter output to be considered meeting the requirements of safety extra-low voltage (SELV), the input must meet SELV requirements. The power module has extra-low voltage (ELV) outputs when all inputs are ELV.

An input fuse for the module is recommended. Due to the wide input voltage and output voltage ranges of the module, different fuse ratings are recommended as shown in Table 1. These are suggested “maximum” fuse ratings. However, for optimum circuit protection, the fuse value should not be any larger than required in the end application. As an option to using a fuse, no fuse is required, if the module is

1. powered by a power source with current limit protection set point less than the protection device value listed in Table 1, and
2. the module is evaluated in the end-use equipment.

Table 1.

| Input Voltage (VDC) | Output Voltage (VDC) | | |
|---------------------|----------------------|-------------|-------------|
| | 0.59 to 1.3 | 1.31 to 2.7 | 2.71 to 5.0 |
| 10.1 to 14 | 25A | 50A | 80A |
| 6.51 to 10 | 40A | 70A | 100A |
| 5 to 6.5 | 40A | 90A | 100A |

Feature Descriptions

Remote On/Off

The Naos Raptor 60A power modules feature a remote On/Off pin with positive logic. If not using the On/Off pin, leave the pin open (the module will be ON, except for the -49 option modules where leaving the pin open will cause the module to remain OFF). The On/Off signal ($V_{On/Off}$) is referenced to ground.

During a Logic High on the On/Off pin, the module remains ON. During Logic-Low, the module is turned OFF.

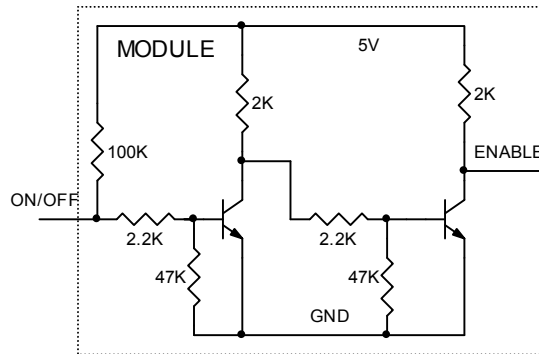

Figure 41. Remote On/Off Implementation. The 100K resistor is absent in the -49 option modules.

Overcurrent Protection

To provide protection in a fault (output overload) condition, the unit is equipped with internal current-limiting circuitry and can endure current limiting continuously. At the point of current-limit inception, the unit enters hiccup mode. The unit operates normally once the output current is brought back into its specified range. The typical average output current during hiccup is 10% of $I_{o,max}$.

Over Temperature Protection

To provide protection in a fault condition, the unit is equipped with a thermal shutdown circuit. The unit will shut down if the overtemperature threshold of 135°C is exceeded at the thermal reference point T_{red} . The thermal shutdown is not intended as a guarantee that the unit will survive temperatures beyond its rating. Once the unit goes into thermal shutdown, it will then wait to cool before attempting to restart.

Input Undervoltage Lockout

At input voltages below the input undervoltage lockout limit, module operation is disabled. The module will begin to operate at an input voltage above the undervoltage lockout turn-on threshold.

Power Good

The Naos Raptor 60A power modules provide a Power Good Status signal that indicates whether or not the power module is functioning properly.

PwGood is a power good signal implemented with an open-collector output to indicate that the output voltage is within the regulation limits of the power module. The PwGood signal will be de-asserted to a low state if any condition such as over-temperature, over-current, or over-voltage occurs which would result in the output voltage going out of range.

Output Voltage Programming

The output voltage of the Naos Raptor 60A module can be programmed to any voltage from 0.6Vdc to 5.0Vdc by connecting a resistor between the Trim + and Trim - pins of the module. Without an external resistor between Trim + and Trim - pins, the output of the module will be 0.6Vdc. To calculate the value of the trim resistor, R_{trim} for a desired output voltage, use the following equation:

$$R_{trim} = \frac{1.2}{(V_o - 0.6)} k\Omega$$

R_{trim} is the external resistor in $k\Omega$

V_o is the desired output voltage

Table 2 provides R_{trim} values required for some common output voltages.

By using a $\pm 0.1\%$ tolerance trim resistor with a TC of ± 25 ppm, a set point tolerance of $\pm 0.8\%$ can be achieved as specified in the electrical specification. The POL Programming Tool available at www.lineagepower.com under the Design Tools section, helps determine the required trim resistor needed for a specific output voltage.

Note: $V_{in} \geq 180\%$ of V_{out} at the module output pin.

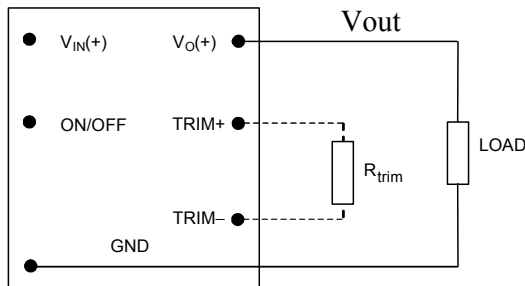

Figure 42. Circuit configuration for programming output voltage using an external resistor.

Table 2

| $V_{o, set}$ (V) | R_{trim} (Ω) |
|------------------|-------------------------|
| 0.6 | Open |
| 1.0 | 3000 |
| 1.2 | 2000 |
| 1.5 | 1333 |
| 1.8 | 1000 |
| 2.5 | 632 |
| 3.3 | 444 |
| 5.0 | 273 |

Monotonic Start-up and Shutdown

The Naos Raptor 60A modules have monotonic start-up and shutdown behavior for any combination of rated input voltage, output current and operating temperature range.

Feature Descriptions (continued)

Tunable Loop™

The Naos Raptor 60A modules have a new feature that optimizes transient response of the module called Tunable Loop™. External capacitors are usually added to improve output voltage transient response due to load current changes. Sensitive loads may also require additional output capacitance to reduce output ripple and noise. Adding external capacitance however affects the voltage control loop of the module, typically causing the loop to slow down with sluggish response. Larger values of external capacitance could also cause the module to become unstable.

To use the additional external capacitors in an optimal manner, the Tunable Loop™ feature allows the loop to be tuned externally by connecting a series R-C between the SENSE and TRIM pins of the module, as shown in Fig. 43. This R-C allows the user to externally adjust the voltage loop feedback compensation of the module to match the filter network connected to the output of the module.

Recommended values of R_{TUNE} and C_{TUNE} are given in Tables 3 and 4. Table 3 lists recommended values of R_{TUNE} and C_{TUNE} in order to meet 2% output voltage deviation limits for some common output voltages in the presence of a 30A to 60A step change (50% of full load), with an input voltage of 12V. Table 4 shows the recommended values of R_{TUNE} and C_{TUNE} for different values of ceramic output capacitors up to 1880 μF , again for an input voltage of 12V. The value of R_{TUNE} should never be lower than the values shown in Tables 3 and 4. Please contact your Lineage Power technical representative to obtain more details of this feature as well as for guidelines on how to select the right value of external R-C to tune the module for best transient performance and stable operation for other output capacitance values.

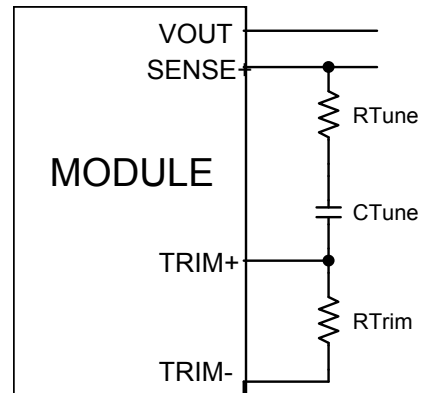

Figure 43. Circuit diagram showing connection of R_{TUNE} and C_{TUNE} to tune the control loop of the module.

Table 3. Recommended values of R_{TUNE} and C_{TUNE} to obtain transient deviation of 2% of V_{out} for a 30A step load with $V_{in}=12\text{V}$.

| Vout | 5V | 3.3V | 2.5V | 1.8V | 1.2V | 0.6V |
|------------------------------|---|---|---|--------------------------------|---------------------------------|---------------------------------|
| Cext | 2x47 μF + 2x330 μF Polymer | 6x47 μF + 3x330 μF Polymer | 2x47 μF + 5x330 μF Polymer | 8x330 μF Polymer | 13x330 μF Polymer | 31x330 μF Polymer |
| R_{TUNE} | 100 | 68 | 47 | 39 | 33 | 30 |
| C_{TUNE} | 12nF | 27nF | 47nF | 100nF | 180nF | 180nF |
| ΔV | 100mV | 66mV | 50mV | 36mV | 24mV | 12mV |

Table 4. General recommended values of R_{TUNE} and C_{TUNE} for $V_{in}=12\text{V}$ and various external ceramic capacitor combinations.

| Cext | 2x47 μF | 4x47 μF | 10x47 μF | 20x47 μF | 40x47 μF |
|------------------------------|--------------------|--------------------|---------------------|---------------------|---------------------|
| R_{TUNE} | 100 | 75 | 47 | 33 | 30 |
| C_{TUNE} | 2700pF | 4700pF | 12nF | 22nF | 27nF |

Thermal Considerations

Power modules operate in a variety of thermal environments; however sufficient cooling should always be provided to help ensure reliable operation.

Considerations include ambient temperature, airflow, module power dissipation, and the need for increased reliability. A reduction in the operating temperature of the module will result in an increase in reliability. The thermal data presented here is based on physical measurements taken in a wind tunnel. The test set-up is shown in Figure 44. The derating data applies to airflow in either direction of the module's axis.

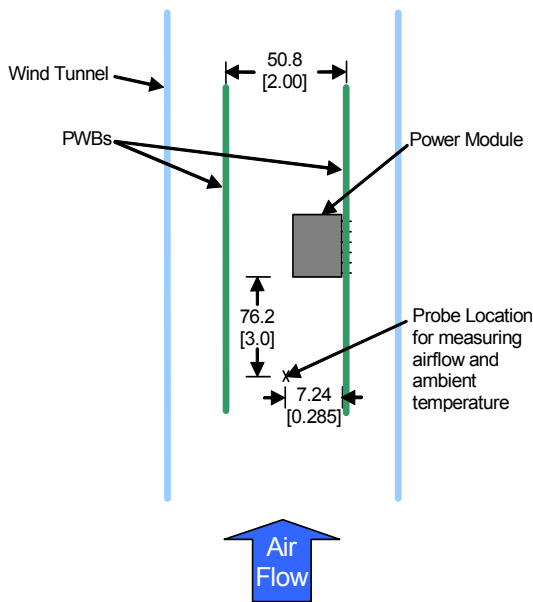

Figure 44. Thermal Test Set-up.

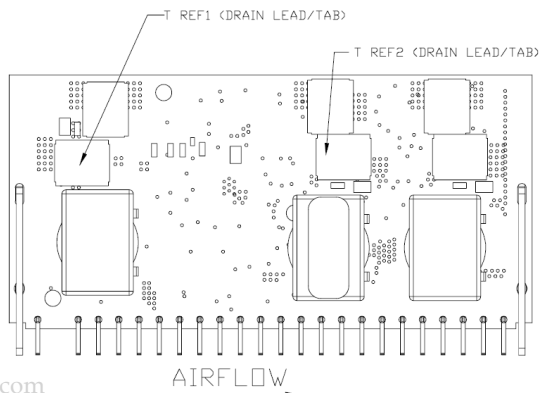

Figure 45. Temperature measurement locations T_{ref1} and T_{ref2} .

The thermal reference points, T_{ref1} and T_{ref2} used in the specifications are shown in Figure 45. For reliable operation this temperatures should not exceed 120°C.

The output power of the module should not exceed the rated power of the module ($V_{o,set} \times I_{o,max}$).

Please refer to the Application Note “Thermal Characterization Process For Open-Frame Board-Mounted Power Modules” for a detailed discussion of thermal aspects including maximum device temperatures.

Heat Transfer via Convection

Increased airflow over the module enhances the heat transfer via convection. Thermal derating curves showing the maximum output current that can be delivered at different local ambient temperatures (T_A) for airflow conditions ranging from natural convection and up to 2m/s (400 ft./min) are shown in the Characteristics Curves section.

Post solder Cleaning and Drying Considerations

Post solder cleaning is usually the final circuit-board assembly process prior to electrical board testing. The result of inadequate cleaning and drying can affect both the reliability of a power module and the testability of the finished circuit-board assembly. For guidance on appropriate soldering, cleaning and drying procedures, refer to the *Board Mounted Power Modules: Soldering and Cleaning* Application Note.

Through-Hole Lead-Free Soldering Information

The RoHS-compliant through-hole products use the SAC (Sn/Ag/Cu) Pb-free solder and RoHS-compliant components. They are designed to be processed through single or dual wave soldering machines. The pins have an RoHS-compliant finish that is compatible with both Pb and Pb-free wave soldering processes. A maximum preheat rate of 3°C/s is suggested. The wave preheat process should be such that the temperature of the power module board is kept below 210°C. For Pb solder, the recommended pot temperature is 260°C, while the Pb-free solder pot is 270°C max. Not all RoHS-compliant through-hole products can be processed with paste-through-hole Pb or Pb-free reflow process. If additional information is needed, please consult with your Lineage Power representative for more details.

Mechanical Outline

Dimensions are in millimeters and (inches).

Tolerances: x.x mm ± 0.5 mm (x.xx in. ± 0.02 in.) [unless otherwise indicated]

x.xx mm ± 0.25 mm (x.xxx in ± 0.010 in.)

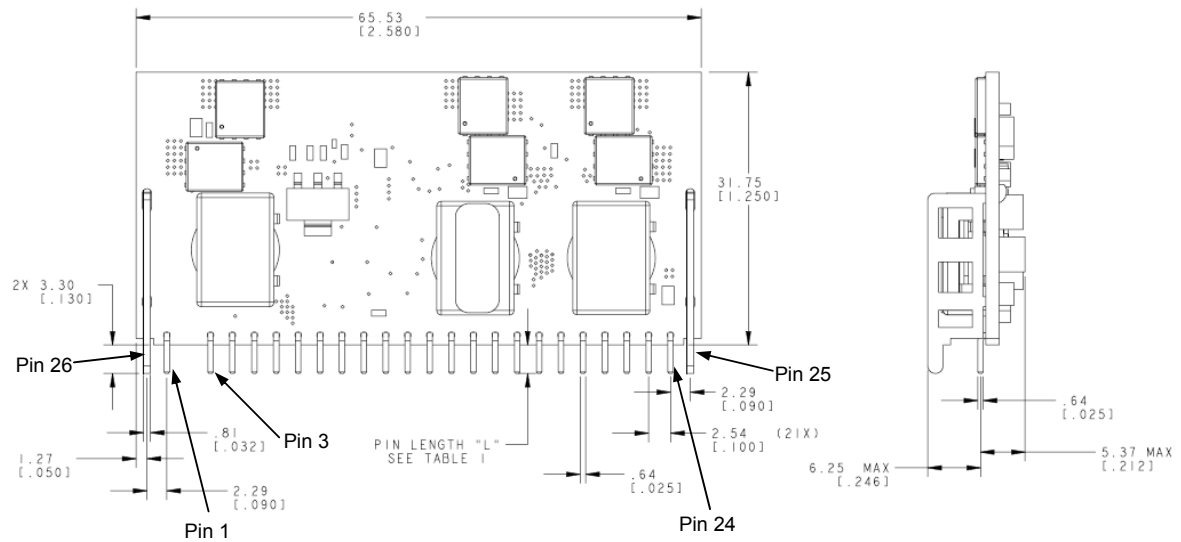

L = 2.85 ± 0.25 [0.112 ± 0.01]
L = 5.08 ± 0.25 [0.200 ± 0.01] 5 Option

Front View

Side View

Pinout

| Pin | Function | Pin | Function | Pin | Function |
|-----|----------|-----|------------------|-----|------------------|
| 1 | Trim + | 9 | On/Off | 18 | V _{out} |
| 2 | No Pin | 10 | Sense - | 19 | GND |
| 3 | GND | 11 | Sense + | 20 | V _{out} |
| 4 | PwGood | 12 | V _{in} | 21 | GND |
| 5 | Trim - | 13 | V _{in} | 22 | V _{out} |
| 6 | Ishare | 14 | V _{in} | 23 | GND |
| 7 | GND | 15 | V _{out} | 24 | V _{out} |
| 8 | GND | 16 | V _{out} | 25 | GND |
| | | 17 | GND | 26 | GND |

Recommended Pad Layout

Dimensions are in millimeters and (inches).

Tolerances: x.x mm ± 0.5 mm (x.xx in. ± 0.02 in.) [unless otherwise indicated]

x.xx mm ± 0.25 mm (x.xxx in ± 0.010 in.)

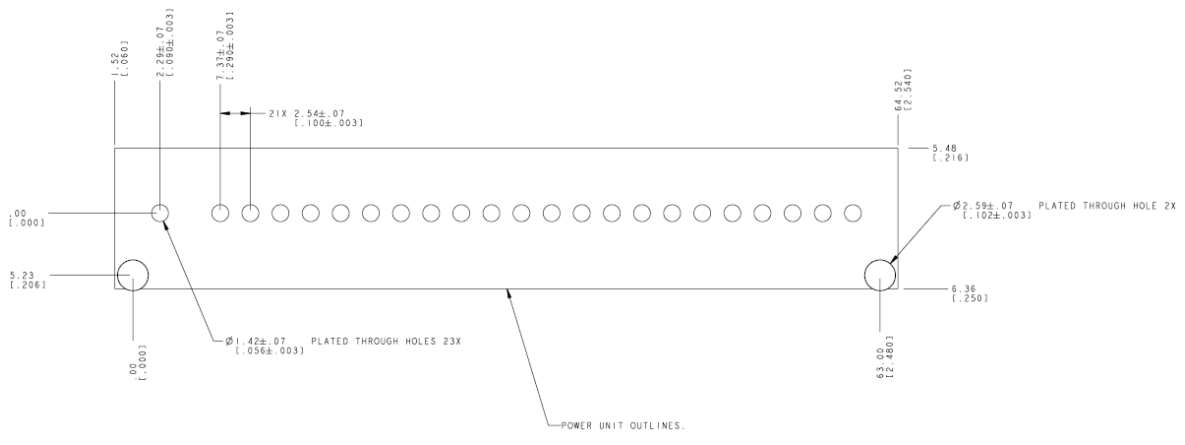

Ordering Information

Please contact your Lineage Power Sales Representative for pricing, availability and optional features.

Table 5. Device Codes

| Device Code | Input Voltage Range | Output Voltage | Output Current | On/Off Logic | Connector Type | Comcode |
|-------------------|---------------------|----------------|----------------|--------------|----------------|-------------|
| NSR060A0X43Z | 5 – 13.8Vdc | 0.6 – 5.0Vdc | 60 A | Positive | SIP | CC109130936 |
| NSR060A0X43-49Z* | 5 – 13.8Vdc | 0.6 – 5.0Vdc | 60 A | Positive | SIP | CC109138236 |
| NSR060A0X543-37Z* | 5 – 13.8Vdc | 0.6 – 5.0Vdc | 60 A | Positive | SIP | CC109150942 |

Z refers to RoHS-compliant versions.

* **Special codes, consult factory before ordering**

Table 6. Device Options

| Option | Suffix |
|---|--------|
| Long Pins 5.08 mm ± 0.25 mm [0.2 ± 0.010 in.] | 5 |



LINEAGE POWER[®]

World Wide Headquarters
Lineage Power Corporation
601 Shiloh Road, Plano, TX 75074, USA
+1-888-LINEAGE(546-3243)
(Outside U.S.A.: **+1-972-244-WATT(9288)**)
www.lineagepower.com
e-mail: techsupport1@lineagepower.com

Asia-Pacific Headquarters
Tel: +86.021.54279977*808

Europe, Middle-East and Africa Headquarters
Tel: +49.89.878067-280

India Headquarters
Tel: +91.80.28411633

Lineage Power reserves the right to make changes to the product(s) or information contained herein without notice. No liability is assumed as a result of their use or application. No rights under any patent accompany the sale of any such product(s) or information.

Lineage Power DC-DC products are protected under various patents. Information on these patents is available at www.lineagepower.com/patents.

© 2010 Lineage Power Corporation, (Plano, Texas) All International Rights Reserved.