

## Low Current SMD LED PLCC-2

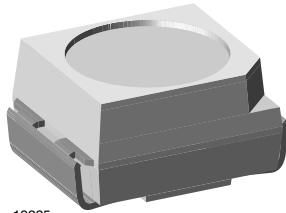

19225

### DESCRIPTION

These new devices have been designed to meet the increasing demand for low current SMD LEDs.

The package of the VLMA3100 is the PLCC-2 (equivalent to a size B tantalum capacitor).

It consists of a lead frame which is embedded in a white thermoplast. The reflector inside this package is filled up with clear epoxy.

### PRODUCT GROUP AND PACKAGE DATA

- Product group: LED
- Package: SMD PLCC-2
- Product series: Low Current
- Angle of half intensity:  $\pm 60$

### FEATURES

- SMD LED with exceptional brightness
- Compatible with automatic placement equipment
- EIA and ICE standard package
- Compatible with infrared, vapor phase and wave solder processes according to CECC
- Available in 8 mm tape
- Low profile package
- Non-diffused lens: excellent for coupling to light pipes and backlighting
- Very low power consumption
- Luminous intensity ratio in one packaging unit  $I_{Vmax}/I_{Vmin} \leq 2.0$
- Lead (Pb)-free device
- Component in accordance to RoHS 2002/95/EC and WEEE 2002/96/EC
- Automotive qualified AEC-Q101



### APPLICATIONS

Automotive: Backlighting in dashboards and switches

- Telecommunication: Indicator and backlighting in telephone and fax
- Indicator and backlight for audio and video equipment
- Indicator and backlight for battery driven equipment
- Small indicator for outdoor applications
- Indicator and backlight in office equipment
- Flat backlight for LCDs, switches and symbols
- General use

### PARTS TABLE

PART	COLOR, LUMINOUS INTENSITY	TECHNOLOGY
VLMA3100-GS08	Yellow, $I_V \geq 0.28$ mcd	GaAsP on GaP
VLMA3100-GS18	Yellow, $I_V \geq 0.28$ mcd	GaAsP on GaP



ABSOLUTE MAXIMUM RATINGS <sup>1)</sup> VLMA3100				
PARAMETER	TEST CONDITION	SYMBOL	VALUE	UNIT
Reverse voltage <sup>2)</sup>		$V_R$	6	V
DC Forward current		$I_F$	7	mA
Surge forward current	$t_p \leq 10 \mu s$	$I_{FSM}$	0.5	A
Power dissipation		$P_V$	20	mW
Junction temperature		$T_j$	100	°C
Operating temperature range		$T_{amb}$	- 40 to + 100	°C
Storage temperature range		$T_{stg}$	- 40 to + 100	°C
Soldering temperature	$t \leq 5 s$	$T_{sd}$	260	°C
Thermal resistance junction/ambient	mounted on PC board (pad size > 16 mm <sup>2</sup> )	$R_{thJA}$	500	K/W

Note:

1)  $T_{amb} = 25 \text{ }^\circ\text{C}$ , unless otherwise specified

2) Driving the LED in reverse direction is suitable for short term application

OPTICAL AND ELECTRICAL CHARACTERISTICS <sup>1)</sup> VLMA3100, YELLOW						
PARAMETER	TEST CONDITION	SYMBOL	MIN	TYP.	MAX	UNIT
Luminous intensity <sup>2)</sup>	$I_F = 2 \text{ mA}$	$I_V$	0.28	2.5		mcd
Dominant wavelength	$I_F = 2 \text{ mA}$	$\lambda_d$	581		594	nm
Peak wavelength	$I_F = 2 \text{ mA}$	$\lambda_p$		585		nm
Angle of half intensity	$I_F = 2 \text{ mA}$	$\varphi$		$\pm 60$		deg
Forward voltage	$I_F = 2 \text{ mA}$	$V_F$		2.2	2.9	V
Reverse voltage	$I_R = 10 \mu\text{A}$	$V_R$	6	20		V
Junction capacitance	$V_R = 0, f = 1 \text{ MHz}$	$C_j$		50		pF

Note:

1)  $T_{amb} = 25 \text{ }^\circ\text{C}$ , unless otherwise specified

2) In one Packing Unit  $I_{Vmax}/I_{Vmin} \leq 2.0$

LUMINOUS INTENSITY CLASSIFICATION		
GROUP	LUMINOUS INTENSITY (MCD)	
	MIN.	MAX.
C1	0.28	0.36
C2	0.36	0.45
D1	0.45	0.56
D2	0.56	0.71
E1	0.71	0.90

Note:

Luminous intensity is tested at a current pulse duration of 25 ms and an accuracy of  $\pm 11 \%$ .

The above Type Numbers represent the order groups which include only a few brightness groups. Only one group will be shipped on each reel (there will be no mixing of two groups on each reel). In order to ensure availability, single brightness groups will not be orderable.

In a similar manner for colors where wavelength groups are measured and binned, single wavelength groups will be shipped on any one reel.

In order to ensure availability, single wavelength groups will not be orderable.

COLOR CLASSIFICATION		
GROUP	DOMINANT WAVELENGTH (NM)	
	YELLOW	
	MIN.	MAX.
1	581	584
2	583	586
3	585	588
4	587	590
5	589	592
6	591	594

Note:

Wavelengths are tested at a current pulse duration of 25 ms and an accuracy of  $\pm 1 \text{ nm}$ .

**TYPICAL CHARACTERISTICS**

$T_{amb} = 25\text{ }^{\circ}\text{C}$ , unless otherwise specified

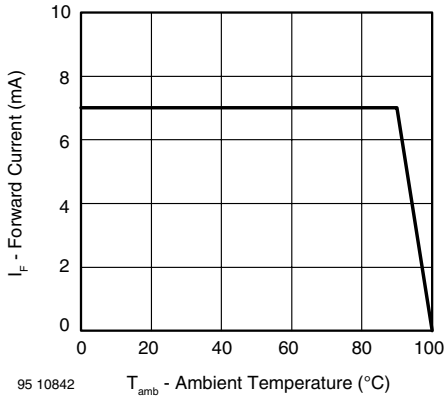
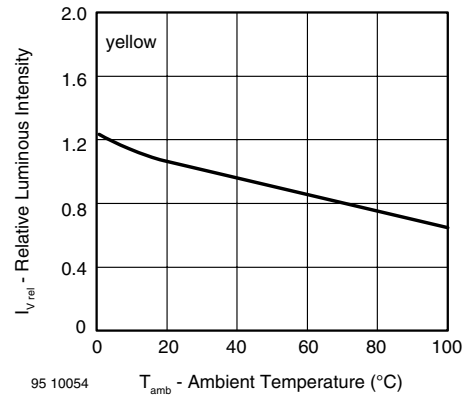

Figure 1. Forward Current vs. Ambient Temperature



Rel. Luminous Intensity vs. Ambient Temperature

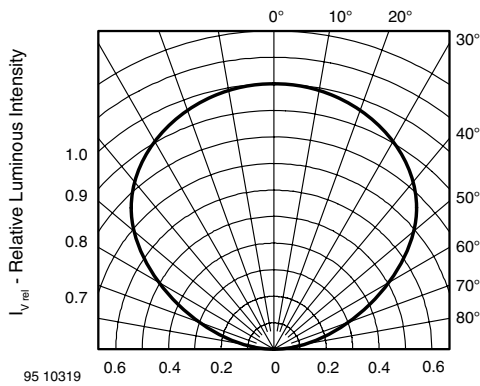

Figure 2. Rel. Luminous Intensity vs. Angular Displacement

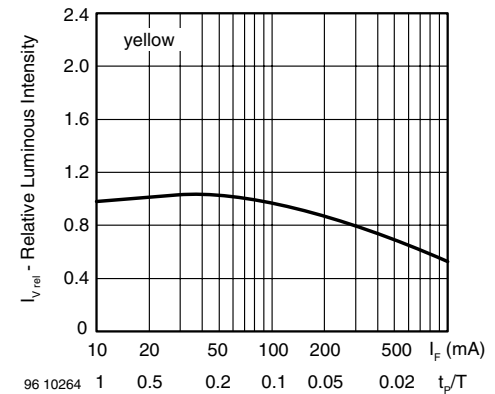

Figure 4. Rel. Lumin. Intensity vs. Forw. Current/Duty Cycle

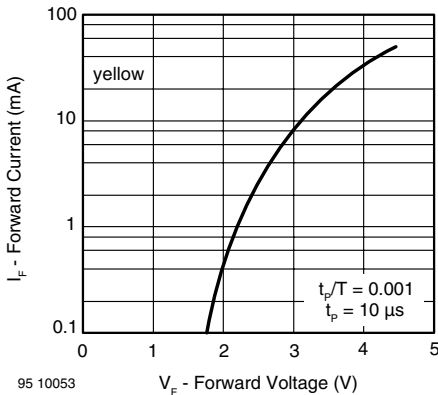

Figure 3. Forward Current vs. Forward Voltage

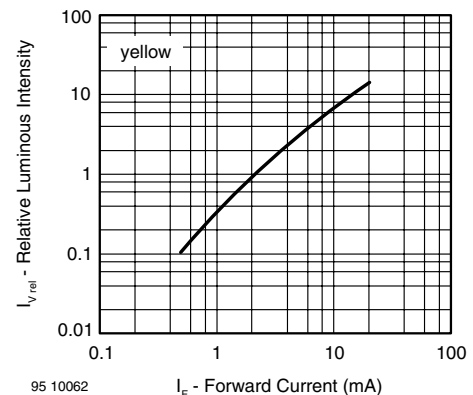

Figure 5. Relative Luminous Intensity vs. Forward Current

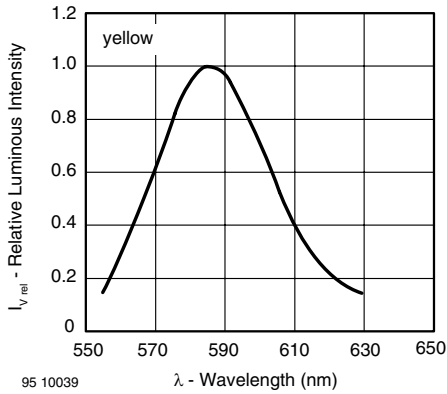
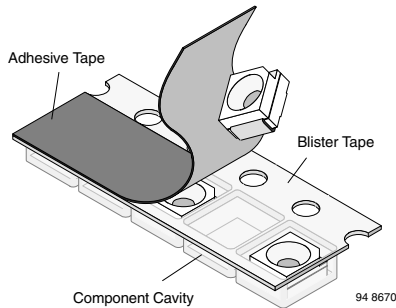

Figure 6. Relative Intensity vs. Wavelength

**METHOD OF TAPING/POLARITY AND TAPE AND REEL**

**SMD LED (VLM.3 - SERIES)**

Vishay’s LEDs in SMD packages are available in an antistatic 8 mm blister tape (in accordance with DIN IEC 40 (CO) 564) for automatic component insertion. The blister tape is a plastic strip with impressed component cavities, covered by a top tape.



**REEL PACKAGE DIMENSION IN MM FOR SMD LEDs, TAPE OPTION GS08 (= 1500 PCS.)**

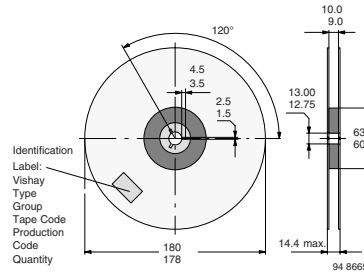

Figure 8. Reel dimensions - GS08

**TAPING OF VLM.3...**

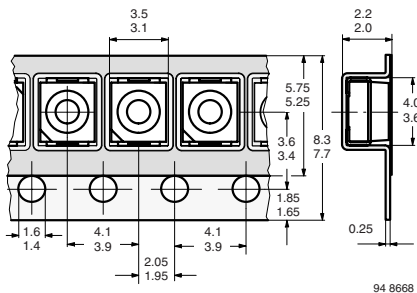

Figure 7. Tape dimensions in mm for PLCC-2

**REEL PACKAGE DIMENSION IN MM FOR SMD LEDs, TAPE OPTION GS18 (= 8000 PCS.) PREFERRED**

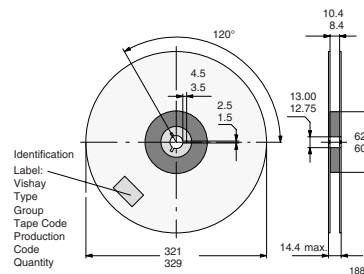

Figure 9. Reel dimensions - GS18

## SOLDERING PROFILE

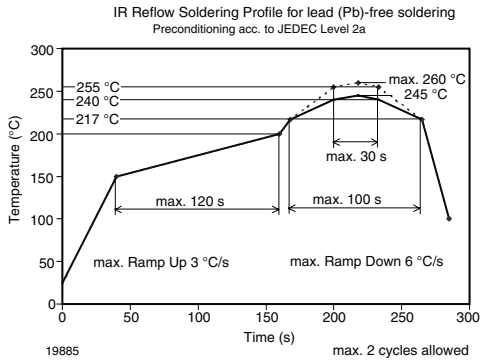

Figure 10. Vishay Lead (Pb)-free Reflow Soldering Profile (acc. to J-STD-020C)

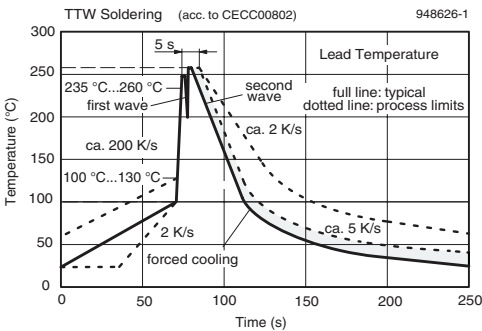
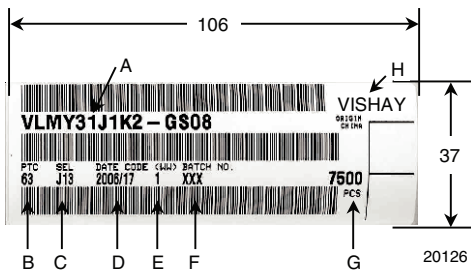

Figure 11. Double wave soldering of opto devices (all packages)

## BARCODE-PRODUCT-LABEL

### EXAMPLE:



- A) Type of component
- B) Manufacturing plant
- C) SEL - Selection Code (Bin):  
e.g.: J1 = Code for Luminous Intensity Group  
3 = Code for Color Group
- D) Date Code year/week
- E) Day Code (e.g. 1: Monday)
- F) Batch No.
- G) Total quantity
- H) Company code

## DRY PACKING

The reel is packed in an anti-humidity bag to protect the devices from absorbing moisture during transportation and storage.

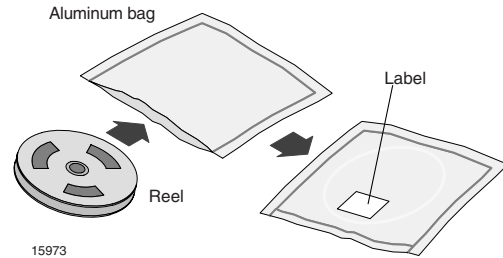

## FINAL PACKING

The sealed reel is packed into a cardboard box. A secondary cardboard box is used for shipping purposes.

## RECOMMENDED METHOD OF STORAGE

Dry box storage is recommended as soon as the aluminum bag has been opened to prevent moisture absorption. The following conditions should be observed, if dry boxes are not available:

- Storage temperature 10 °C to 30 °C
- Storage humidity ≤ 60 % RH max.

After more than 672 hours under these conditions moisture content will be too high for reflow soldering.

In case of moisture absorption, the devices will recover to the former condition by drying under the following condition:

192 hours at 40 °C + 5 °C/- 0 °C and < 5 % RH (dry air/nitrogen) or

96 hours at 60 °C + 5 °C and < 5 % RH for all device containers or

24 hours at 100 °C + 5 °C not suitable for reel or tubes.

An EIA JEDEC Standard JESD22-A112 Level 2a label is included on all dry bags.

w w w . D a

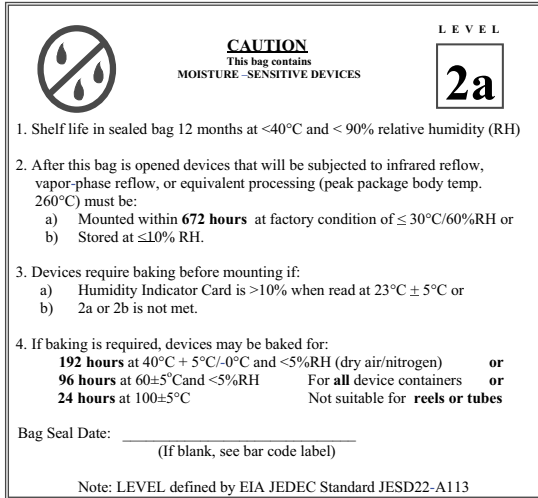

Example of JESD22-A112 Level 2a label

**PACKAGE DIMENSIONS** in millimeters

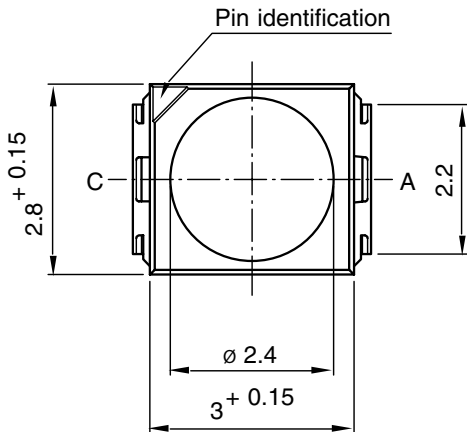
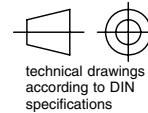
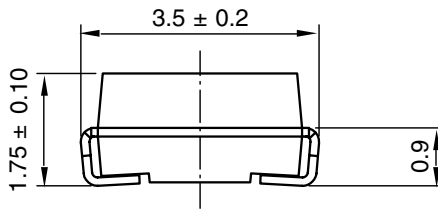

**Mounting Pad Layout**

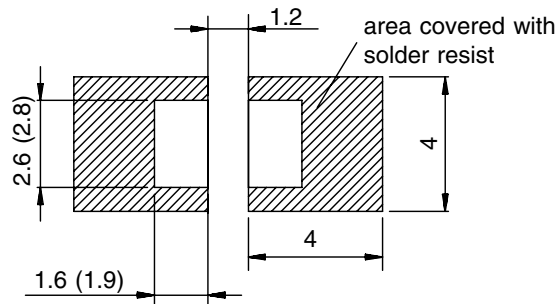

Drawing-No.: 6.541-5025.01-4  
 Issue: 8; 22.11.05  
 95 11314-1

**ESD PRECAUTION**

Proper storage and handling procedures should be followed to prevent ESD damage to the devices especially when they are removed from the Antistatic Shielding Bag. Electro-Static Sensitive Devices warning labels are on the packaging.

**VISHAY SEMICONDUCTORS STANDARD BAR-CODE LABELS**

The Vishay Semiconductors standard bar-code labels are printed at final packing areas. The labels are on each packing unit and contain Vishay Semiconductors specific data.

**OZONE DEPLETING SUBSTANCES POLICY STATEMENT**

It is the policy of Vishay Semiconductor GmbH to

1. Meet all present and future national and international statutory requirements.
2. Regularly and continuously improve the performance of our products, processes, distribution and operating systems with respect to their impact on the health and safety of our employees and the public, as well as their impact on the environment.

It is particular concern to control or eliminate releases of those substances into the atmosphere which are known as ozone depleting substances (ODSs).

The Montreal Protocol (1987) and its London Amendments (1990) intend to severely restrict the use of ODSs and forbid their use within the next ten years. Various national and international initiatives are pressing for an earlier ban on these substances.

Vishay Semiconductor GmbH has been able to use its policy of continuous improvements to eliminate the use of ODSs listed in the following documents.

1. Annex A, B and list of transitional substances of the Montreal Protocol and the London Amendments respectively
2. Class I and II ozone depleting substances in the Clean Air Act Amendments of 1990 by the Environmental Protection Agency (EPA) in the USA
3. Council Decision 88/540/EEC and 91/690/EEC Annex A, B and C (transitional substances) respectively.

Vishay Semiconductor GmbH can certify that our semiconductors are not manufactured with ozone depleting substances and do not contain such substances.

We reserve the right to make changes to improve technical design  
and may do so without further notice.

Parameters can vary in different applications. All operating parameters must be validated for each customer application by the customer. Should the buyer use Vishay Semiconductors products for any unintended or unauthorized application, the buyer shall indemnify Vishay Semiconductors against all claims, costs, damages, and expenses, arising out of, directly or indirectly, any claim of personal damage, injury or death associated with such unintended or unauthorized use.

Vishay Semiconductor GmbH, P.O.B. 3535, D-74025 Heilbronn, Germany



## Disclaimer

All product specifications and data are subject to change without notice.

Vishay Intertechnology, Inc., its affiliates, agents, and employees, and all persons acting on its or their behalf (collectively, "Vishay"), disclaim any and all liability for any errors, inaccuracies or incompleteness contained herein or in any other disclosure relating to any product.

Vishay disclaims any and all liability arising out of the use or application of any product described herein or of any information provided herein to the maximum extent permitted by law. The product specifications do not expand or otherwise modify Vishay's terms and conditions of purchase, including but not limited to the warranty expressed therein, which apply to these products.

No license, express or implied, by estoppel or otherwise, to any intellectual property rights is granted by this document or by any conduct of Vishay.

The products shown herein are not designed for use in medical, life-saving, or life-sustaining applications unless otherwise expressly indicated. Customers using or selling Vishay products not expressly indicated for use in such applications do so entirely at their own risk and agree to fully indemnify Vishay for any damages arising or resulting from such use or sale. Please contact authorized Vishay personnel to obtain written terms and conditions regarding products designed for such applications.

Product names and markings noted herein may be trademarks of their respective owners.