

MITSUBISHI IGBT MODULES
CM100DU-24NFH

HIGH POWER SWITCHING USE

CM100DU-24NFH



- IC 100A
- VCES 1200V
- Insulated Type
- 2-elements in a pack

APPLICATION

High frequency switching use (30kHz to 60kHz).
 Gradient amplifier, Induction heating, power supply, etc.

OUTLINE DRAWING & CIRCUIT DIAGRAM

Dimensions in mm

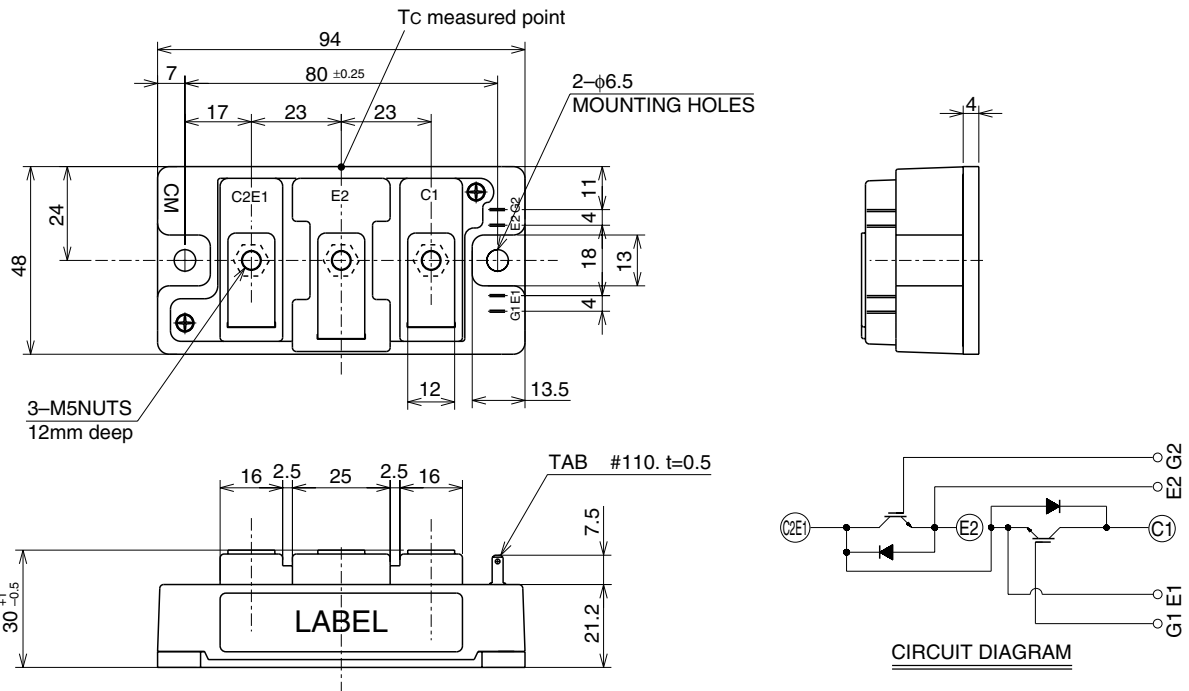

CM100DU-24NFH

HIGH POWER SWITCHING USE

MAXIMUM RATINGS (Tj = 25°C, unless otherwise specified)

Symbol	Parameter	Conditions	Ratings	Unit
VCES	Collector-emitter voltage	G-E Short	1200	V
VGES	Gate-emitter voltage	C-E Short	±20	V
IC	Collector current	Operation (Note 2)	100	A
ICM		Pulse (Note 2)	200	A
IE (Note 1)	Emitter current	Operation (Note 2)	100	A
IEM (Note 1)		Pulse (Note 2)	200	A
PC (Note 3)	Maximum collector dissipation	Tc = 25°C	560	W
PC' (Note 3)	Maximum collector dissipation	Tc' = 25°C ⁴	730	W
Tj	Junction temperature		-40 ~ +150	°C
Tstg	Storage temperature		-40 ~ +125	°C
Viso	Isolation voltage	Terminals to base plate, f = 60Hz, AC 1 minute	2500	Vrms
—	Mounting torque	Main terminals M5 screw	2.5 ~ 3.5	N • m
—		Mounting M6 screw	3.5 ~ 4.5	N • m
—	Weight	Typical value	310	g

ELECTRICAL CHARACTERISTICS (Tj = 25°C, unless otherwise specified)

Symbol	Parameter	Test conditions	Limits			Unit	
			Min.	Typ.	Max.		
ICES	Collector cutoff current	VCE = VCES, VGE = 0V	—	—	1	mA	
VGE(th)	Gate-emitter threshold voltage	IC = 10mA, VCE = 10V	4.5	6	7.5	V	
IGES	Gate leakage current	±VGE = VGES, VCE = 0V	—	—	0.5	µA	
VCE(sat)	Collector-emitter saturation voltage	IC = 100A, VGE = 15V	Tj = 25°C	—	5.0	6.5	V
			Tj = 125°C	—	5.0	—	
Cies	Input capacitance	VCE = 10V VGE = 0V	—	—	16	nF	
Coes	Output capacitance		—	—	1.3	nF	
Cres	Reverse transfer capacitance		—	—	0.3	nF	
QG	Total gate charge	VCC = 600V, IC = 100A, VGE = 15V	—	450	—	nC	
td(on)	Turn-on delay time	VCC = 600V, IC = 100A VGE = ±15V RG = 3.1Ω, Inductive load	—	—	100	ns	
tr	Turn-on rise time		—	—	50	ns	
td(off)	Turn-off delay time		—	—	250	ns	
tf	Turn-off fall time		—	—	150	ns	
trr (Note 1)	Reverse recovery time		IE = 100A	—	—	150	ns
Qrr (Note 1)	Reverse recovery charge		—	5.0	—	µC	
VEC(Note 1)	Emitter-collector voltage	IE = 100A, VGE = 0V	—	—	3.5	V	
Rth(j-c)Q	Thermal resistance*1	IGBT part (1/2 module)	—	—	0.22	K/W	
Rth(j-c)R		FWDi part (1/2 module)	—	—	0.47	K/W	
Rth(c-f)	Contact thermal resistance	Case to heat sink, Thermal compound Applied*2 (1/2 module)	—	0.07	—	K/W	
Rth(j-c)Q	Thermal resistance*4	IGBT part (1/2 module)	—	—	0.17*3	K/W	
Rth(j-c)R		FWDi part (1/2 module)	—	—	0.29*3	K/W	
RG	External gate resistance		3.1	—	31	Ω	

*1 : Case temperature (Tc) measured point is shown in page OUTLINE DRAWING.

*2 : Typical value is measured by using thermally conductive grease of λ = 0.9[W/(m • K)].

*3 : If you use this value, Rth(f-a) should be measured just under the chips.

*4 : Case temperature (Tc) measured point is just under the chips.

Note 1. IE, VEC, trr & Qrr represent characteristics of the anti-parallel, emitter-collector free-wheel diode (FWDi).

2. Pulse width and repetition rate should be such that the device junction temperature (Tj) does not exceed Tjmax rating.

3. Junction temperature (Tj) should not increase beyond 150°C.

4. No short circuit capability is designed.

PERFORMANCE CURVES

OUTPUT CHARACTERISTICS (TYPICAL)

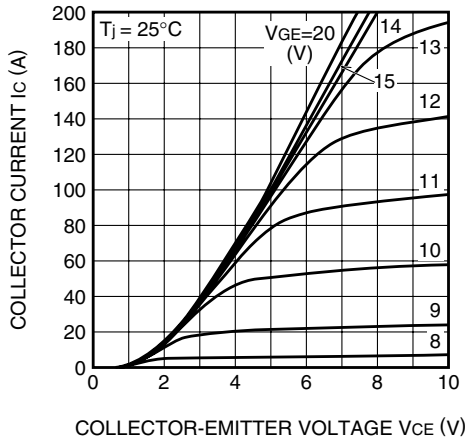

TRANSFER CHARACTERISTICS (TYPICAL)

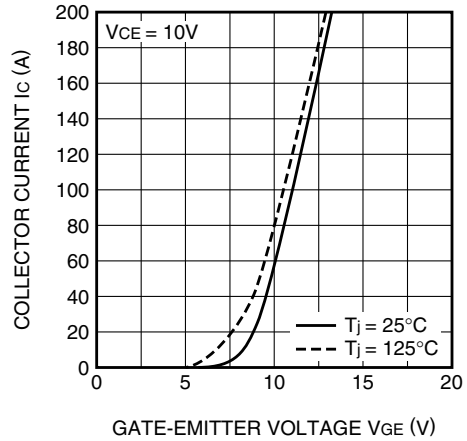

COLLECTOR-EMITTER SATURATION VOLTAGE CHARACTERISTICS (TYPICAL)

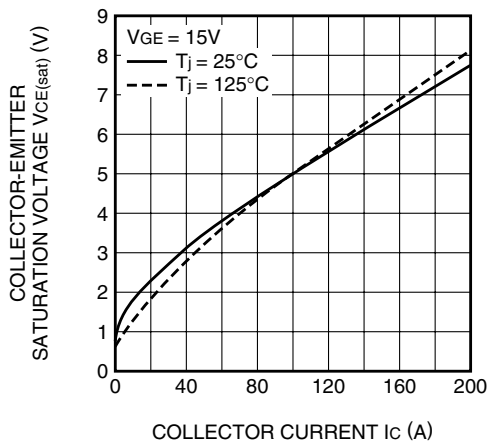

COLLECTOR-EMITTER SATURATION VOLTAGE CHARACTERISTICS (TYPICAL)

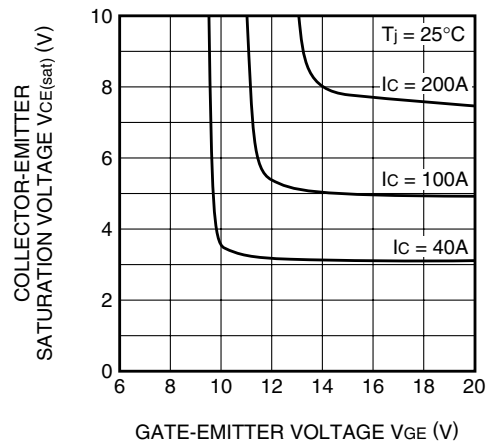

FREE-WHEEL DIODE FORWARD CHARACTERISTICS (TYPICAL)

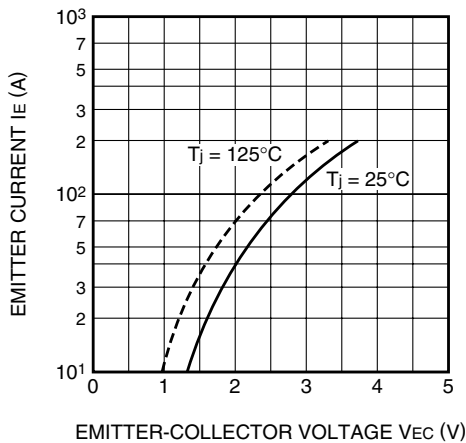

CAPACITANCE CHARACTERISTICS (TYPICAL)

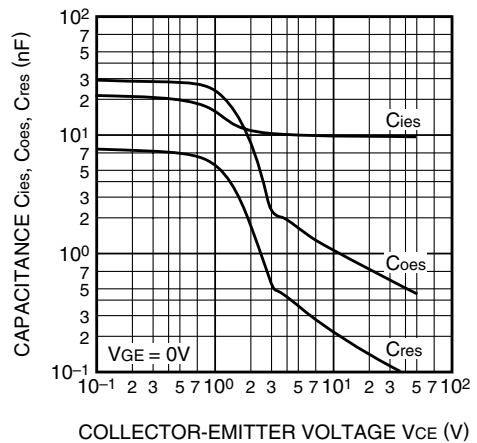

HALF-BRIDGE SWITCHING TIME CHARACTERISTICS (TYPICAL)

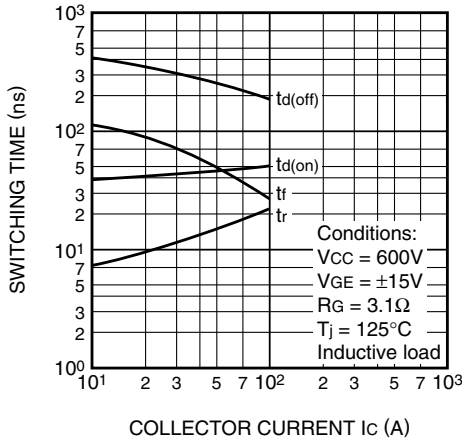

REVERSE RECOVERY CHARACTERISTICS OF FREE-WHEEL DIODE (TYPICAL)

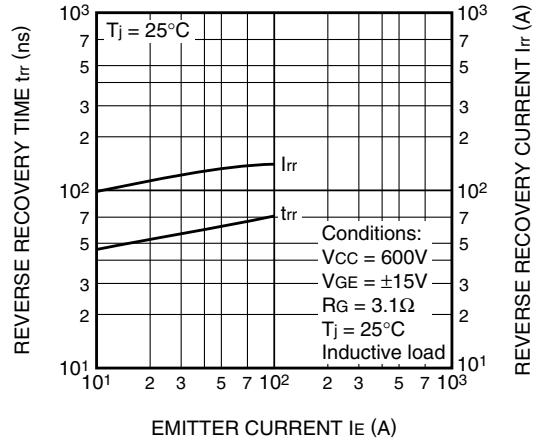

TRANSIENT THERMAL IMPEDANCE CHARACTERISTICS (IGBT part)

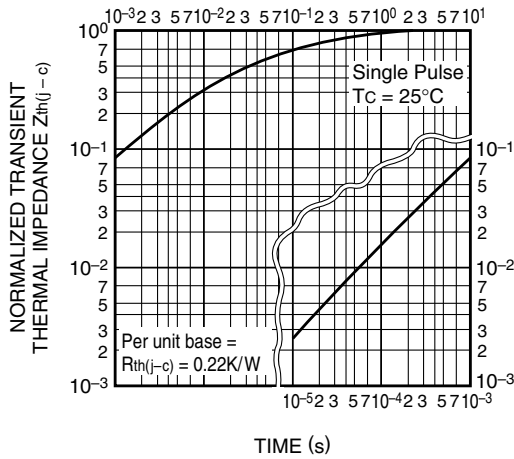

TRANSIENT THERMAL IMPEDANCE CHARACTERISTICS (FWDi part)

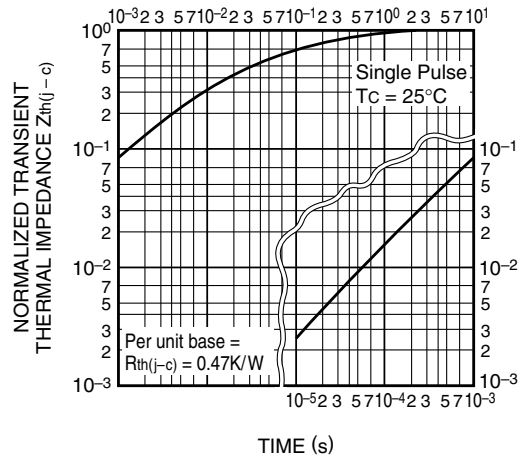

GATE CHARGE CHARACTERISTICS (TYPICAL)

