

PRECISION 4.0 VOLT MICROPOWER VOLTAGE REFERENCE

ZRA400

ISSUE 1 - JANUARY 1996

DEVICE DESCRIPTION

The ZRA400 uses a bandgap circuit design to achieve a precision micropower voltage reference of 4.096 volts. The device is available in small outline surface mount packages, ideal for applications where space saving is important.

The ZRA400 design provides a stable voltage without an external capacitor and is stable with capacitive loads. The ZRA400 is recommended for operation between 50 μ A and 5mA and so is ideally suited to low power and battery powered applications.

Excellent performance is maintained to a suggested absolute maximum of 25mA, however the rugged design and 20 volt processing allows the reference to withstand transient effects and currents up to 200mA. Superior switching capability allows the device to reach stable operating conditions in only a few microseconds.

- No stabilising capacitor required
- Typical T_C 15ppm/ $^{\circ}$ C
- Typical slope resistance 0.55 Ω
- \pm 3%, 2% and 1% tolerance
- Industrial temperature range
- Operating current 50 μ A to 5mA

APPLICATIONS

- Battery powered and portable equipment.
- Metering and measurement systems.
- Instrumentation.
- Test equipment.
- Data acquisition systems.
- Precision power supplies.
- Crystal oscillators

FEATURES

- Small outline SO8, SOT23 and TO92 style packages.

SCHEMATIC DIAGRAM

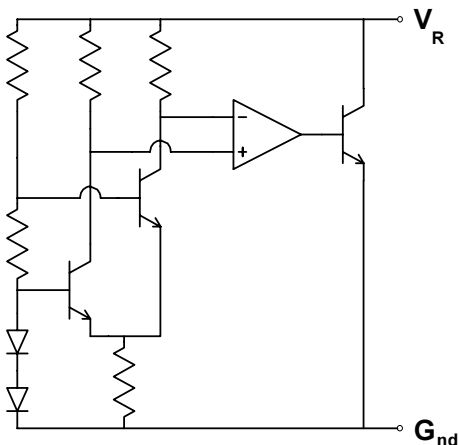

ZRA400

ABSOLUTE MAXIMUM RATING

Reverse Current	25mA
Forward Current	25mA
Operating Temperature	-40 to 85°C
Storage Temperature	-55 to 125°C

Power Dissipation (T_{amb}=25°C)

SOT23	330mW
E-Line, 3 pin (TO92)	500mW
E-Line, 2 pin (TO92)	500mW
SO8	625mW

ELECTRICAL CHARACTERISTICS

TEST CONDITIONS (Unless otherwise stated) T_{amb}=25°C

SYMBOL	PARAMETER	CONDITIONS	LIMITS			TOL. %	UNITS
			MIN	TYP	MAX		
V _R	Reverse Breakdown Voltage	I _R =150μA	4.05 4.01 3.97	4.096 4.096 4.096	4.14 4.18 4.22	1 2 3	V
I _{MIN}	Minimum Operating Current			25	50		μA
I _R	Recommended Operating Current		0.05		5		mA
T _C †	Average Reverse Breakdown Voltage Temp. Co.	I _{R(min)} to I _{R(max)}		15	50		ppm/°C
R _S §	Slope Resistance			0.55	2		Ω
Z _R	Reverse Dynamic Impedance	I _R = 1mA f = 100Hz I _{AC} = 0.1 I _R		0.5	1.2		Ω

$$† T_C = \frac{V_R \text{ Change} \times 1000000}{V_R \times \text{Temperature Change}}$$

$$§ R_S = \frac{V_R \text{ Change}(I_R(\text{min}) \text{ to } I_R(\text{max}))}{I_R(\text{max}) - I_R(\text{min})}$$

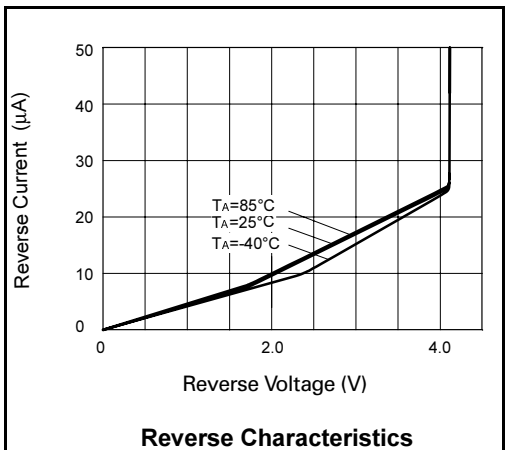

ZRA400

TYPICAL CHARACTERISTICS

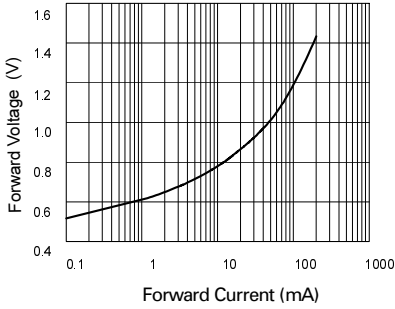

Forward Characteristics

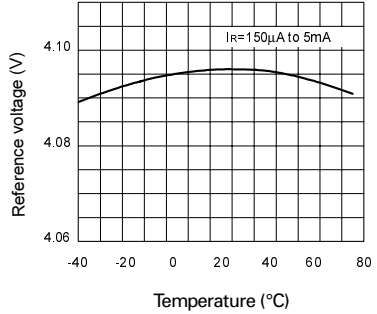

Temperature Drift

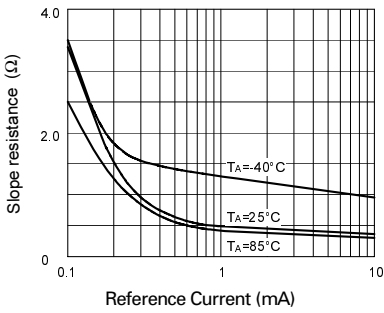

Slope Resistance v Current

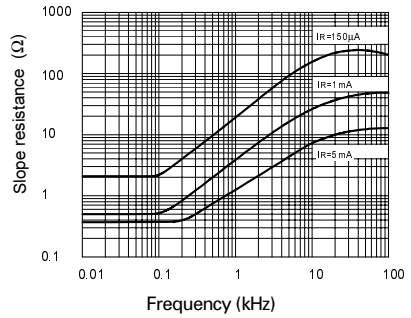

Slope Resistance v Frequency

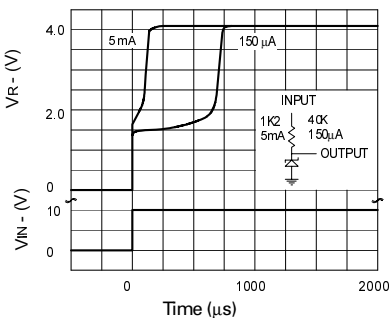

**Transient Response
(Single Pulse)**

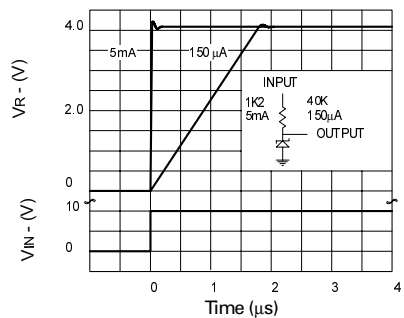

**Transient Response
(Repetitive Pulse)**

ZRA400

CONNECTION DIAGRAMS

E-Line, 2 pin Package Suffix – Y

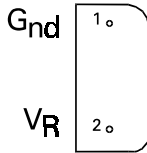

Bottom View

E-Line, 3 pin, Rev Package Suffix – R

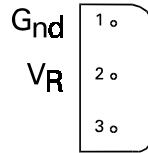

*Bottom View –
Pin 3 floating or connected to pin 1*

E-Line, 3 pin Package Suffix – A

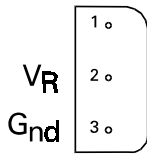

*Bottom View –
Pin 1 floating or connected to pin 3*

SO8 Package Suffix – N8

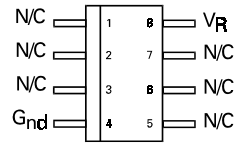

Top View

SOT23 Package Suffix – F

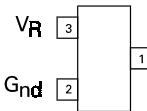

*Top View –
Pin 1 floating or connected to pin 2*

ZRA400

ORDERING INFORMATION

Part No	Tol%	Package	Partmark
ZRA400A03	3	E-Line •	ZRA40003
ZRA400A02	2	E-Line •	ZRA40002
ZRA400A01	1	E-Line •	ZRA40001
ZRA400F03	3	SOT23	40A
ZRA400F02	2	SOT23	40B
ZRA400F01	1	SOT23	40C
ZRA400N803	3	SO8	ZRA40003
ZRA400N802	2	SO8	ZRA40002
ZRA400N801	1	SO8	ZRA40001

Part No	Tol%	Package	Partmark
ZRA400R03	3	E-Line *	ZRA400R3
ZRA400R02	2	E-Line *	ZRA400R2
ZRA400R01	1	E-Line *	ZRA400R1
ZRA400Y03	3	E-Line †	ZRA40003
ZRA400Y02	2	E-Line †	ZRA40002
ZRA400Y01	1	E-Line †	ZRA40001

* E-Line 3 pin Reversed
† E-Line 2 pin
• E-Line 3 pin