

# BIF3

## 5-800 MHz Internally Matched IF Amplifier



### Device Features

- OIP3 = 44.0 dBm @ 70 MHz
- Gain = 20.3 dB @ 70 MHz
- Output P1 dB = 23.5 dBm @ 70 MHz
- 50 Ω Cascadable
- Patented over voltage protection
- Lead-free/RoHS-compliant SOT-89 SMT package



### Product Description

BeRex's BIF3 is a high performance InGaP/ GaAs HBT MMIC amplifier, internally matched to 50 Ohms and uses a patented **over voltage protection** circuit to protect a internal device. The BIF3 is designed for high linearity IF amplifier that requires excellent gain, high OIP3 and flatness. It is packaged in a RoHS-compliant with SOT-89 surface mount package.

### Typical Performance<sup>1</sup>

Parameter	Frequency					Unit
	70	140	250	500	800	
Gain	20.3	20.2	19.9	19.0	17.9	dB
S11	-19.0	-18.0	-15.0	-11.0	-8.0	dB
S22	-16.0	-17.0	-16.0	-13.0	-11.0	dB
OIP3 <sup>2</sup>	44.0	41.5	40.5	40.5	39.5	dBm
P1dB	23.5	24.5	24.5	24.2	24.0	dBm
Noise Figure	5.1	5.2	5.2	5.3	5.3	dB

<sup>1</sup> Device performance \_ measured on a BeRex evaluation board at 25°C, 50 Ω system.

<sup>2</sup> OIP3 \_ measured with two tones at an output of 8 dBm per tone separated by 1 MHz.

### Applications

- Base station Infrastructure/RFID
- Commercial/Industrial/Military wireless system

### Applications Circuit

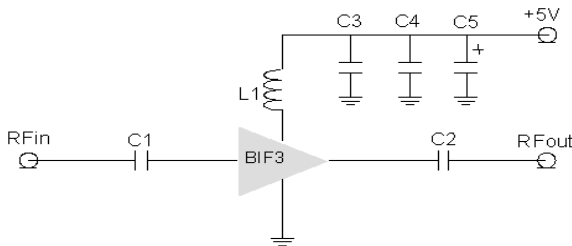

\*C1, C2=8200pF ± 5%; C3 = 100 pF ± 5%; C4 = 1000pF ± 5%

\*C5 = 10uF; L1 = 680nH ± 5%

	Min.	Typical	Max.	Unit
Bandwidth	5		800	MHz
I <sub>c</sub> @ (V <sub>c</sub> = 5V)	75	85	97	mA
V <sub>c</sub>		5.0		V
dG/dT		-0.004		dB/°C
R <sub>TH</sub>		45		°C/W

### Absolute Maximum Ratings

Parameter	Rating	Unit
Operating Case Temperature	-40 to +85	°C
Storage Temperature	-55 to +155	°C
Junction Temperature	+220	°C
Operating Voltage	+7.0	V
Supply Current	140	mA
Input RF Power	23	dBm

Operation of this device above any of these parameters may result in permanent damage.

Above 7V, a device goes to protection mode.

# BIF3

## 5-800 MHz Internally Matched IF Amplifier



### V-I Characteristics

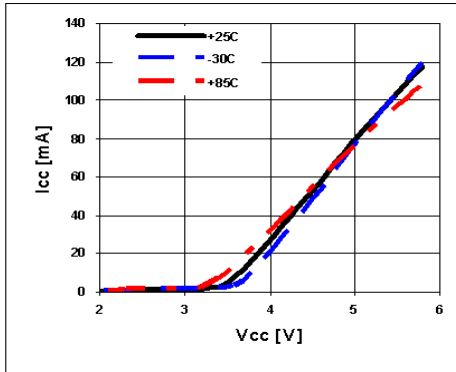

### BeRex SOT89 Evaluation Board

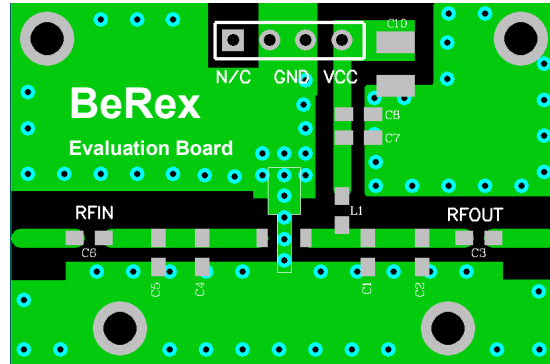

\*Dielectric constant \_ 4.2 \*RF pattern width 52mil \*31mil thick FR4 PCB

### Typical Device Data

S-parameters (Vc=5V, Ic=80mA, T=25°C)

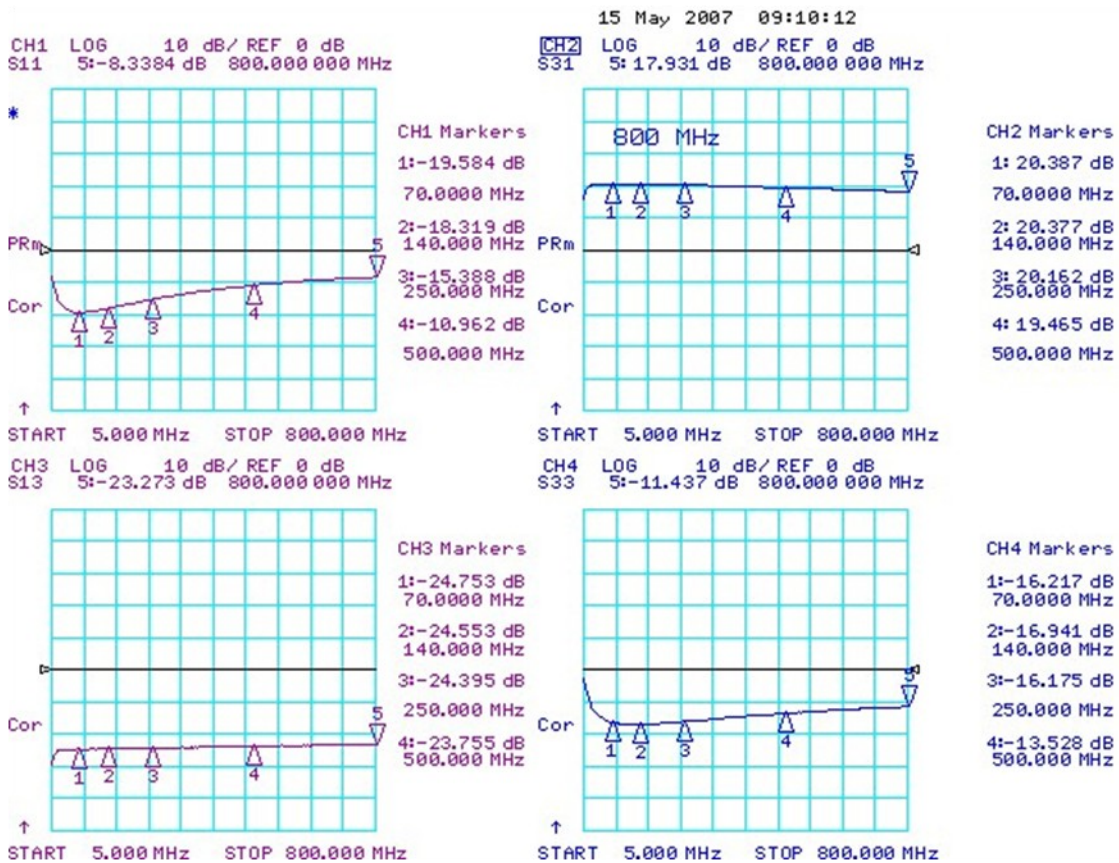

# BIF3



## 5-800 MHz Internally Matched IF Amplifier

### S-Parameter

(Vdevice = 5.0V, Icc = 85mA, T = 25 °C, calibrated to device leads)

Freq [MHz]	S11 [Mag]	S11 [Ang]	S21 [Mag]	S21 [Ang]	S12 [Mag]	S12 [Ang]	S22 [Mag]	S22 [Ang]
100	0.624	178.2	10.523	169.9	0.059	1.5	0.096	-26.0
500	0.678	164.5	7.809	137.3	0.069	0.3	0.162	-107.1
1000	0.748	144.2	5.812	155.4	0.067	-0.4	0.223	-156.6
1500	0.788	121.2	4.823	100.6	0.078	-7.1	0.272	167.3
2000	0.790	102.1	4.095	82.6	0.070	-23.9	0.271	140.3
2500	0.861	76.9	3.935	74.1	0.076	-17.5	0.305	116.8
3000	0.873	54.1	4.121	51.6	0.072	-41.4	0.327	94.2
3500	0.955	26.4	3.614	30.1	0.061	-39.1	0.347	75.9
4000	1.037	-3.3	3.252	11.4	0.060	-53.2	0.362	55.0

Typical Performance (Vd = 5V, Ic = 85mA, T = 25°C)

Freq	MHz	70	140	250	500	800
S21	dB	20.3	20.2	19.9	19.0	17.9
S11	dB	-19	-18	-15	-11	-8
S22	dB	-16	-17	-16	-13	-11
P1	dBm	23.5	24.5	24.5	24.2	24.0
OIP3	dBm	44	41.5	40.5	40.5	39.5
NF	dB	5.1	5.2	5.2	5.3	5.3

Typical Performance (Vd = 4.7V, Ic = 64mA, T = 25°C)

Freq	MHz	70	140	250	500	800
S21	dB	20.1	19.9	19.7	18.9	17.6
S11	dB	-27.2	-24.6	-16.8	-11.3	-9.3
S22	dB	-13.1	-12.6	-13	-12.5	-9.7
P1	dBm	22.9	23.5	23.3	23.3	22.7
OIP3	dBm	35.0	38.5	39.5	36.5	35.3
NF	dB	5.1	5.2	5.2	5.3	5.3

Typical Performance (Vd = 4.5V, Ic = 54mA, T = 25°C)

Freq	MHz	70	140	250	500	800
S21	dB	20.2	20.2	19.8	18.7	17.5
S11	dB	-18.8	-19	-16.1	-11.8	-9.2
S22	dB	-14.1	-16	-15.1	-11.8	-9.6
P1	dBm	22.1	23.0	23.1	22.6	22.2
OIP3	dBm	34.5	37.5	34.5	35.5	34.5
NF	dB	5.1	5.2	5.2	5.3	5.3

# BIF3

## 5-800 MHz Internally Matched IF Amplifier

---



Typical Performance (Vd = 4V, Ic = 28mA, T = 25°C)

Freq	MHz	70	140	250	500	800
S21	dB	19.5	19.4	19.1	18.1	16.8
S11	dB	-18.4	-18.5	-15.8	-11.5	-8.9
S22	dB	-12.3	-13.8	-13.5	-11.3	-9.4
P1	dBm	20.7	21.2	21.2	20.7	13.5
OIP3	dBm	35	29	27.5	25.5	31
NF	dB	5.1	5.2	5.2	5.3	5.3

# BIF3

## 5-800 MHz Internally Matched IF Amplifier



### Device Performance

#### OIP3

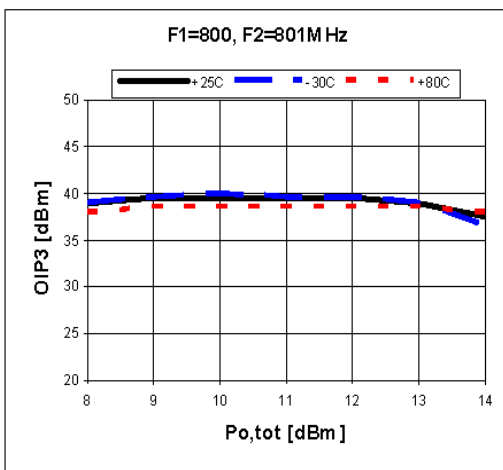
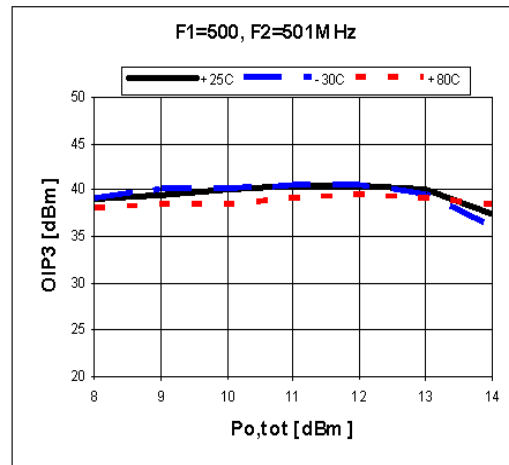
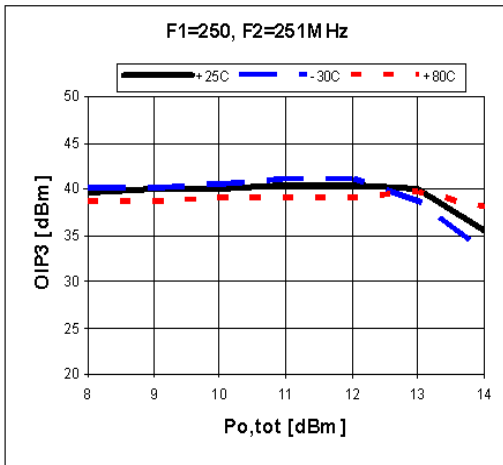
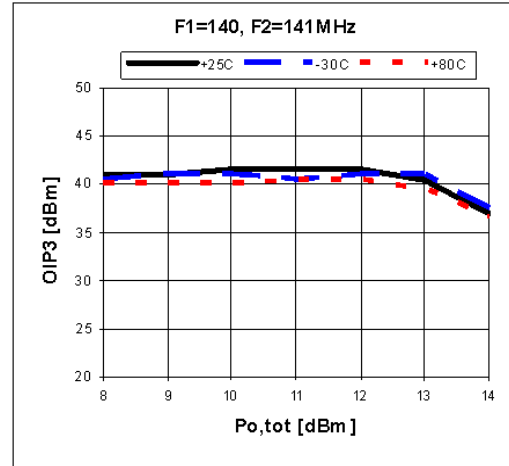
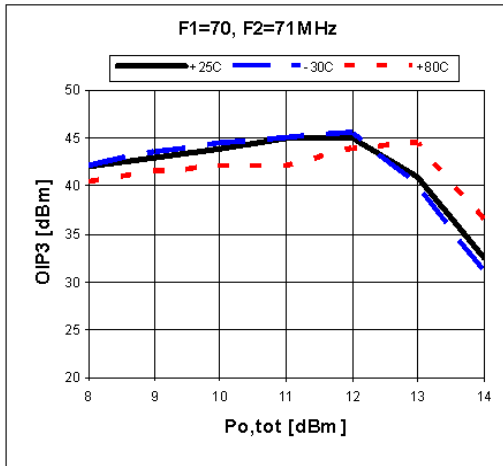

# BIF3

## 5-800 MHz Internally Matched IF Amplifier



### ACPR

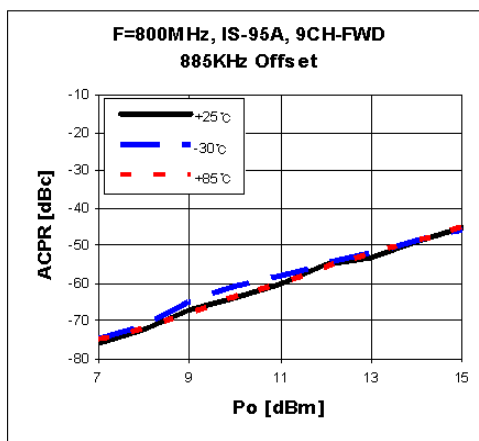
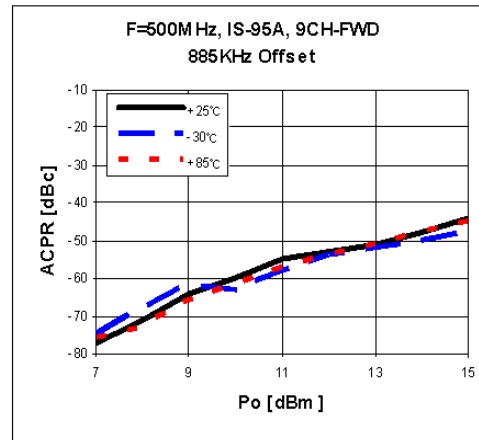
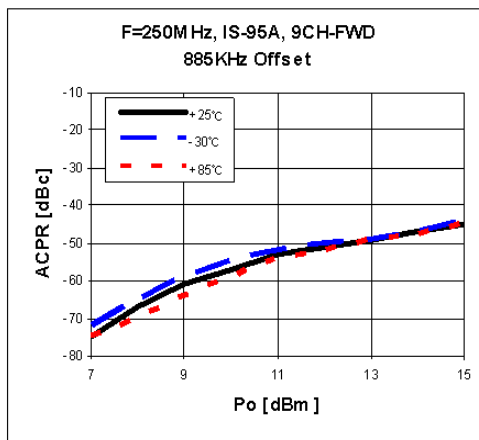
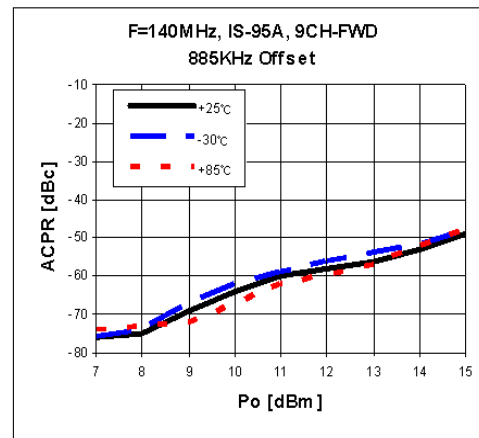
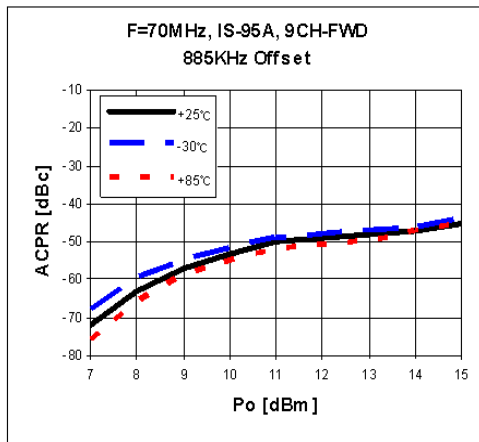

# BIF3



## 5-800 MHz Internally Matched IF Amplifier

### ACLR

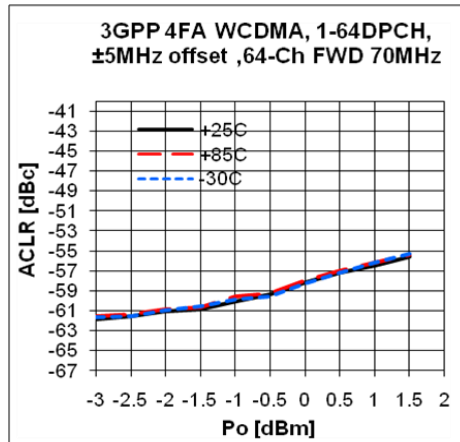

### S-Parameters(S11/S22)

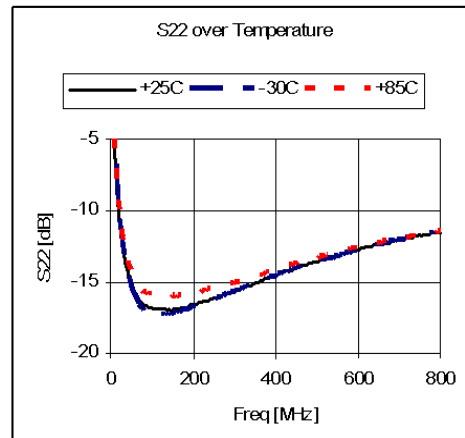
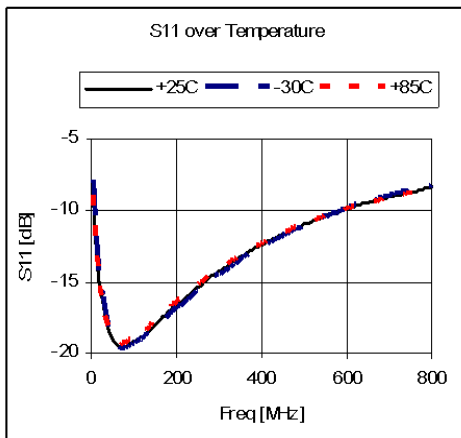

### Gain Flatness

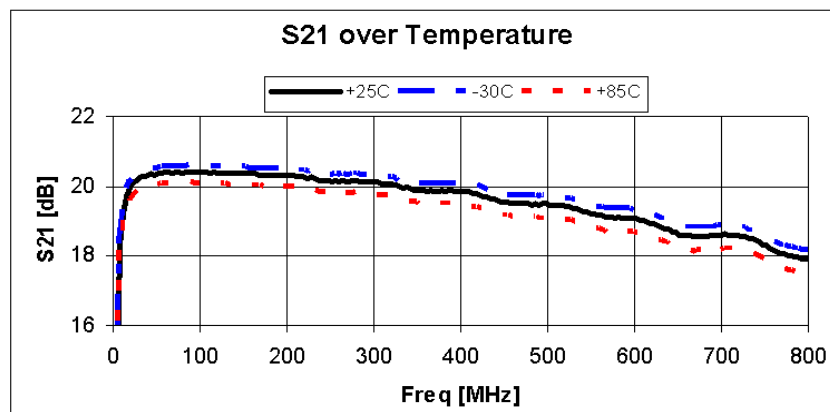

# BIF3

## 5-800 MHz Internally Matched IF Amplifier



### Package Outline Dimension

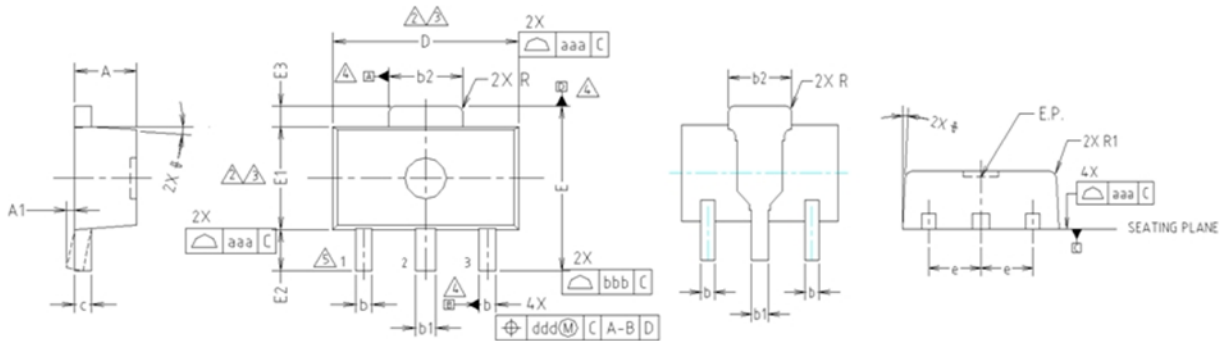

- NOTE:**  
1. DIMENSIONS IN MILLIMETERS.
- ⚠ DIMENSION D DOES NOT INCLUDE MOLD FLASH, PROTRUSIONS OR GATE BURRS. MOLD FLASH, PROTRUSIONS OR GATE BURRS SHALL NOT EXCEED 0.5mm PER END. DIMENSION E1 DOES NOT INCLUDE INTERLEAD FLASH OR PROTRUSION. INTERLEAD FLASH OR PROTRUSION SHALL NOT EXCEED 0.5mm PER SIDE.
  - ⚠ DIMENSIONS D AND E1 ARE DETERMINED AT THE OUTMOST EXTREMES OF THE PLASTIC BODY EXCLUSIVE OF MOLD FLASH, TIE BAR BURRS, GATE BURRS AND INTERLEAD FLASH, BUT INCLUDING ANY MISMATCH BETWEEN THE TOP AND BOTTOM OF THE PLASTIC BODY.
  - ⚠ DATUMS A, B AND D TO BE DETERMINED 0.18mm FROM THE LEAD TIP.
  - ⚠ TERMINAL NUMBERS ARE SHOWN FOR REFERENCE ONLY.

SYMBOL	MILLIMETERS			NOTE
	MINIMUM	NOMINAL	MAXIMUM	
A	1.40	1.50	1.60	
A1	0.00	—	0.10	
b	0.38	0.42	0.48	
b1	0.48	0.52	0.58	
b2	1.79	1.82	1.87	
c	0.40	0.42	0.46	
D	4.40	4.50	4.70	2,3
E	3.70	4.00	4.30	
E1	2.40	2.50	2.70	2,3
E2	0.80	1.00	1.20	
E3	0.40	0.50	0.60	
e	1.50 TYP.			
φ	4° TYP.			
R	0.15 TYP.			
R1	—	—	0.20	
SYMBOL	TOLERANCES OF FORM AND POSITION		NOTE	
aaa	0.15			
bbb	0.20			
ccc	0.10			
ddd	0.10			

### Suggested PCB Land Pattern and PAD Layout

PCB Land Pattern

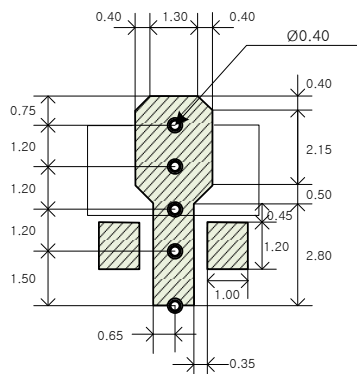

Note : All dimension \_ millimeters

PCB lay out \_ on BeRex website

PCB Mounting

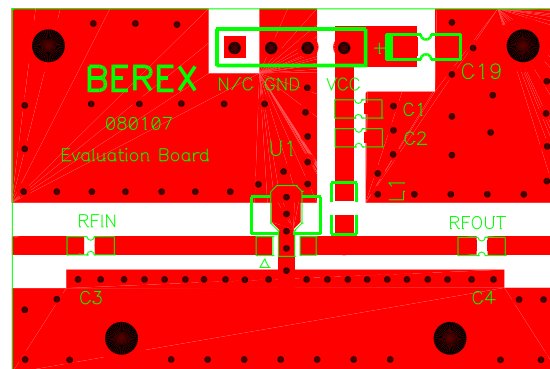



# BIF3

5-800 MHz Internally Matched IF Amplifier



## Tape & Reel

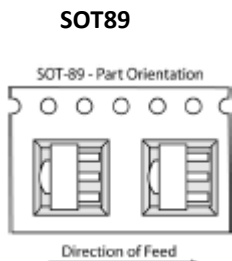

Packaging information:

Tape Width (mm): 12

Reel Size (inches): 7

Device Cavity Pitch (mm): 8

Devices Per Reel: 1000

## Lead plating finish

100% Tin Matte finish

(All BeRex products undergoes a 1 hour, 150 degree C, Anneal bake to eliminate thin whisker growth concerns.)

## MSL / ESD Rating

<b>ESD Rating:</b>	Class 1C
<b>Value:</b>	<b>Passes &lt;2000V</b>
<b>Test:</b>	Human Body Model (HBM)
<b>Standard:</b>	JEDEC Standard JESD22-A114B
<b>MSL Rating:</b>	<b>Level 1 at +265°C convection reflow</b>
<b>Standard:</b>	JEDEC Standard J-STD-020

## NATO CAGE code:

2	N	9	6	F
---	---	---	---	---