

Features

- LOW POWER CONSUMPTION.
- POPULAR T-1 DIAMETER PACKAGE.
- GENERAL PURPOSE LEADS.
- RELIABLE AND RUGGED.
- LONG LIFE - SOLID STATE RELIABILITY.
- AVAILABLE ON TAPE AND REEL.
- 14V INTERNAL RESISTOR.
- RoHS COMPLIANT.

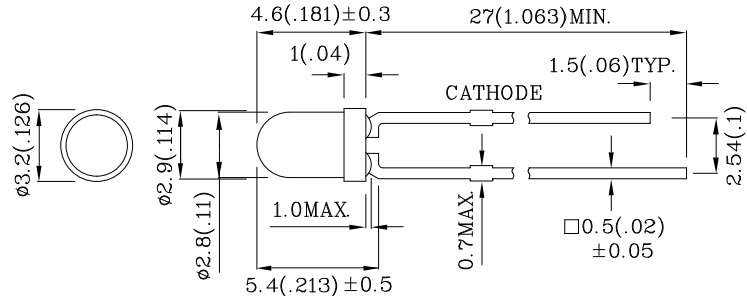

Notes:

1. All dimensions are in millimeters (inches).
2. Tolerance is ± 0.25(0.01") unless otherwise noted.
3. Specifications are subject to change without notice.

Absolute maximum ratings (TA=25°C)		MG (GaP)	Unit
Reverse Voltage	V _R	5	V
Forward Voltage	V _F	16	V
Power Dissipation	P _T	160	mW
Operating Temperature	T _A	-40 ~ +70	°C
Storage Temperature	T _{stg}	-40 ~ +85	
Lead Solder Temperature [2mm Below Package Base]	260°C For 3 Seconds		
Lead Solder Temperature [5mm Below Package Base]	260°C For 5 Seconds		

Operating Characteristics (TA=25°C)		MG (GaP)	Unit
Forward Current (Typ.) (V _F =14V)	I _F	10.5	mA
Forward Current (Max.) (V _F =14V)	I _F	13.5	mA
Reverse Current (Max.) (V _R =14V)	I _R	10	uA
Wavelength of Peak Emission (Typ.) (V _F =14V)	λ P	565	nm
Spectral Line Full Width At Half-Maximum (Typ.) (V _F =14V)	λ D	568	nm
Spectral Line Half-Width (V _F =14V) (Typ.)	Δλ	30	nm

Part Number	Emitting Color	Emitting Material	Lens-color	Luminous Intensity (V=14V) mcd		Wavelength nm λ P	Viewing Angle 2 θ 1/2
				min.	typ.		
LMG11D14V	Green	GaP	Green Diffused	8	19	565	40°

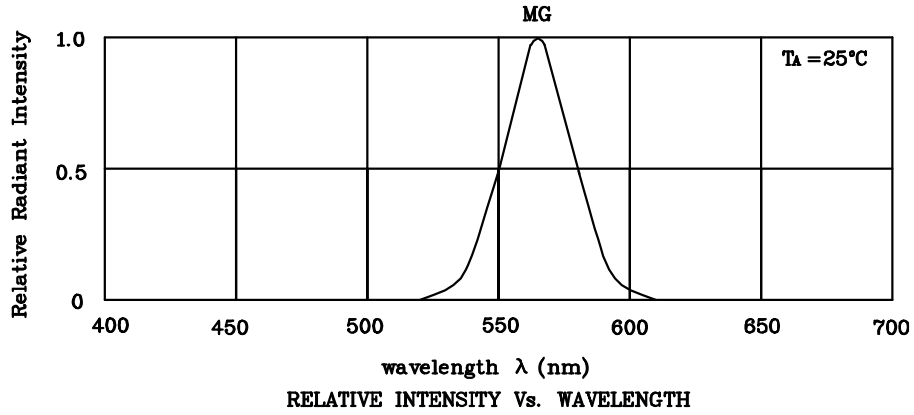

❖ MG

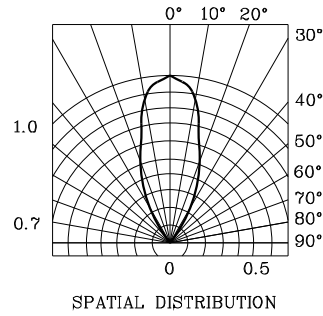
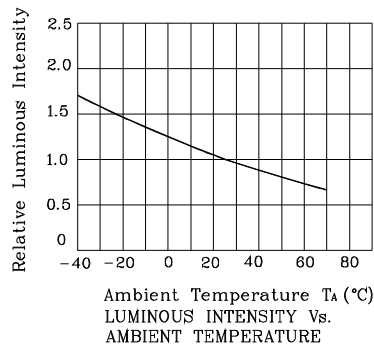
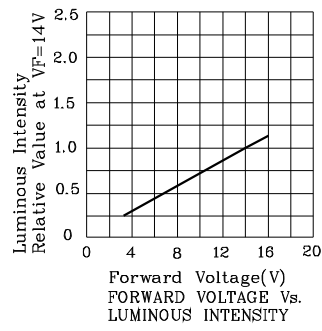
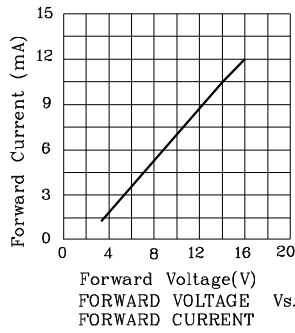

Wave Soldering Profile For Lead-free Through-hole LED.



NOTES:

1. Recommend the wave temperature 245°C~260°C. The maximum soldering temperature should be less than 260°C.
2. Do not apply stress on epoxy resins when temperature is over 85 degree°C.
3. The soldering profile apply to the lead free soldering (Sn/Cu/Ag alloy).
4. No more than once.

Remarks:

If special sorting is required (e.g. binning based on luminous intensity / luminous flux or wavelength), the typical accuracy of the sorting process is as follows:

1. Wavelength: +/-1nm.
2. Luminous Intensity / Luminous Flux: +/-15%.

Note: Accuracy may depend on the sorting parameters.

PACKING & LABEL SPECIFICATIONS

LMG11D14V

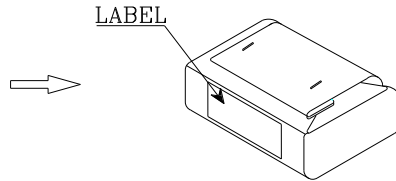
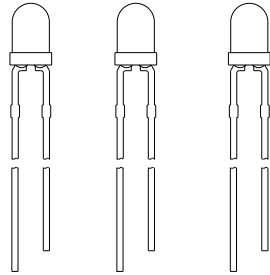

1,000PCS/BAG

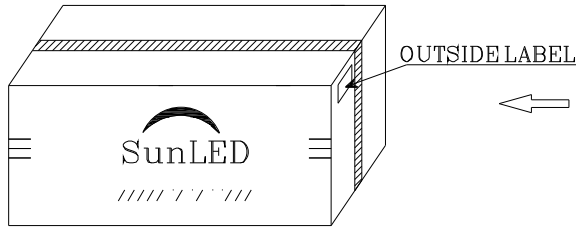

56K / BOX

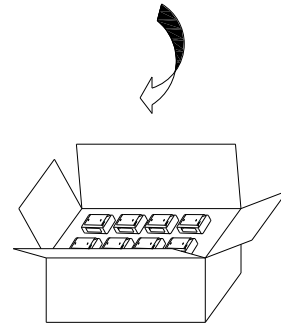

28K/ BOX

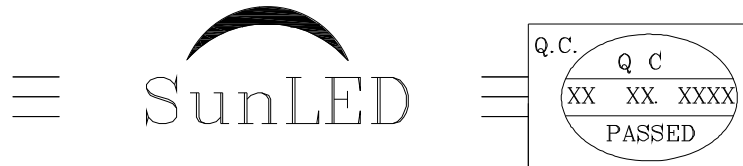

P/NO : Lxx11x	
QTY : 1,000 pcs	CODE: XXX
S/N : XX	
LOT NO:	
 XXXXXXXXXXXXXXXXXXXXXXXX	
RoHS Compliant	