

AsahiKASEI
ASAHI KASEI MICRODEVICES

AKD4480-SB
AK4480 Evaluation Board Rev.2

General Description

AKD4480-SB is an evaluation board, which is 32Bit $\Delta \Sigma$ DAC. The AKD4480-SB includes a LPF which can add differential analog outputs from the AK4480 and also has a digital interface. Therefore, it is easy to evaluate sound quality of the AK4480.

Ordering Guide

AKD4480-SB --- Evaluation board for AK4480

Function

- On-board analog output buffer circuit
- On-board digital audio interface. (AK4115)

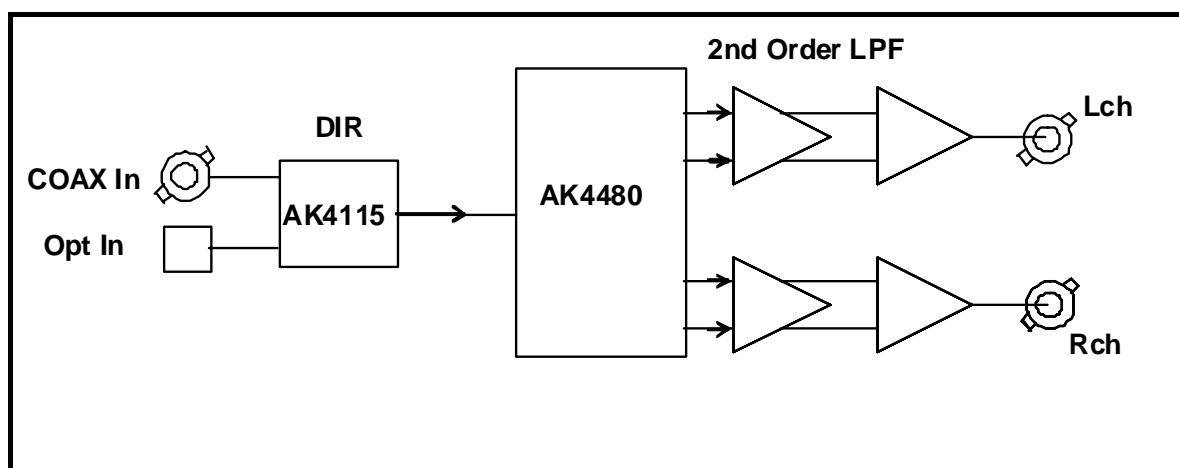

Figure 1. AKD4480-SB Block Diagram

* Circuit diagram are attached at the end of this manual.
COAX is recommended for an evaluation of the Sound quality.

■ Operation sequence

1) Set up the power supply lines. (See “Other jumpers’ set-up”.)

Name	Color	Voltage	Comments	Attention
+15V	Red	+12~+15V	Regulator, Power supply for Op-amp.	This jack is always needed. Power line
-15V	Blue	-12~-15V	Power supply for Op-amp.	This jack is always needed. Power line
AGND	Black	0V	GND	This jack is always needed.

Table 1. Set up of power supply lines

Each supply line should be distributed from the power supply unit.

2) Set-up the jumper pins

3) Set-up the DIP switches. (See the followings.)

4) Power on

The AK4480 should be reset once bringing SW3 (PDN) “L” upon power-up.

■ Evaluation mode

1. DIR (COAX) (default)

The DIR generates MCLK, BICK, LRCK and SDATA from the received data through BNC connector (J7). It is possible for the evaluation using such as CD test disk.

Setting: R87 = open; R88 = short (0Ω)

COAX is recommended for an evaluation of the Sound quality.

2. DIR (Optical)

The DIR generates MCLK, BICK, LRCK and SDATA from the received data through Optical connector (PORT2). It is possible for the evaluation using such as CD test disk.

Setting: R87 = short (0Ω); R88 = open

3. All clocks are fed through the PORT1.

Setting: R54, R55, R56, R58 = open
R50, R51, R52 = 100Ω ; R53 = 5.1Ω

■ DIP Switch setting

[SW1]: AK4115 setting

No.	Pin	OFF	ON	Default
1	OCKS1	Master Clock setting of AK4115 Refer to Table 4		ON
2	OCKS0			OFF

Table 2. SW1 setting

[SW2]: AK4480 setting

No.	Pin	OFF	ON	Default
1	-	-	-	-
2	P/S	Serial mode	Parallel mode	OFF

Table 3. SW2 setting

The frequency of the master clock output is set by OCKS0 and OCKS1 as shown in Table 4.

OCKS1	OCKS0	MCLK Frequency
OFF	OFF	256fs @ fs=88.2/96kHz
ON	OFF	512fs @ fs=32/44.1/48kHz
ON	ON	128fs @ fs=176.4/192kHz

(Default)

Table 4. MCLK Setting

■ SW3 setting

[SW3] (PDN): Reset of AK4480. Select “H” during operation.

■ External Analog Circuit

The differential output circuit and LPF is implemented on board. The differential outputs of AK4480 is buffered by non-inverted circuit (2nd order LPF, $f_c=106.4\text{k}$, $Q=0.698$, $G=+3.9\text{dB}$). LPF adds differential outputs (1st order LPF, $f_c=284\text{k}$, $G=-0.84\text{dB}$). LME49710NA is used for op-amp on this board that has low noise and high voltage tolerance characteristics. Analog signal is output via BNC connectors on the board. The output level is about 2.8V_{rms} (typ@VREF=5.0V) by BNC.

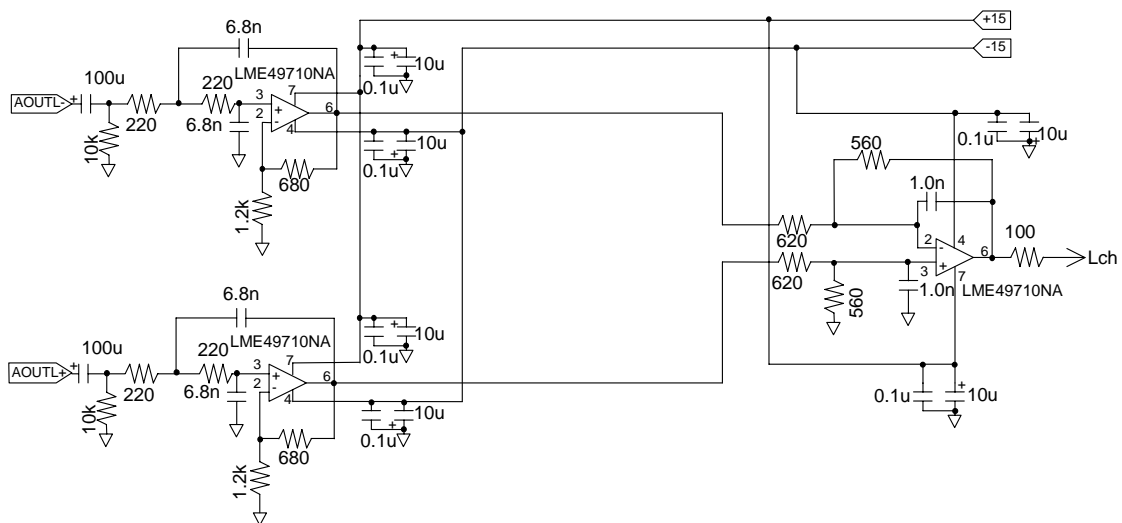

Figure 2. External Analog Filter

AKD4480-SB Filter	40kHz (Double)	80kHz (quad)
Internal Filter	-0.3dB	-1dB
External LPF	-0.12dB	-1.3dB
Total	-0.42dB	-2.3dB

This table shows typical value.

Table 5. Frequency Responses

Control Software Manual

■ Set-up of evaluation board and control software

1. Set up the AKD4480-SB according to previous term.
2. Connect IBM-AT compatible PC with AKD4480-SB by 10-line type flat cable (packed with AKD4480-SB). Take care of the direction of 10pin header. (Please install the driver in the CD-ROM when this control software is used on Windows 2000/XP. Please refer "Installation Manual of Control Software Driver by AKM device control software". In case of Windows95/98/ME, this installation is not needed. This control software does not operate on Windows NT.)
3. Insert the CD-ROM labeled "AKD4480-SB Evaluation Kit" into the CD-ROM drive.
4. Access the CD-ROM drive and double-click the icon of "akd4480-sb.exe" to set up the control program.
5. Then please evaluate according to the follows.

■ Operation flow

Keep the following flow.

1. Set up the control program according to explanation above.
2. Click "Port Reset" button.

■ Explanation of each buttons

1. [Port Reset]: Set up the USB interface board (AKDUSBIF-A).
2. [Write default]: Initialize the register of AK4480.
3. [All write]: Write all registers that is currently displayed.
4. [Function1]: Dialog to write data by keyboard operation.
5. [Function2]: Dialog to write data by keyboard operation.
6. [Function3]: The sequence of register setting can be set and executed.
7. [Function4]: The sequence that is created on [Function3] can be assigned to buttons and executed.
8. [Function5]: The register setting that is created by [SAVE] function on main window can be assigned to buttons and executed.
9. [SAVE]: Save the current register setting.
10. [OPEN]: Write the saved values to all register.
11. [Write]: Dialog to write data by mouse operation.

■ Indication of data

Input data is indicated on the register map. Red letter indicates "H" or "1" and blue one indicates "L" or "0". Blank is the part that is not defined in the datasheet.

■ Explanation of each dialog

1. [Write Dialog]: Dialog to write data by mouse operation

There are dialogs corresponding to each register.

Click the [Write] button corresponding to each register to set up the dialog. If you check the check box, data becomes “H” or “1”. If not, “L” or “0”.

If you want to write the input data to AK4480, click [OK] button. If not, click [Cancel] button.

2. [Function1 Dialog]: Dialog to write data by keyboard operation

Address Box:	Input registers address in 2 figures of hexadecimal.
Data Box:	Input registers data in 2 figures of hexadecimal.

If you want to write the input data to AK4480, click [OK] button. If not, click [Cancel] button.

3. [Function2 Dialog]: Dialog to evaluate ATT

Address Box:	Input registers address in 2 figures of hexadecimal.
Start Data Box:	Input starts data in 2 figures of hexadecimal.
End Data Box:	Input end data in 2 figures of hexadecimal.
Interval Box:	Data is written to AK4480 by this interval.
Step Box:	Data changes by this step.
Mode Select Box:	

If you check this check box, data reaches end data, and returns to start data.

[Example]	Start Data = 00, End Data = 09
Data flow:	00 01 02 03 04 05 06 07 08 09 09 08 07 06 05 04 03 02 01 00

If you do not check this check box, data reaches end data, but does not return to start data.

[Example]	Start Data = 00, End Data = 09
Data flow:	00 01 02 03 04 05 06 07 08 09

If you want to write the input data to AK4480, click [OK] button. If not, click [Cancel] button.

4. [Save] and [Open]

4-1. [Save]

Save the current register setting data. The extension of file name is “akr”.

(Operation flow)

- (1) Click [Save] Button.
- (2) Set the file name and push [Save] Button. The extension of file name is “akr”.

4-2. [Open]

The register setting data saved by [Save] is written to AK4480. The file type is the same as [Save].

(Operation flow)

- (1) Click [Open] Button.
- (2) Select the file (*.akr) and Click [Open] Button.

5. [Function3 Dialog]

The sequence of register setting can be set and executed.

(1) Click [F3] Button.

(2) Set the control sequence.

Set the address, Data and Interval time. Set “-1” to the address of the step where the sequence should be paused.

(3) Click [Start] button. Then this sequence is executed.

The sequence is paused at the step of Interval="-1". Click [START] button, the sequence restarts from the paused step.

This sequence can be saved and opened by [Save] and [Open] button on the Function3 window. The extension of file name is “aks”.

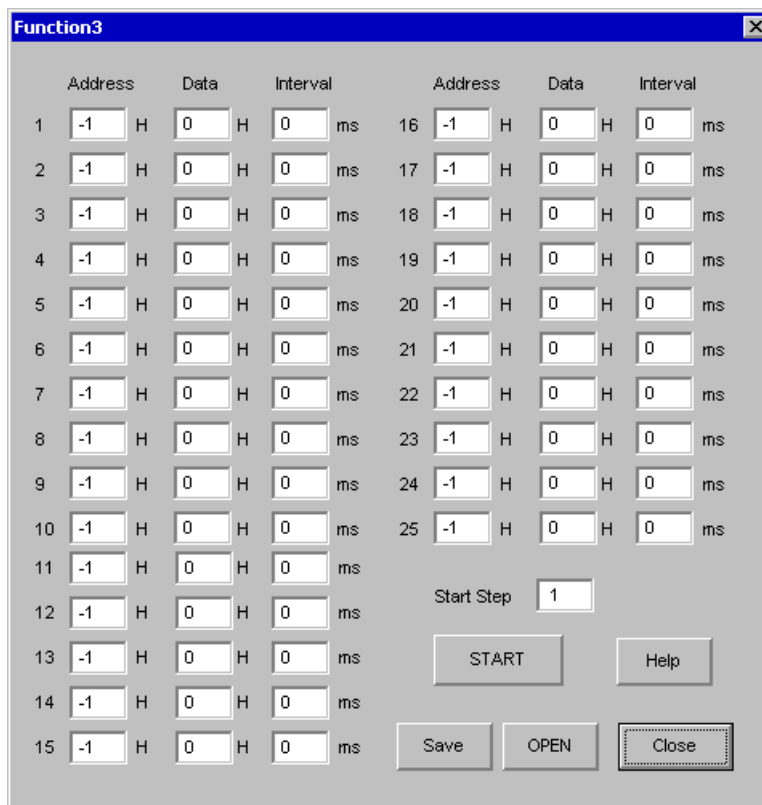

Figure 3. Window of [F3]

6. [Function4 Dialog]

The sequence that is created on [Function3] can be assigned to buttons and executed. When [F4] button is clicked, the window as shown in Figure 4 opens.

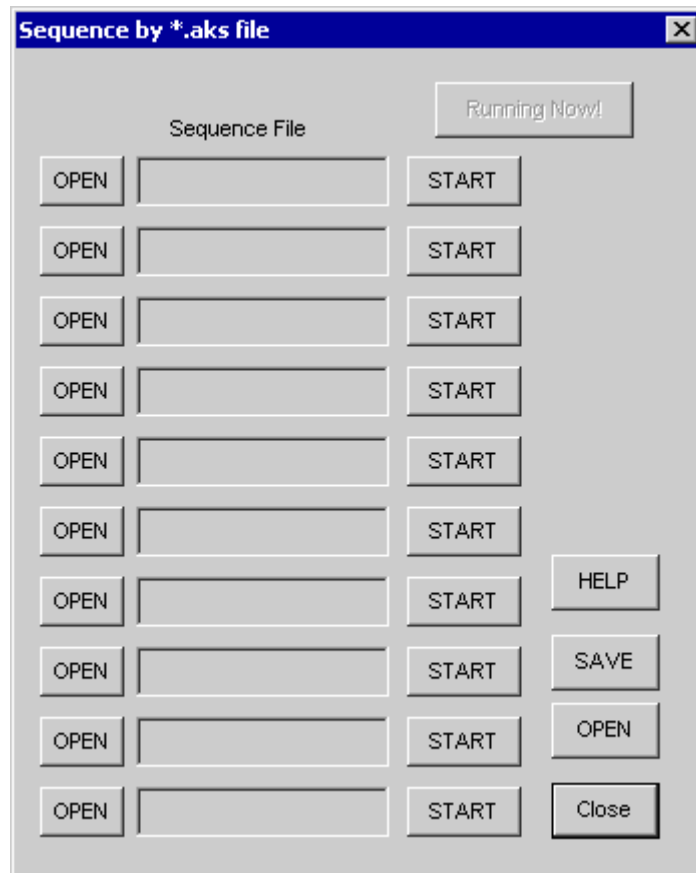

Figure 4. [F4] window

6-1. [OPEN] buttons on left side and [START] buttons

(1) Click [OPEN] button and select the sequence file (*.aks).

The sequence file name is displayed as shown in Figure 5

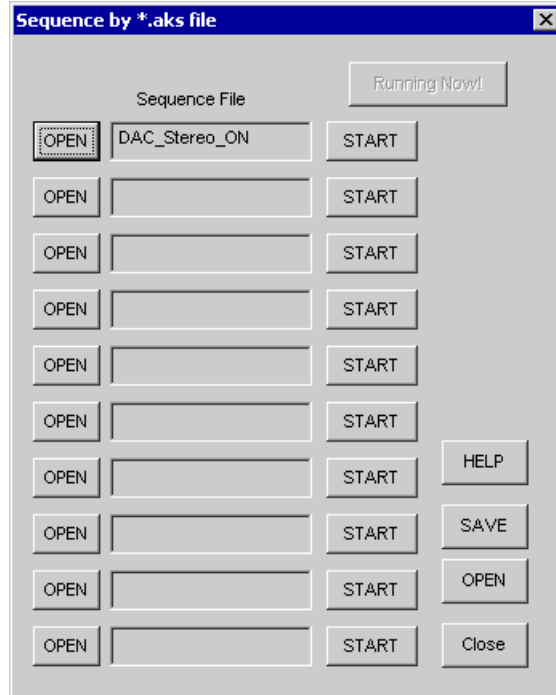

Figure 5. [F4] window(2)

(2) Click [START] button, then the sequence is executed.

6-2. [SAVE] and [OPEN] buttons on right side

[SAVE]: The sequence file names can assign be saved. The file name is *.ak4.

[OPEN]: The sequence file names assign that are saved in *.ak4 are loaded.

6-3. Note

- (1) This function doesn't support the pause function of sequence function.
- (2) All files need to be in same folder used by [SAVE] and [OPEN] function on right side.
- (3) When the sequence is changed in [Function3], the file should be loaded again in order to reflect the change.

7. [Function5 Dialog]

The register setting that is created by [SAVE] function on main window can be assigned to buttons and executed. When [F5] button is clicked, the following window as shown in Figure 6 opens.

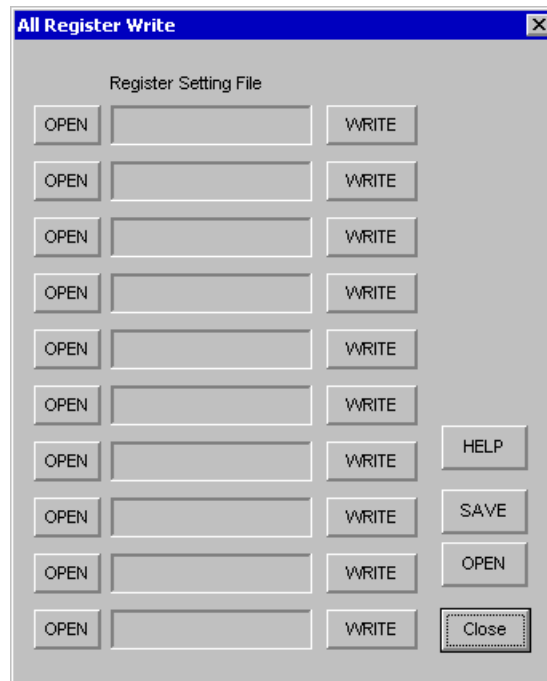

Figure 6. [F5] window

7-1. [OPEN] buttons on left side and [WRITE] button

- (1) Click [OPEN] button and select the register setting file (*.akr).
- (2) Click [WRITE] button, then the register setting is executed.

7-2. [SAVE] and [OPEN] buttons on right side

[SAVE]: The register setting file names assign can be saved. The file name is *.ak5.

[OPEN]: The register setting file names assign that are saved in *.ak5 are loaded.

7-3. Note

- (1) All files need to be in same folder used by [SAVE] and [OPEN] function on right side.
- (2) When the register setting is changed by [Save] Button in main window, the file should be loaded again in order to reflect the change.

測定結果

[Measurement condition]

- Measurement unit : Audio Precision System two Cascade (AP2)
- MCLK : 512fs (44.1 kHz), 256fs (96 kHz), 128fs (192 kHz)
- BICK : 64fs
- fs : 44.1kHz, 96kHz, 192kHz
- Bit : 24bit
- Power Supply : AVDD= DVDD=5V
- Interface : Internal DIR
- Temperature : Room
- Operational Amplifiers : LME49710NA

fs=44.1kHz

Parameter	Input signal	Measurement filter	Results (Lch / Rch)
S/(N+D)	1kHz, 0dB	20kLPF	108.3/107.5
DR	1kHz, -60dB	20kLPF, A-weighted	114.2/114.2
S/N	"0" data	20kLPF, A-weighted	114.3/114.3

fs=96kHz

Parameter	Input signal	Measurement filter	Results (Lch / Rch)
S/(N+D)	1kHz, 0dB	40kLPF	106.0/105.8
DR	1kHz, -60dB	40kLPF, A-weighted	114.2/114.2
S/N	"0" data	40kLPF, A-weighted	114.3/114.3

fs=192kHz

Parameter	Input signal	Measurement filter	Results (Lch / Rch)
S/(N+D)	1kHz, 0dB	40kLPF	106.0/105.5
DR	1kHz, -60dB	40kLPF, A-weighted	113.8/114.0
S/N	"0" data	40kLPF, A-weighted	114.3/114.3

fs=192kHz

Parameter	Input signal	Measurement filter	Results (Lch / Rch)
S/(N+D)	1kHz, 0dB	80kLPF	102.2/102.1
DR	1kHz, -60dB	80kLPF, A-weighted	113.8/114.0
S/N	"0" data	80kLPF, A-weighted	114.3/114.3

プロット

(DAC fs=44.1KHz)

AKM

AK4480 FFT 0dB
fs=44.1kHz,fin=1kHz

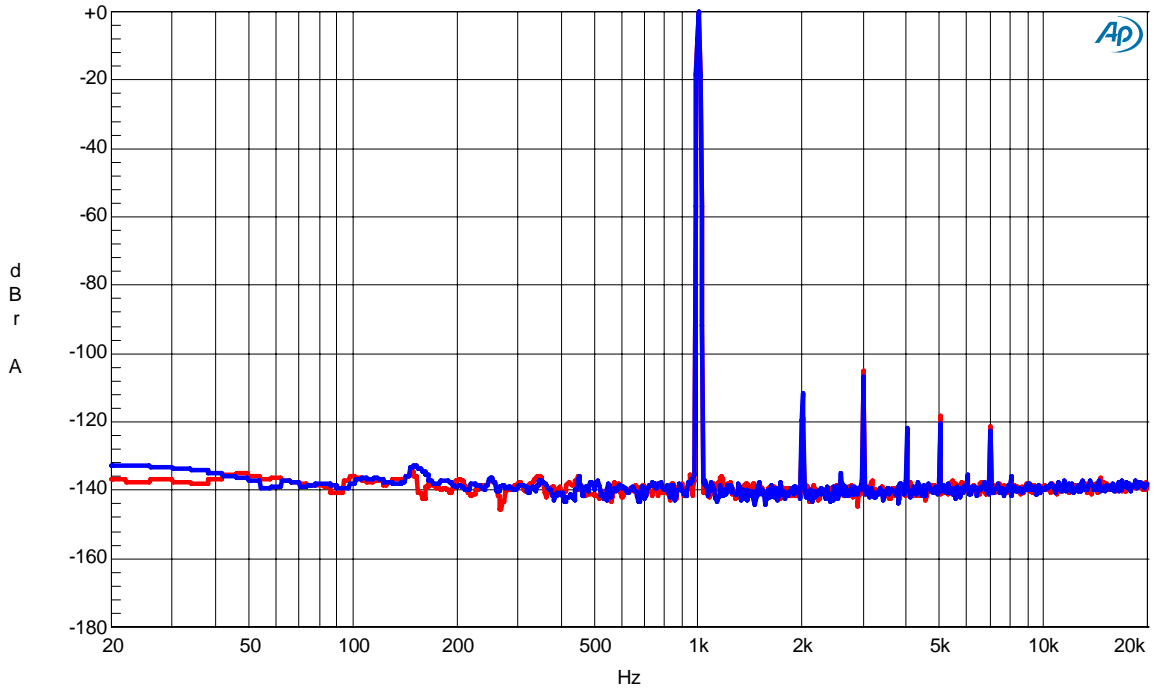

Figure 7. FFT (0dB)

AKM

AK4480 FFT -60dB
fs=44.1kHz,fin=1kHz

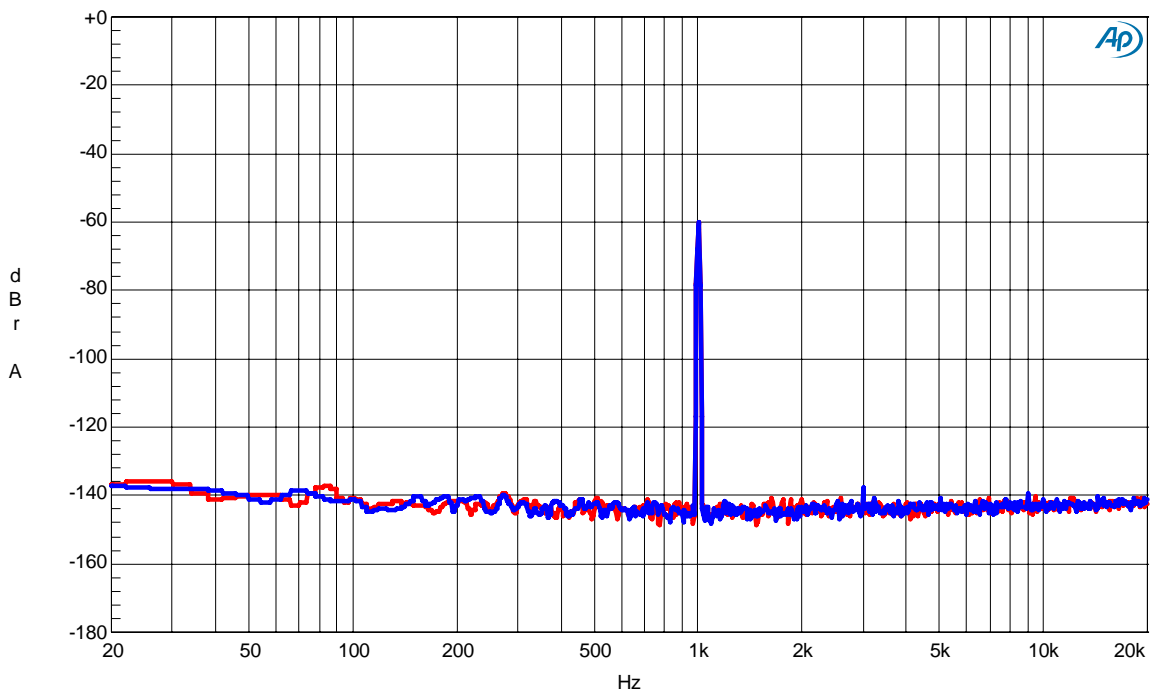

Figure 8. FFT (-60dB)

(DAC fs=44.1KHz)

AKM

AK4480 FFT No Signal
fs=44.1kHz,fin=1kHz

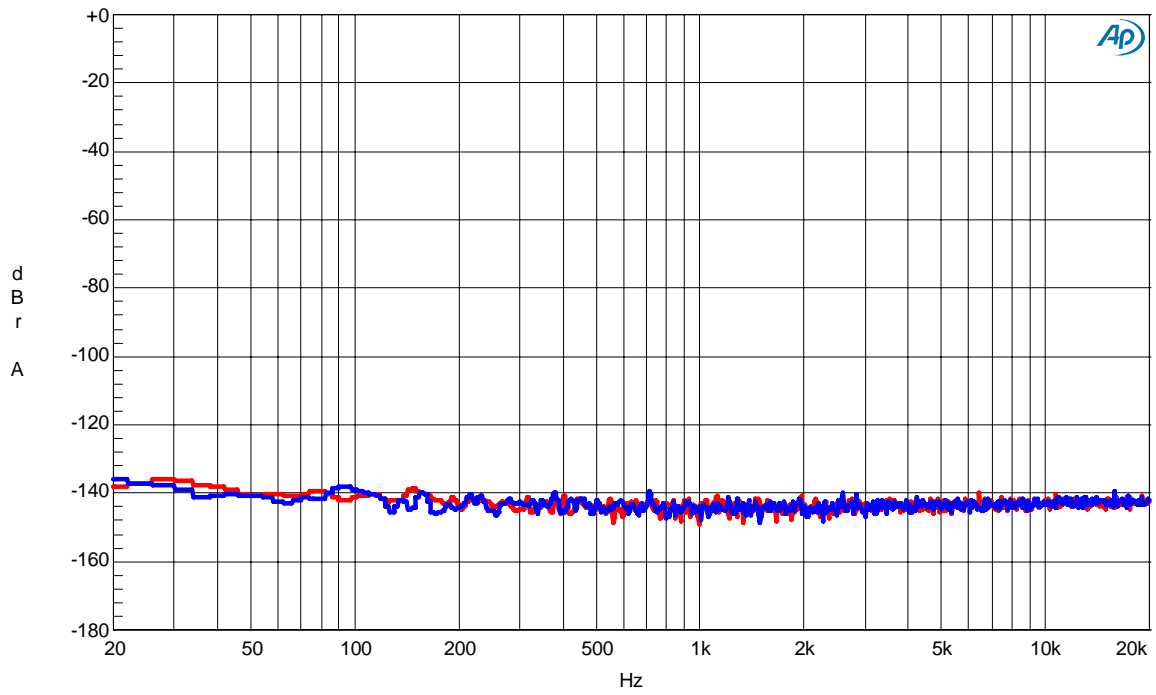

Figure 9. FFT (No Signal)

AKM

AK4480 FFT Out of Band Noise
fs=44.1kHz,fin=1kHz

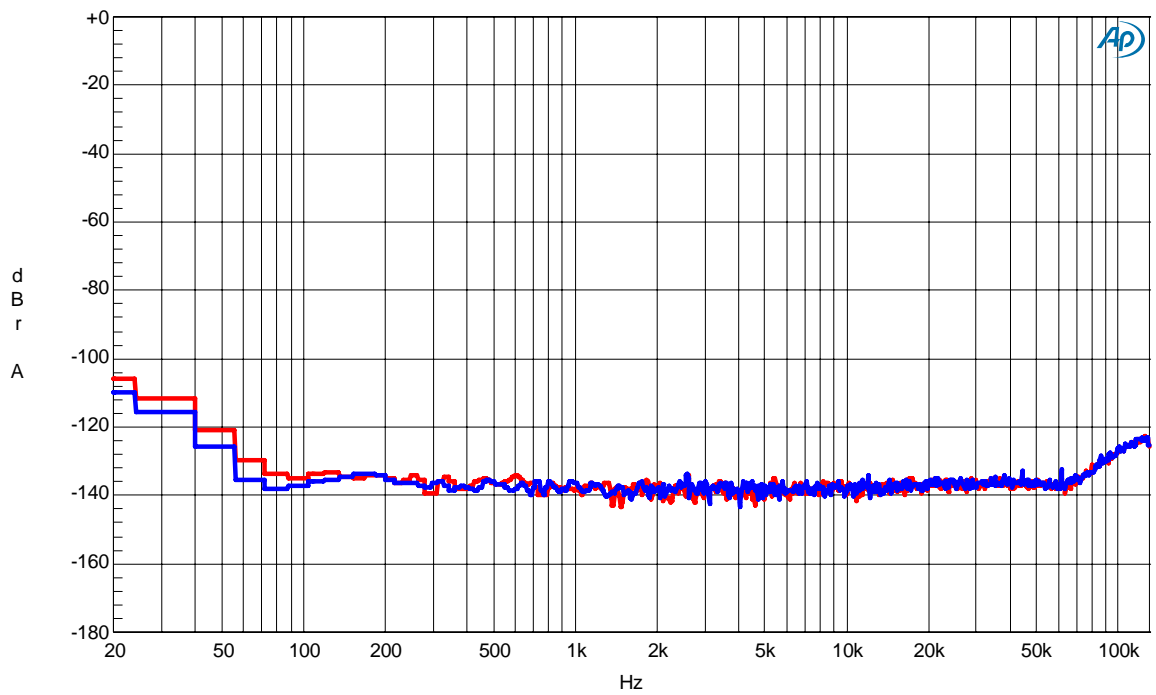

Figure 10. FFT (Out of Band Noise)

(DAC fs=44.1KHz)

AKM

AK4480 Input Level vs THD+N
fs=44.1kHz,fin=1kHz

Figure 11. THD + N vs. Input Level

AKM

AK4480 Input Frequency vs THD+N
fs=44.1KHz,0dB

Figure 12. THD + N vs. Input Frequency

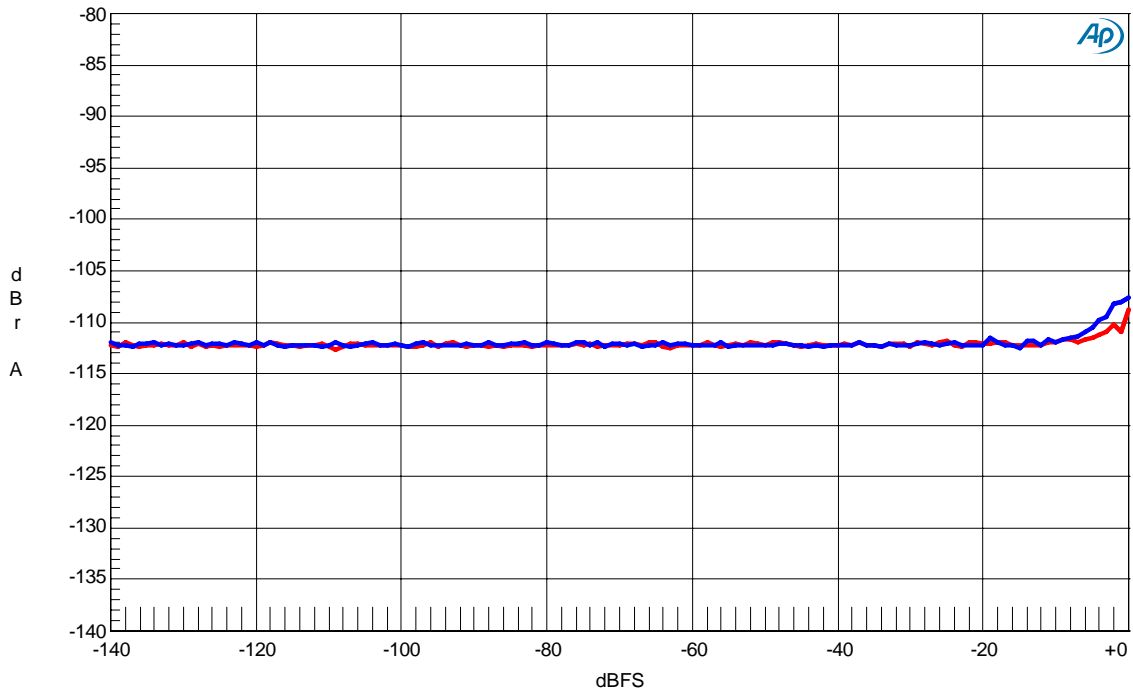
(DAC fs=44.1KHz)

AKM

AK4480 Linearity
fs=44.1KHz, fin=1KHz

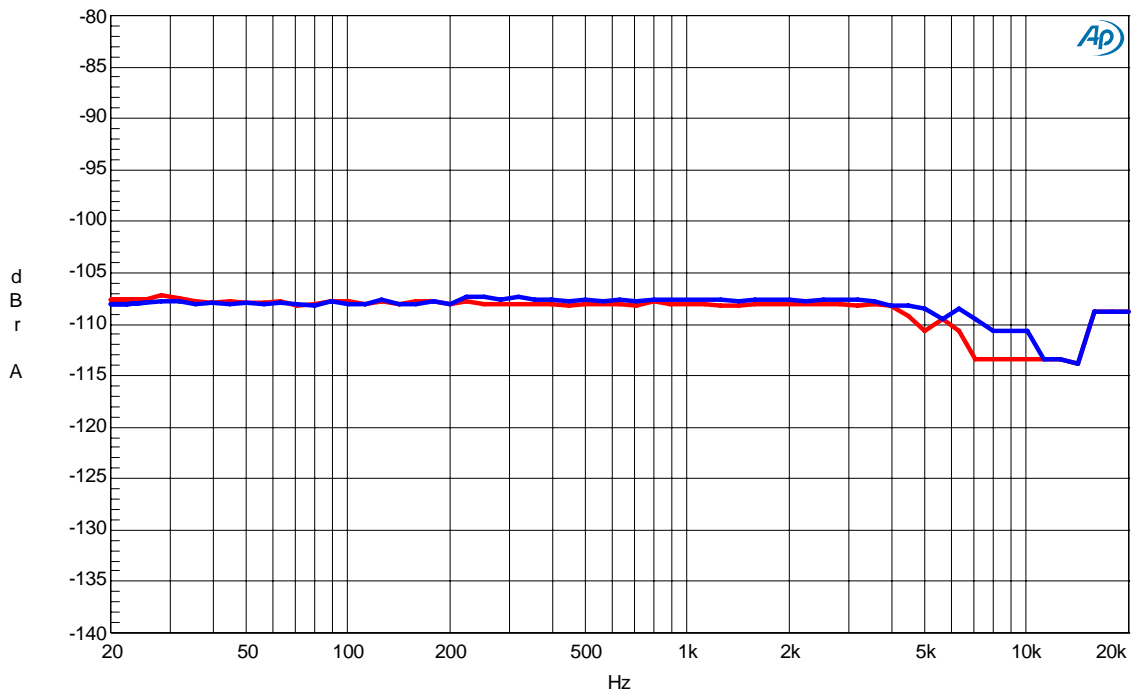
Figure 13. Linearity

AKM

AK4480 Frequency Response
fs=44.1KHz, 0dB

Figure 14.. Frequency Response

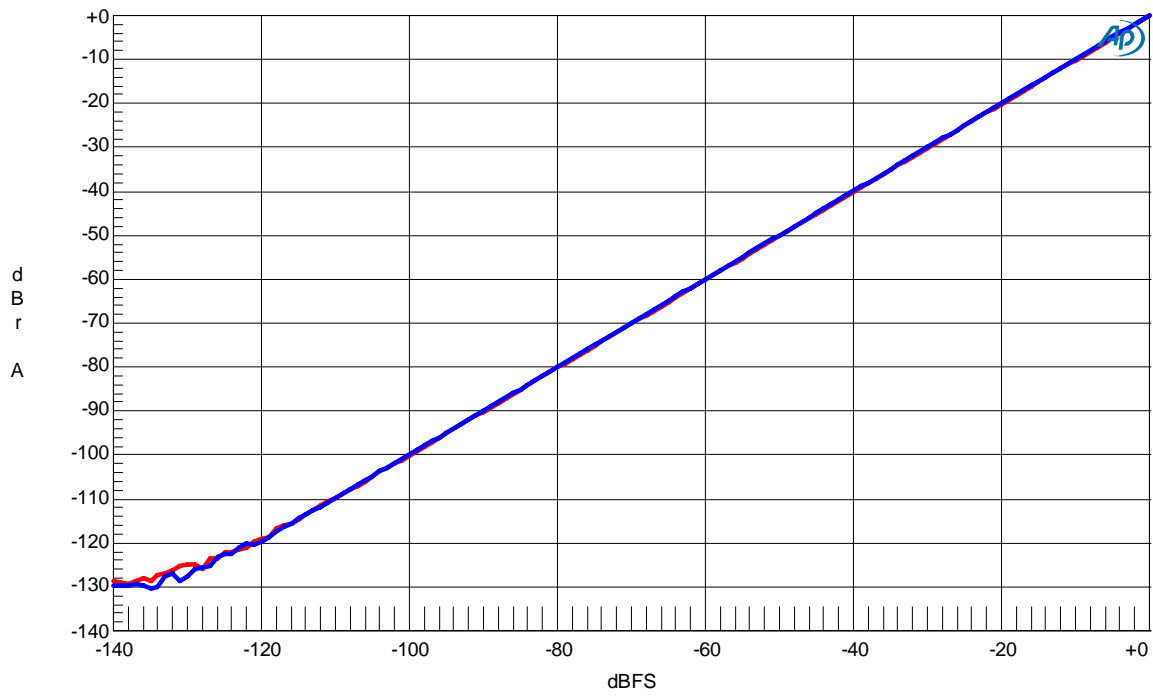
(DAC fs=44.1KHz)

AK4480 Crosstalk
fs=44.1KHz,0dB

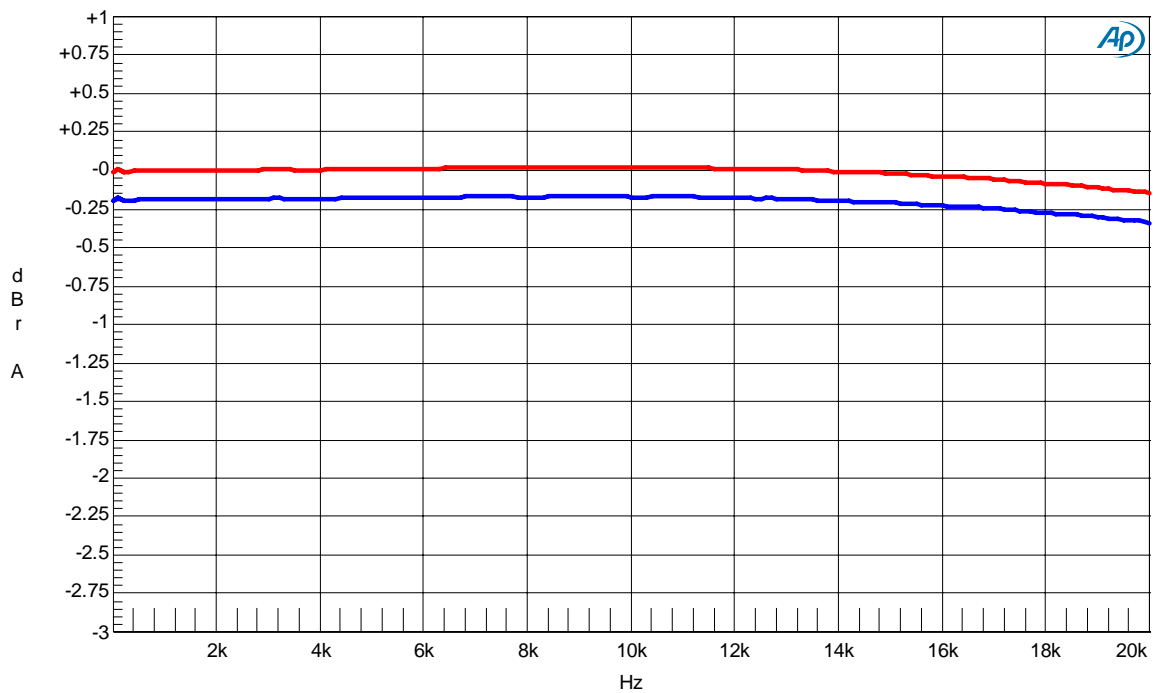
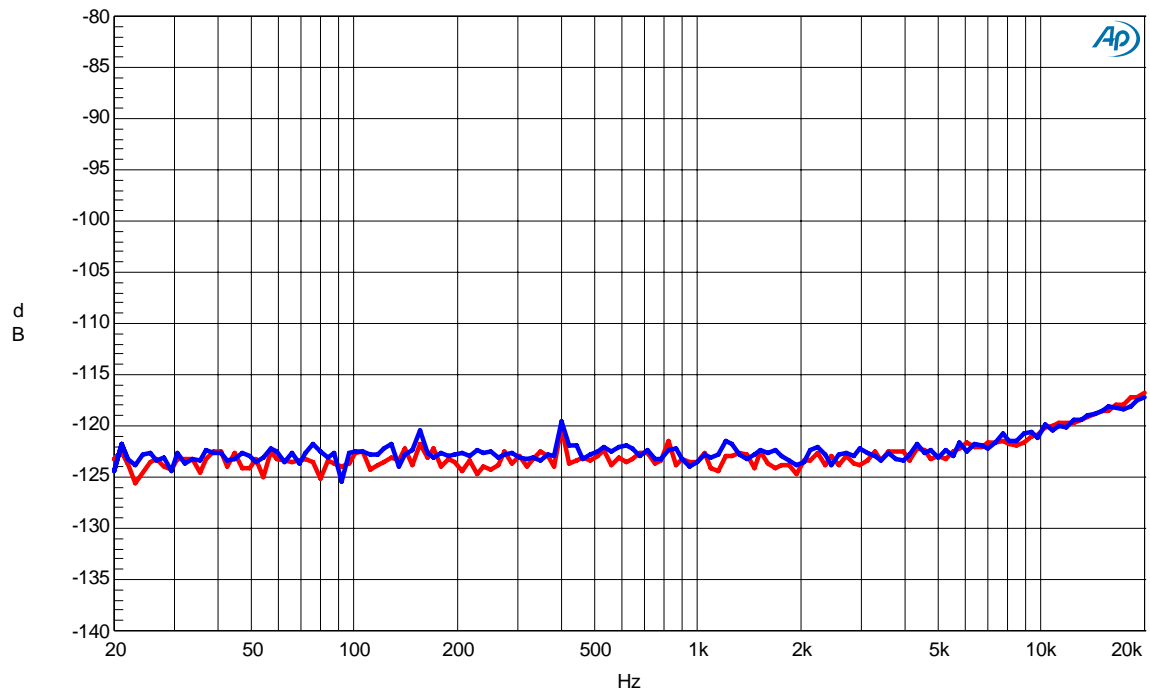

Figure 15. Crosstalk

(DAC fs=96KHz)

AKM

AK4480 FFT 0dB
fs=96kHz,fin=1kHz

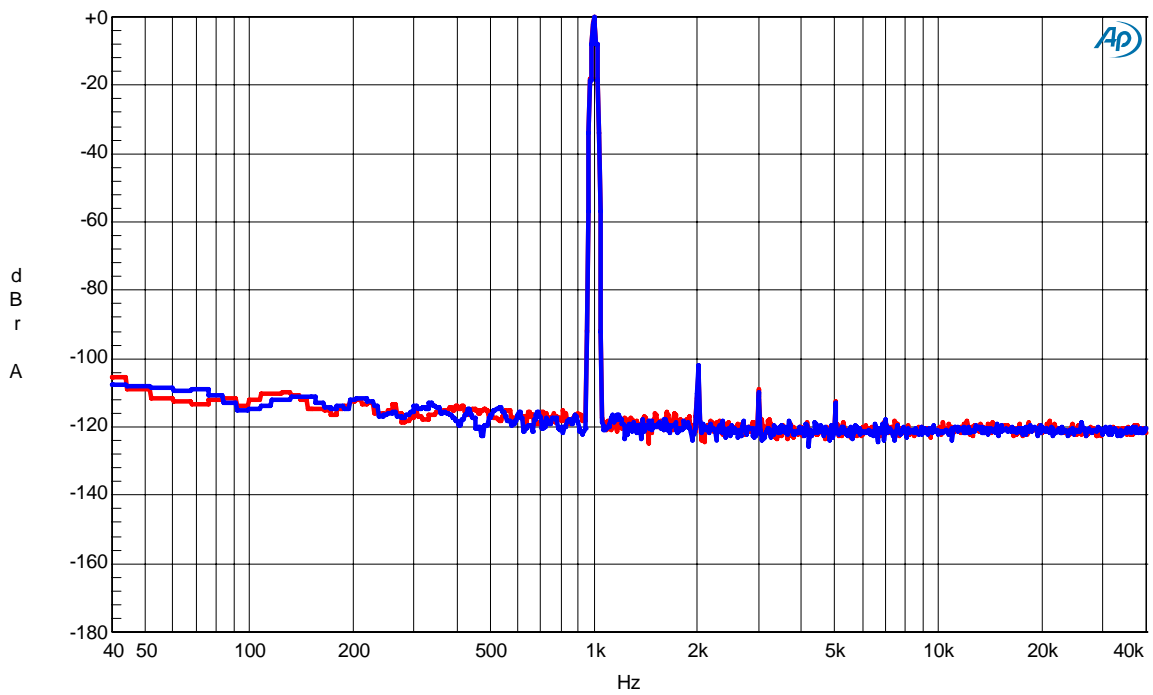

Figure 16.FFT (0dB)

(DAC fs=96KHz)

AKM

AK4480 FFT Notch Filter On
fs=96kHz,fin=1kHz

Figure 17.FFT (Notch Filter=on)

AKM

AK4480 FFT -60dB
fs=96kHz,fin=1kHz

Figure 18.FFT (-60dB)

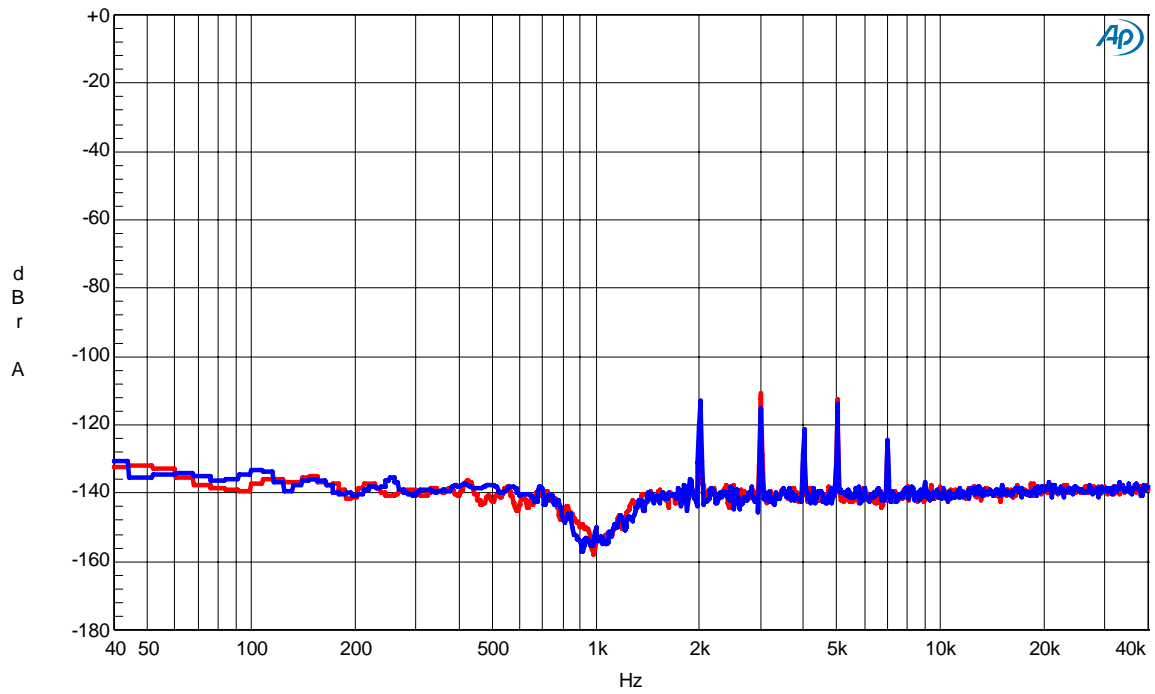
(DAC fs=96KHz)

AKM

AK4480 FFT No Signal
fs=96kHz,fin=1kHz

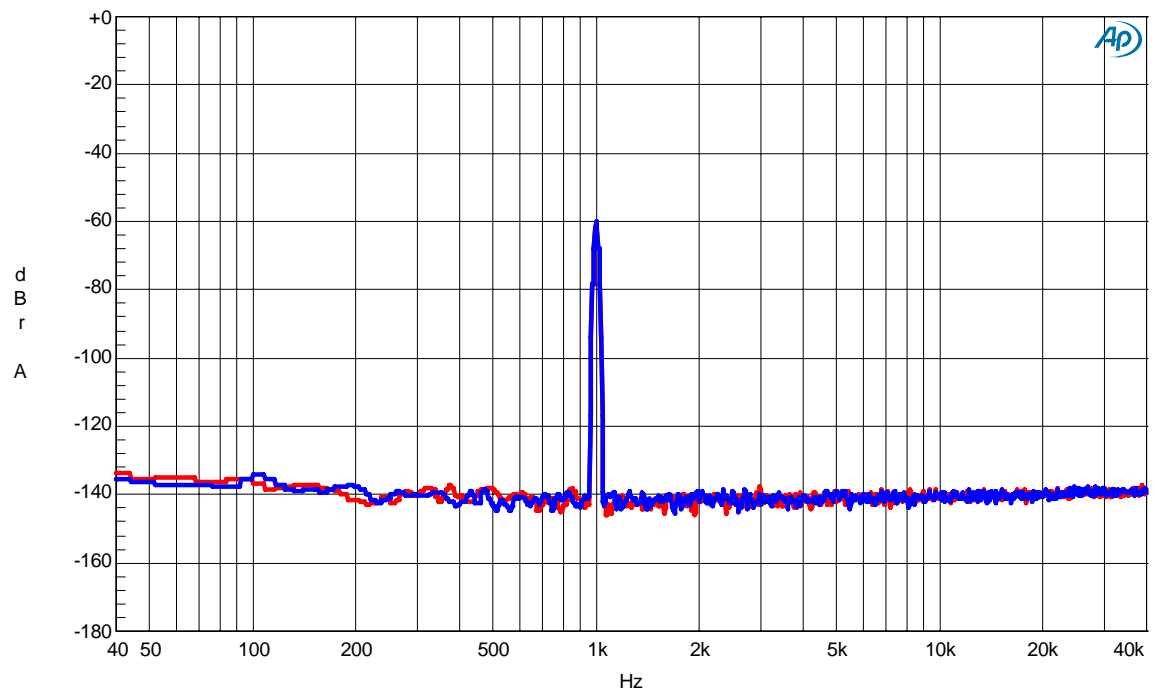
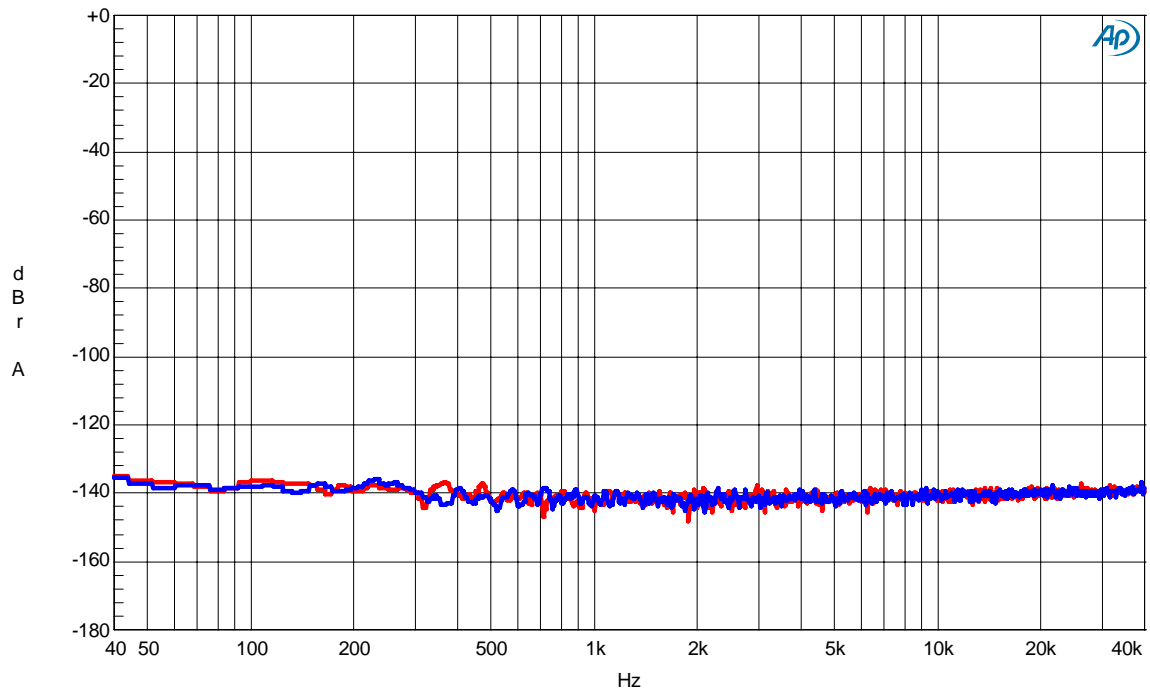

Figure 19.FFT (No Signal)

AKM

AK4480 Input Level vs THD+N
fs=96kHz,fin=1kHz

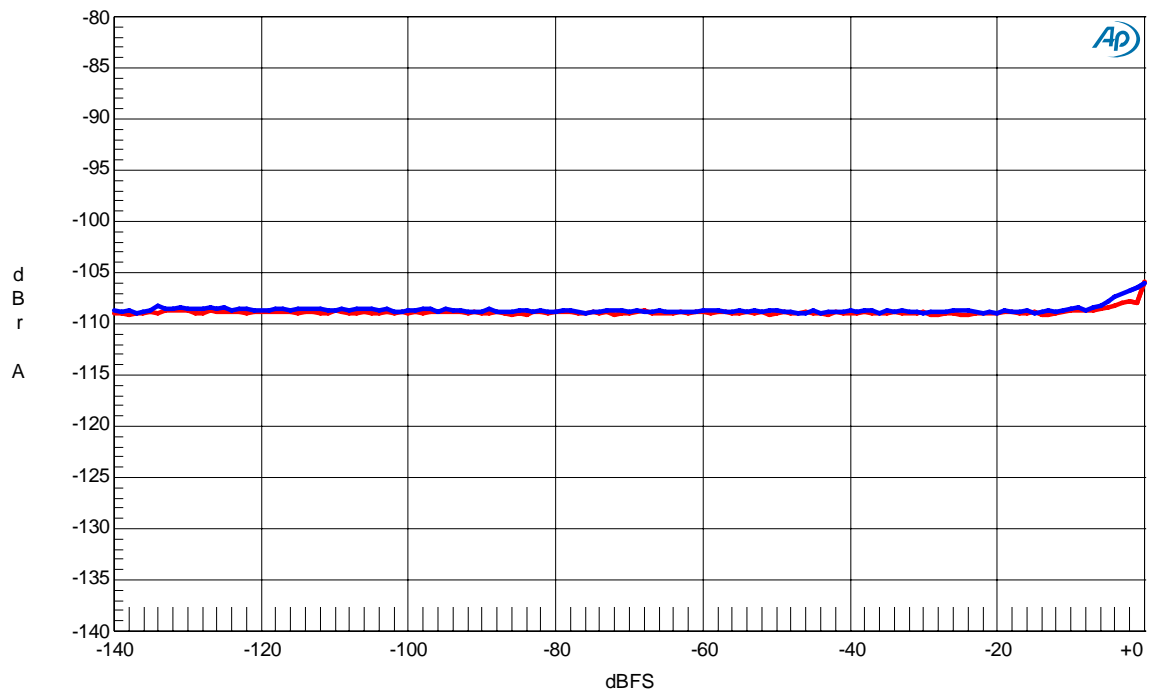

Figure 20.TH D + N vs. Input Level

(DAC fs=96KHz)

AKM

AK4480 Input Frequency vs THD+N
fs=96KHz,0dB

Figure 21. THD + N vs. Input Frequency

AKM

AK4480 Linearity
fs=96KHz,fin=1KHz

Figure 22. Linearity

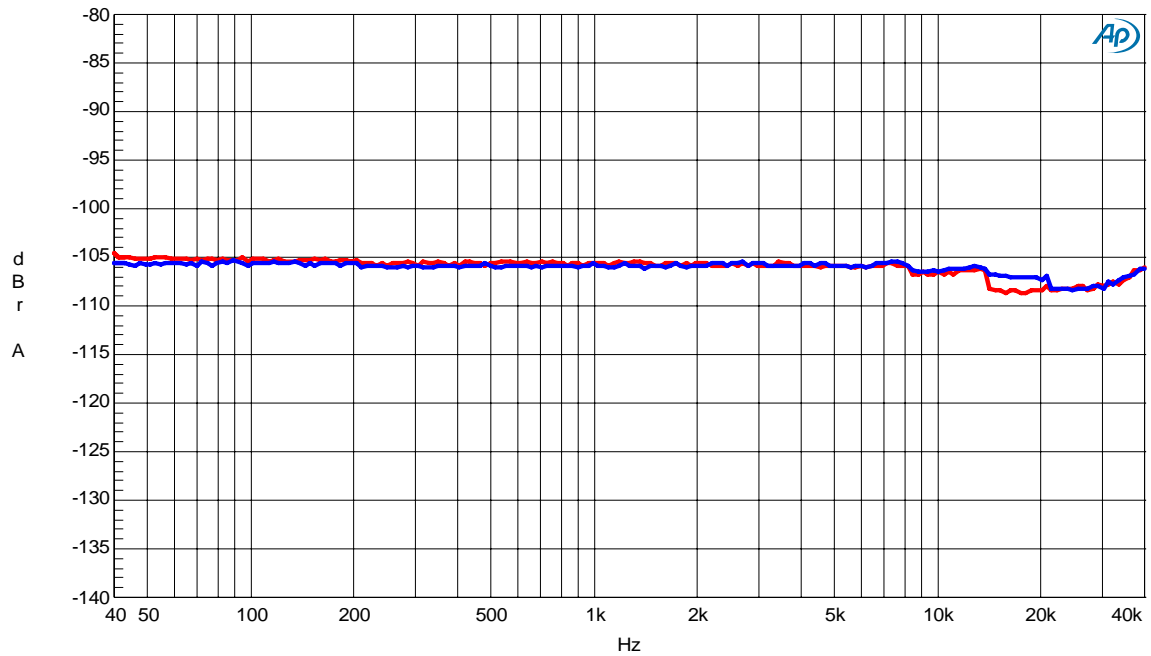
(DAC fs=96KHz)

AKM

AK4480 Frequency Response
fs=96KHz,0dB

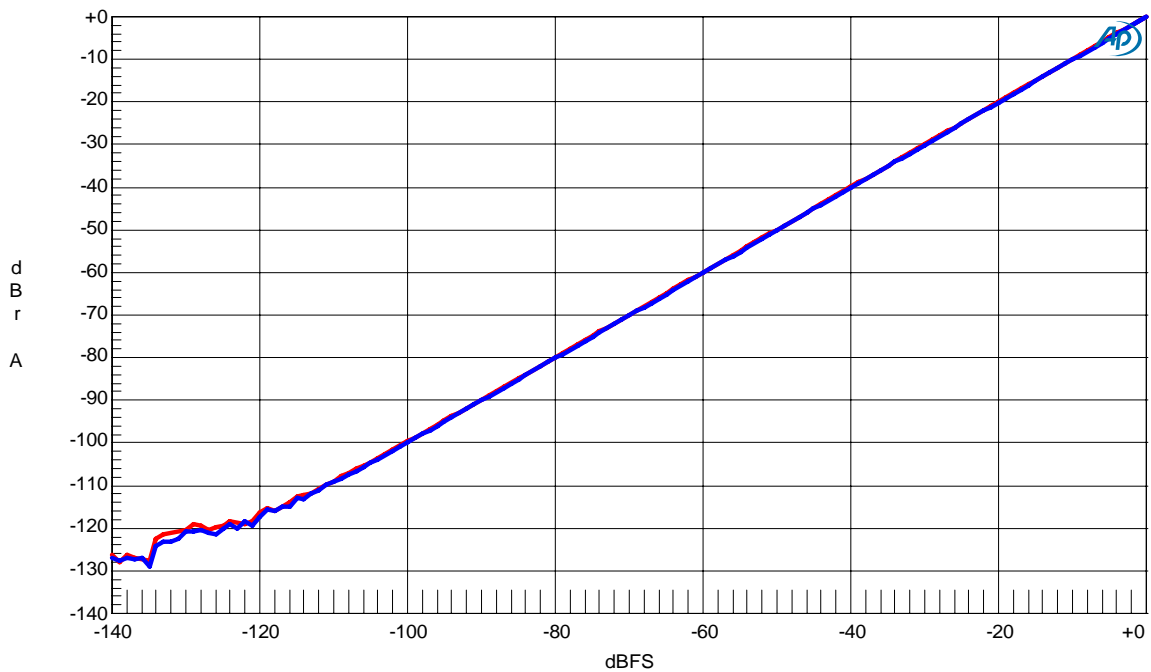
Figure 23.Frequency Response

AK4480 Crosstalk
fs=96KHz,0dB

Figure 24.Crosstalk

(DAC fs=192KHz)

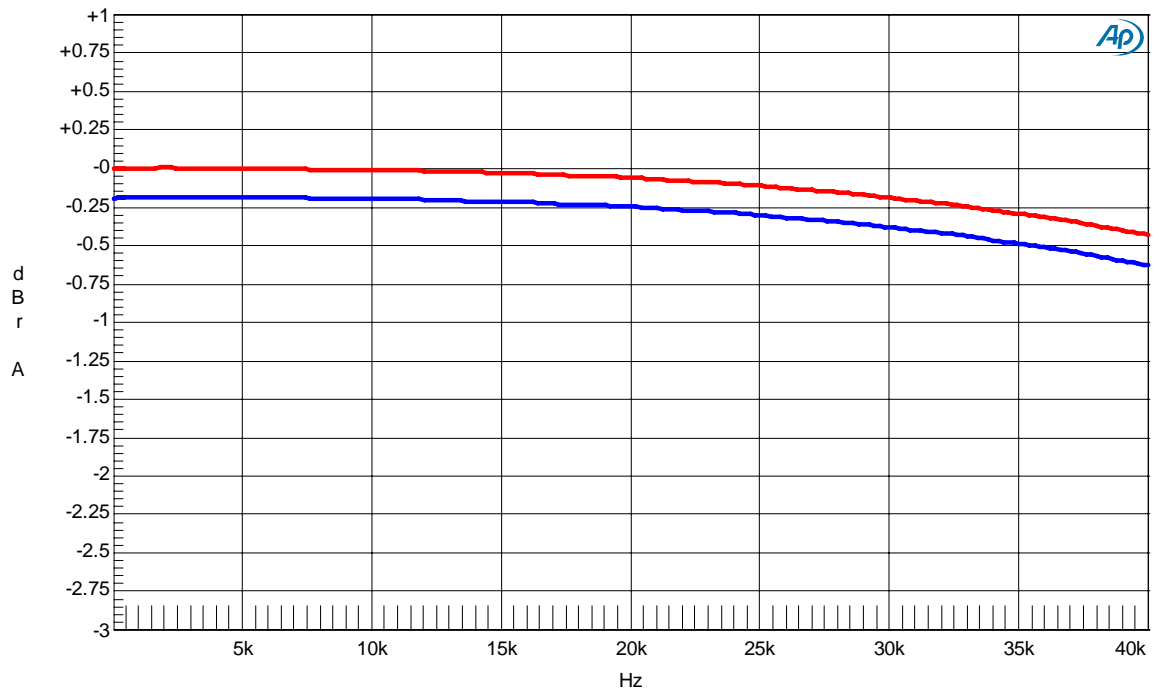
AKM

AK4480 FFT 0dB
fs=192kHz,fin=1kHz

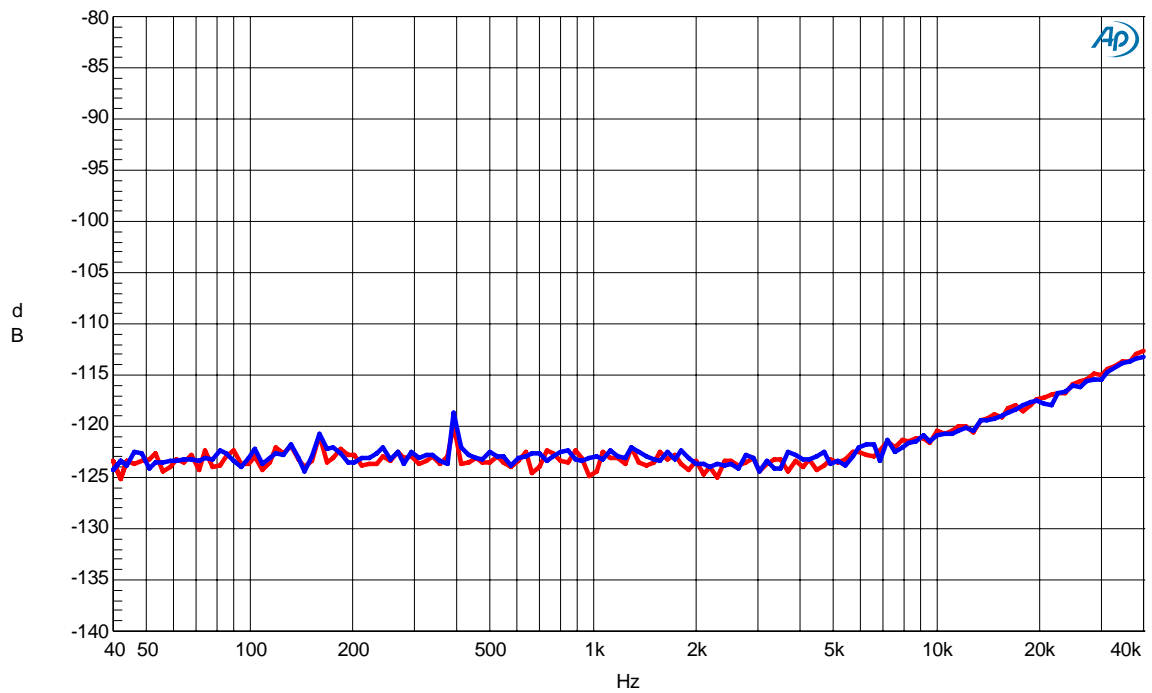
Figure 25.FFT(0dB)

AKM

AK4480 FFT Notch Filter On
fs=192kHz,fin=1kHz

Figure 26.FFT (Notch Filter=on)

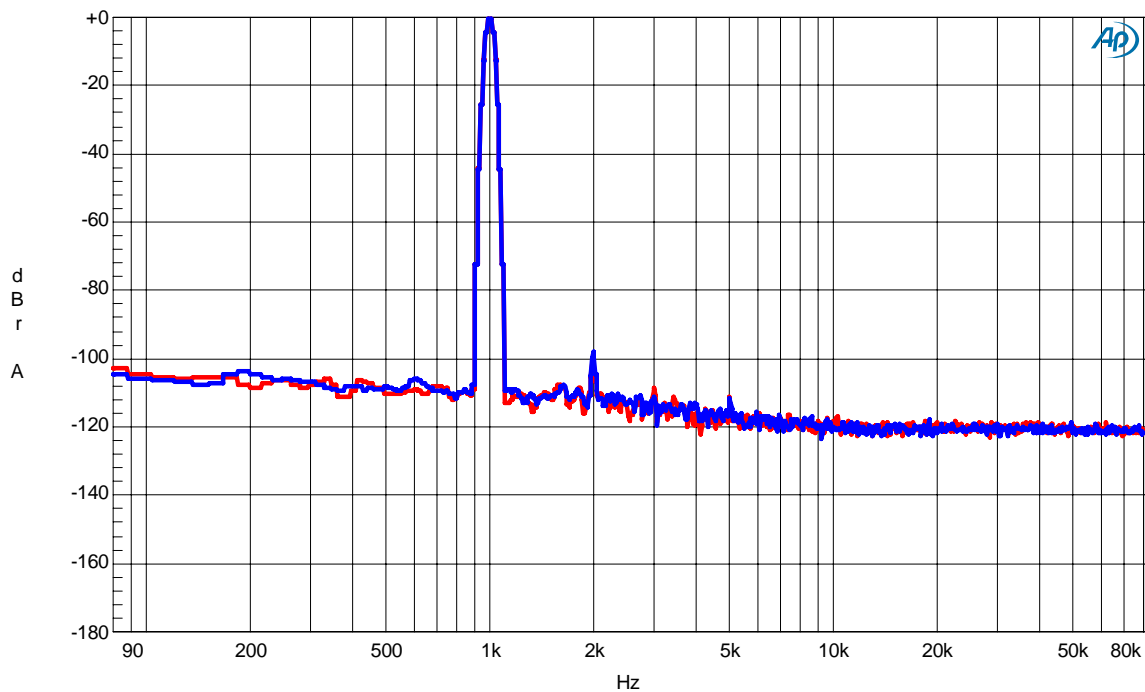
(DAC fs=192KHz)

AKM

AK4480 FFT -60dB
fs=192kHz,fin=1kHz

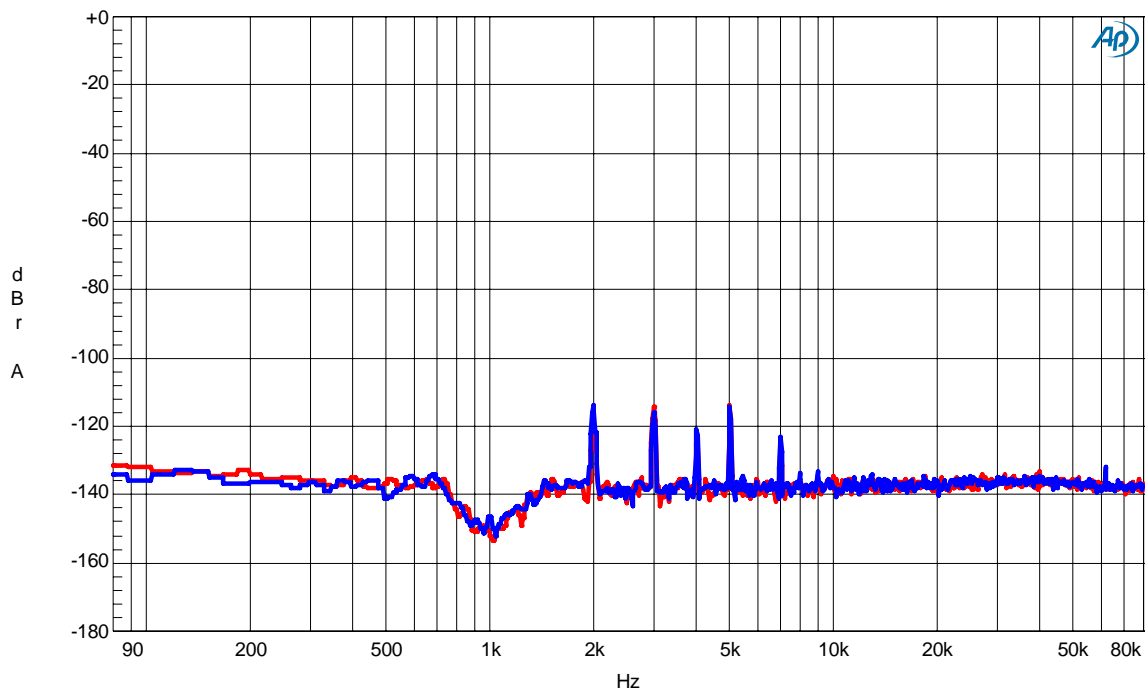
Figure 27.FFT(-60dB)

AKM

AK4480 FFT No Signal
fs=192kHz,fin=1kHz

Figure 28.FFT(No Signal)

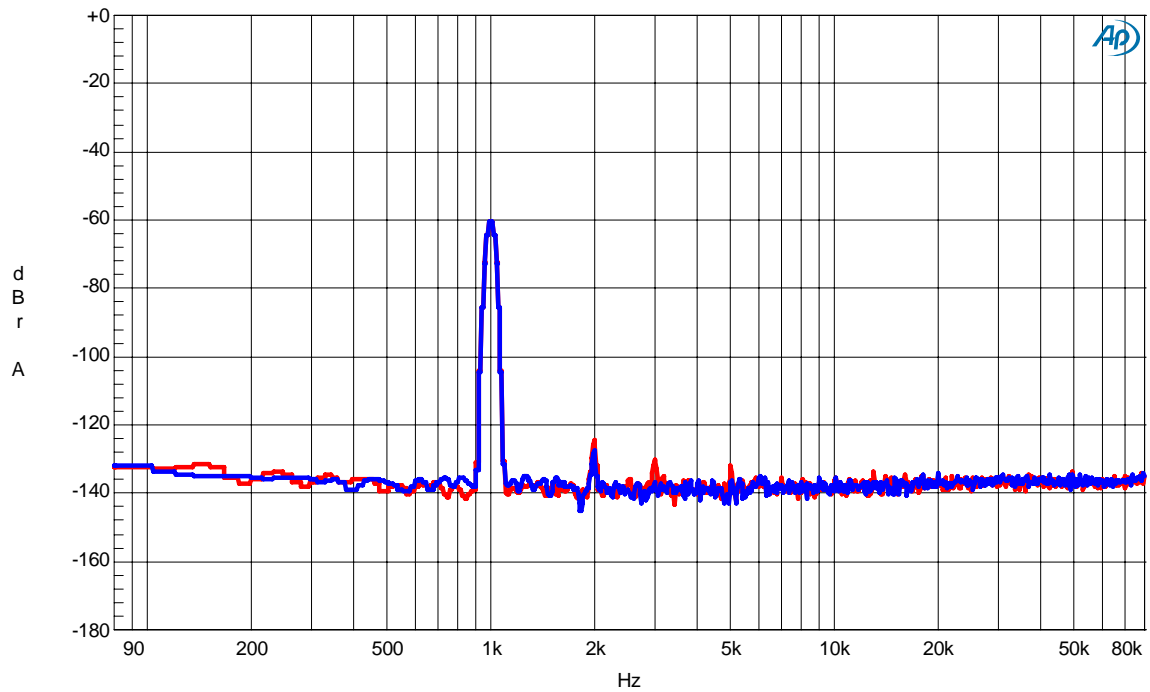
(DAC fs=192KHz)

AKM

AK4480 Input Level vs THD+N
fs=192kHz,fin=1kHz

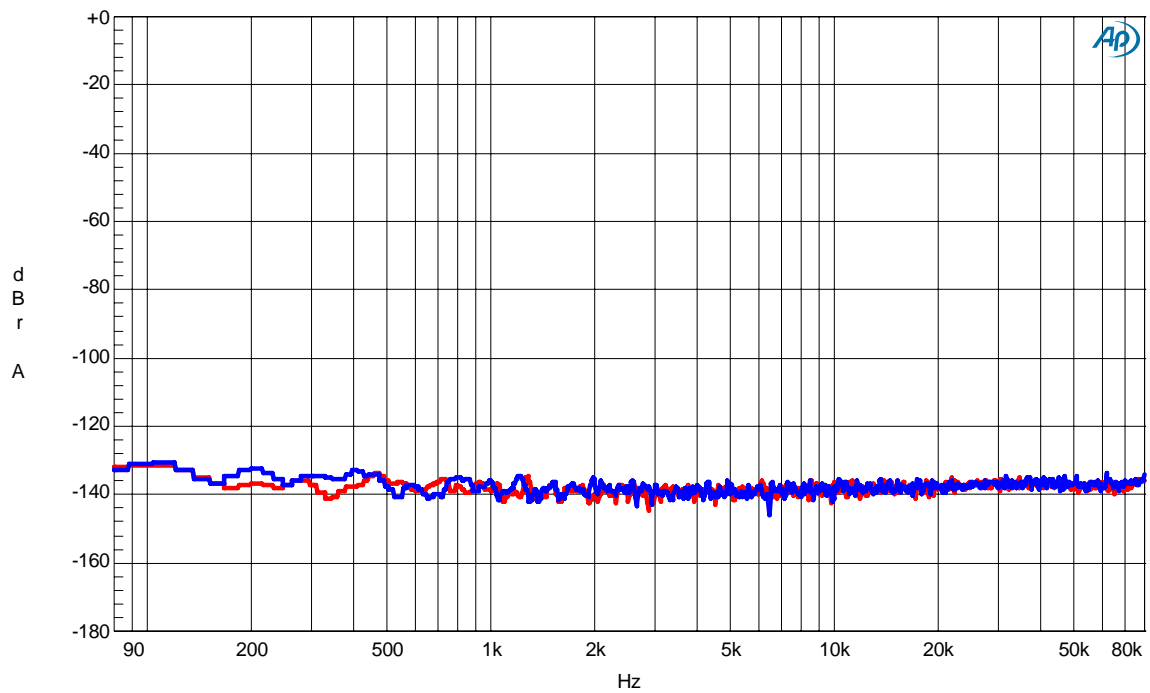
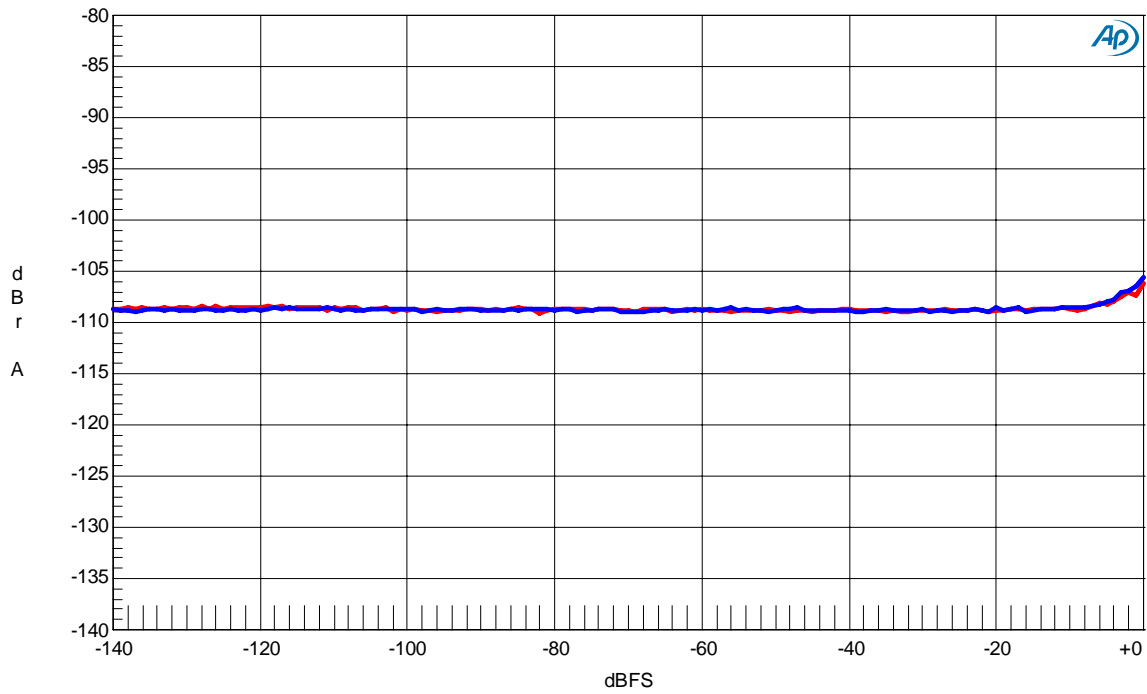

Figure 29. THD + N vs. Input Level

AKM

AK4480 Input Frequency vs THD+N
fs=192KHz,0dB

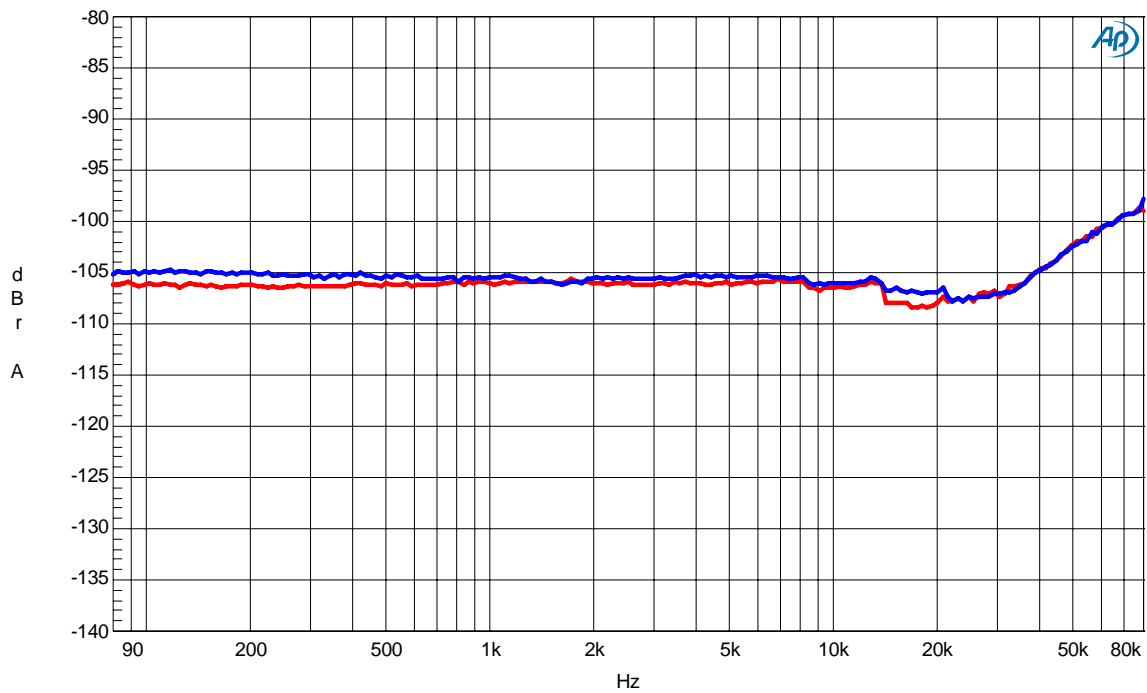

Figure 30. THD + N vs. Input Frequency

(DAC fs=192KHz)

AKM

AK4480 Linearity
fs=192KHz,fin=1KHz

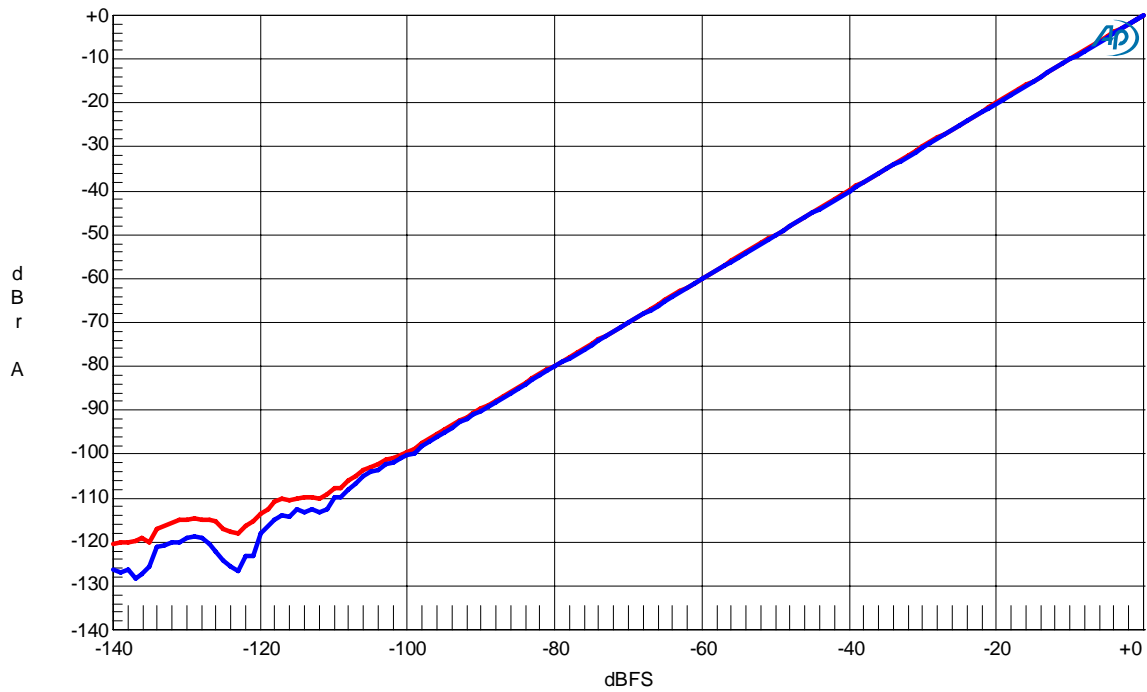

Figure 31.Linearity

AKM

AK4480 Frequency Response
fs=192KHz,0dB

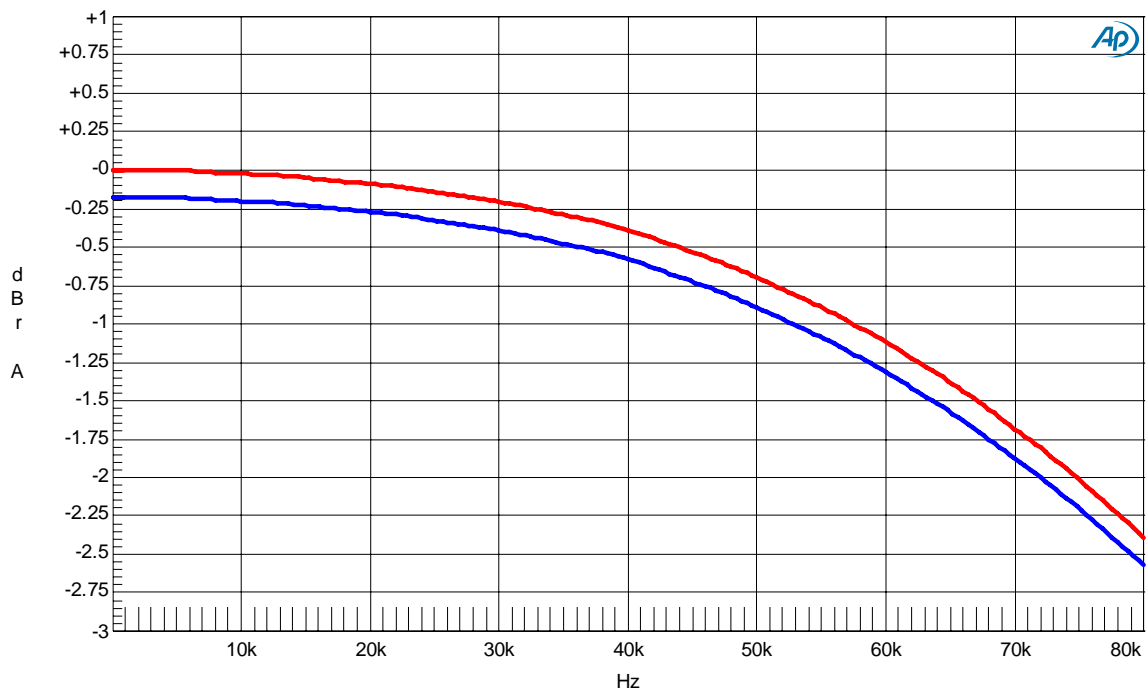

Figure 32.Frequency Response

(DAC fs=192KHz)

AK4480 Crosstalk
fs=192KHz,0dB

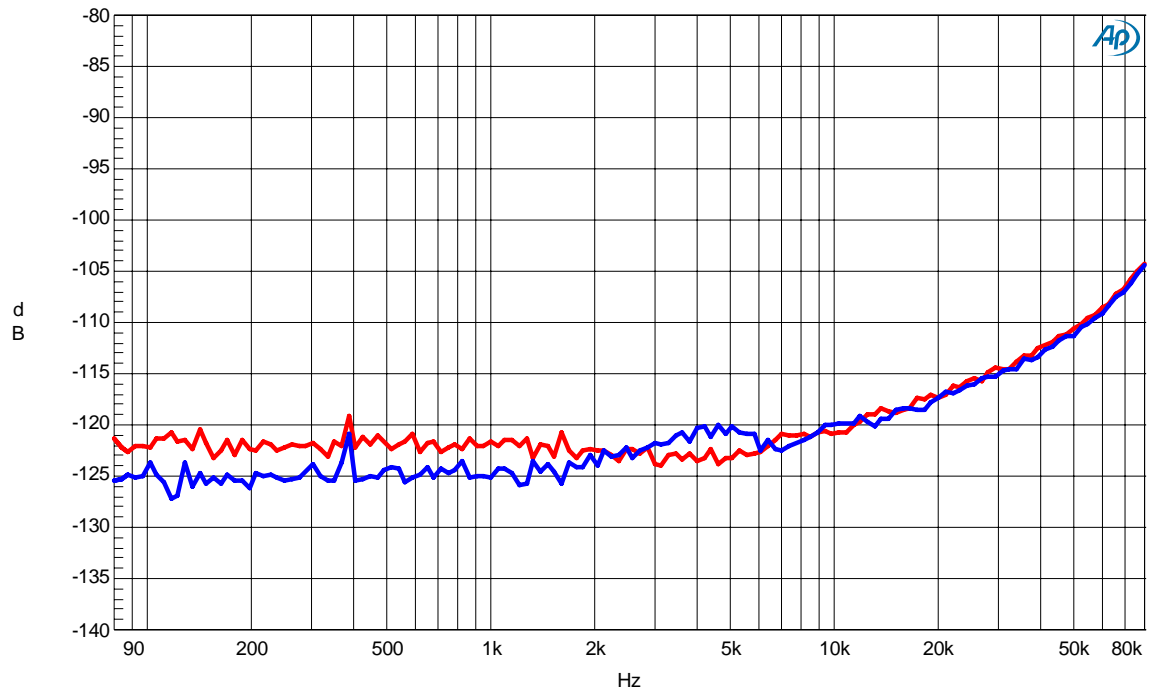

Figure 33.Crosstalk

Revision History

Date (yy/mm/dd)	Manual Revision	Board Revision	Reason	Page	Contents
08/02/18	KM097900	0	First edition		
09/04/14	KM097901	1	Modification	12~26	Device revision was changed.: Rev.A→Rev.B Update of measurement results. Add Plots.
09/11/25	KM097902	2	Modification	12~26	Device revision was changed.: Rev.B→Rev.D Update of measurement results and Plots.
			Modification	28	Circuit diagram was changed. R67:Open.

IMPORTANT NOTICE

- These products and their specifications are subject to change without notice.
When you consider any use or application of these products, please make inquiries the sales office of Asahi Kasei Microdevices Corporation (AKM) or authorized distributors as to current status of the products.
- AKM assumes no liability for infringement of any patent, intellectual property, or other rights in the application or use of any information contained herein.
- Any export of these products, or devices or systems containing them, may require an export license or other official approval under the law and regulations of the country of export pertaining to customs and tariffs, currency exchange, or strategic materials.
- AKM products are neither intended nor authorized for use as critical components^{Note1)} in any safety, life support, or other hazard related device or system^{Note2)}, and AKM assumes no responsibility for such use, except for the use approved with the express written consent by Representative Director of AKM. As used here:
 - Note1) A critical component is one whose failure to function or perform may reasonably be expected to result, whether directly or indirectly, in the loss of the safety or effectiveness of the device or system containing it, and which must therefore meet very high standards of performance and reliability.
 - Note2) A hazard related device or system is one designed or intended for life support or maintenance of safety or for applications in medicine, aerospace, nuclear energy, or other fields, in which its failure to function or perform may reasonably be expected to result in loss of life or in significant injury or damage to person or property.
- It is the responsibility of the buyer or distributor of AKM products, who distributes, disposes of, or otherwise places the product with a third party, to notify such third party in advance of the above content and conditions, and the buyer or distributor agrees to assume any and all responsibility and liability for and hold AKM harmless from any and all claims arising from the use of said product in the absence of such notification.

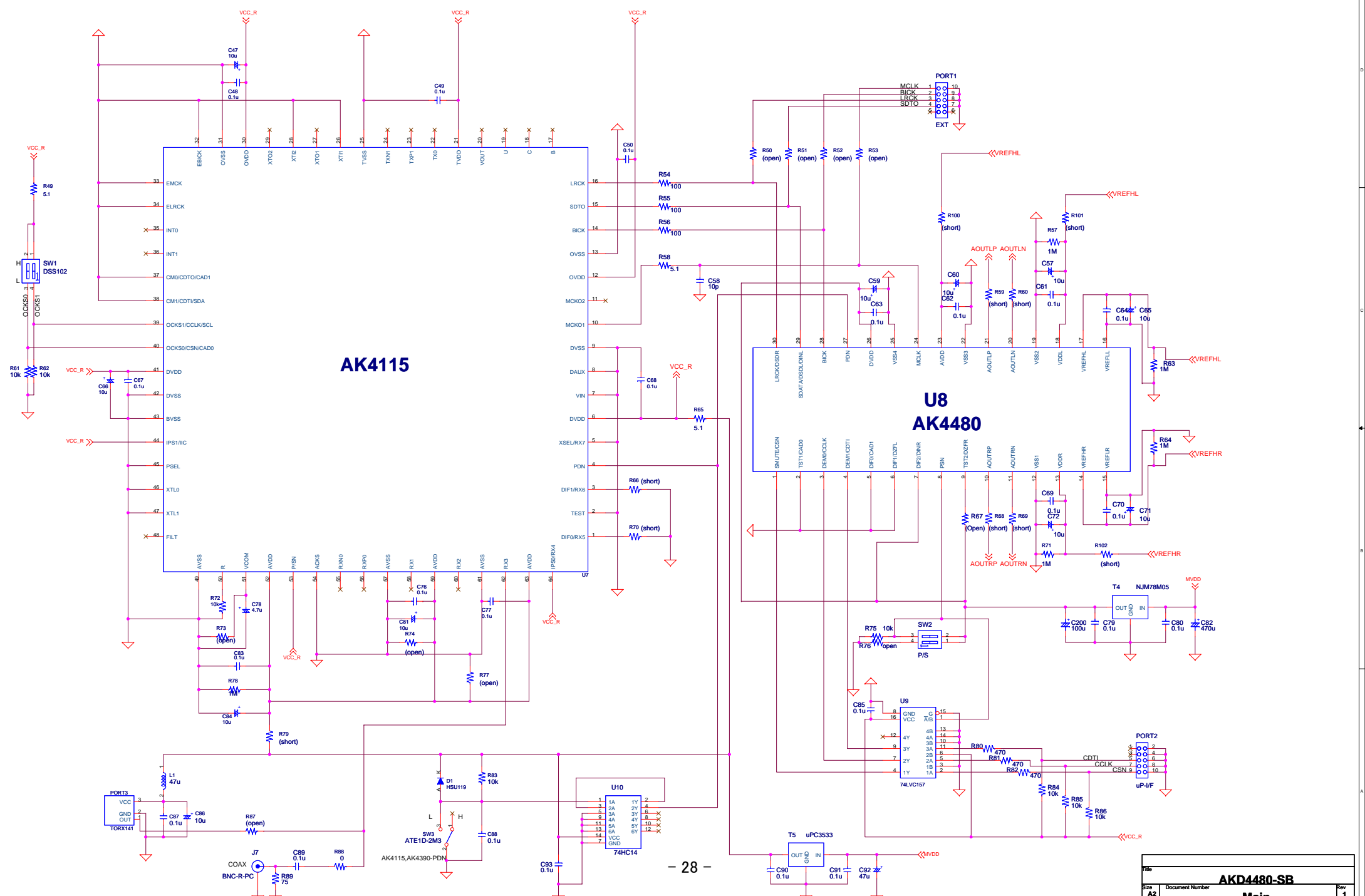

File	AKD4480-SB		
Size	A2	Document Number	
		Main	Rev 1
Date:	Wednesday, November 25, 2009 12:00	1	of 3

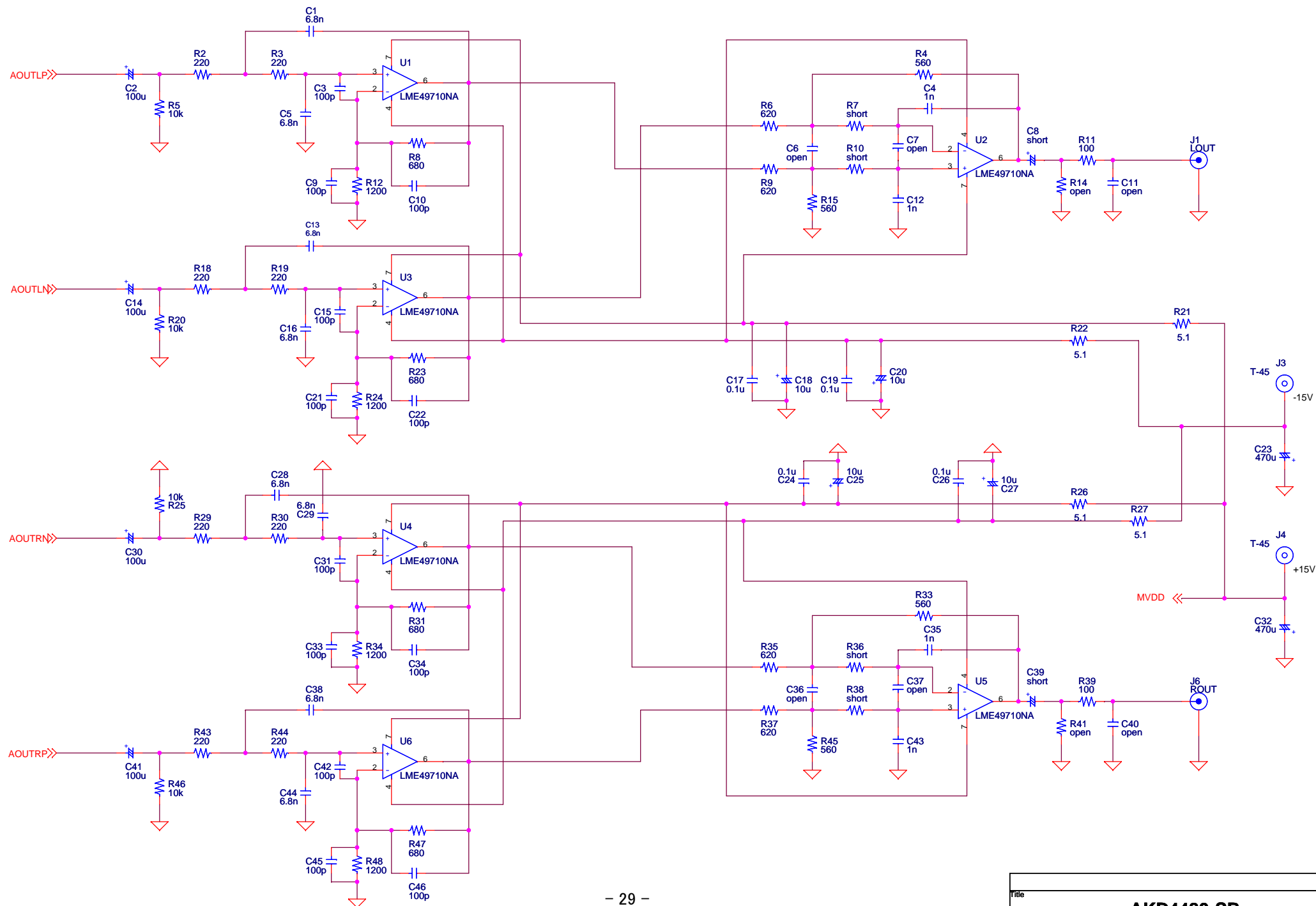

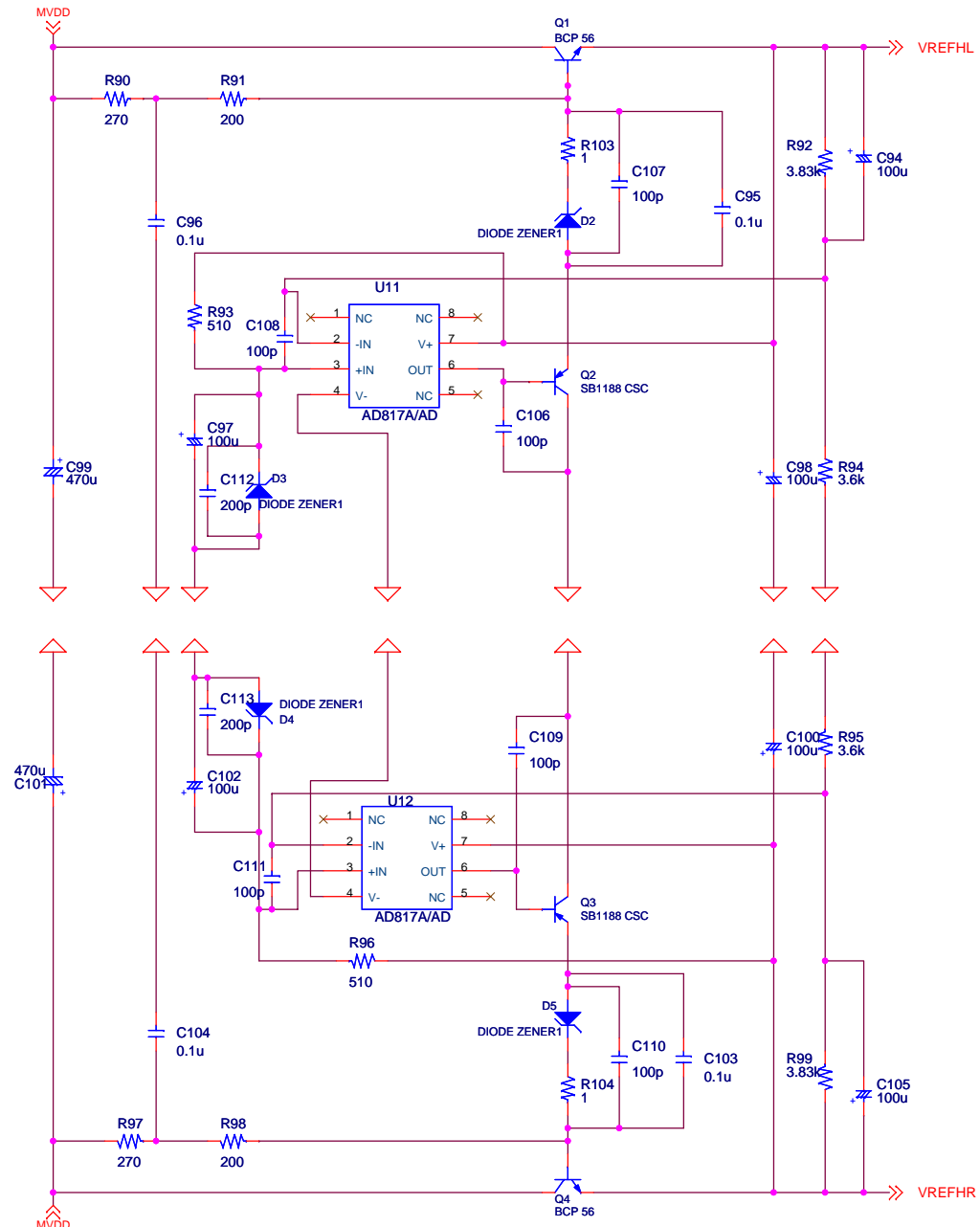

Title			AKD4480-SB		
Size	Document Number				Rev
A3					1
Date: Wednesday, November 25, 2009			Sheet 3 of 3		